

Addressable Fire Alarm Control Panel
NFW-50X
Manual



Fire Alarm & Emergency Communication System Limitations

While a life safety system may lower insurance rates, it is not a substitute for life and property insurance!

An automatic fire alarm system—typically made up of smoke detectors, heat detectors, manual pull stations, audible warning devices, and a fire alarm control panel (FACP) with remote notification capability—can provide early warning of a developing fire. Such a system, however, does not assure protection against property damage or loss of life resulting from a fire.

An emergency communication system—typically made up of an automatic fire alarm system (as described above) and a life safety communication system that may include an autonomous control unit (ACU), local operating console (LOC), voice communication, and other various interoperable communication methods—can broadcast a mass notification message. Such a system, however, does not assure protection against property damage or loss of life resulting from a fire or life safety event.

The Manufacturer recommends that smoke and/or heat detectors be located throughout a protected premises following the recommendations of the current edition of the National Fire Protection Association Standard 72 (NFPA 72), manufacturer's recommendations, State and local codes, and the recommendations contained in the Guide for Proper Use of System Smoke Detectors, which is made available at no charge to all installing dealers. This document can be found at <http://www.systemsensor.com/appguides/>. A study by the Federal Emergency Management Agency (an agency of the United States government) indicated that smoke detectors may not go off in as many as 35% of all fires. While fire alarm systems are designed to provide early warning against fire, they do not guarantee warning or protection against fire. A fire alarm system may not provide timely or adequate warning, or simply may not function, for a variety of reasons:

Smoke detectors may not sense fire where smoke cannot reach the detectors such as in chimneys, in or behind walls, on roofs, or on the other side of closed doors. Smoke detectors also may not sense a fire on another level or floor of a building. A second-floor detector, for example, may not sense a first-floor or basement fire.

Particles of combustion or "smoke" from a developing fire may not reach the sensing chambers of smoke detectors because:

- Barriers such as closed or partially closed doors, walls, chimneys, even wet or humid areas may inhibit particle or smoke flow.
- Smoke particles may become "cold," stratify, and not reach the ceiling or upper walls where detectors are located.
- Smoke particles may be blown away from detectors by air outlets, such as air conditioning vents.
- Smoke particles may be drawn into air returns before reaching the detector.

The amount of "smoke" present may be insufficient to alarm smoke detectors. Smoke detectors are designed to alarm at various levels of smoke density. If such density levels are not created by a developing fire at the location of detectors, the detectors will not go into alarm.

Smoke detectors, even when working properly, have sensing limitations. Detectors that have photoelectronic sensing chambers tend to detect smoldering fires better than flaming fires, which have little visible smoke. Detectors that have ionizing-type sensing chambers tend to detect fast-flaming fires better than smoldering fires.

Because fires develop in different ways and are often unpredictable in their growth, neither type of detector is necessarily best and a given type of detector may not provide adequate warning of a fire.

Smoke detectors cannot be expected to provide adequate warning of fires caused by arson, children playing with matches (especially in bedrooms), smoking in bed, and violent explosions (caused by escaping gas, improper storage of flammable materials, etc.).

Heat detectors do not sense particles of combustion and alarm only when heat on their sensors increases at a predetermined rate or reaches a predetermined level. Rate-of-rise heat detectors may be subject to reduced sensitivity over time. For this reason, the rate-of-rise feature of each detector should be tested at least once per year by a qualified fire protection specialist. Heat detectors are designed to protect property, not life.

IMPORTANT! Smoke detectors must be installed in the same room as the control panel and in rooms used by the system for the connection of alarm transmission wiring, communications, signaling, and/or power. If detectors are not so located, a developing fire may damage the alarm system, compromising its ability to report a fire.

Audible warning devices such as bells, horns, strobes, speakers and displays may not alert people if these devices are located on the other side of closed or partly open doors or are located on another floor of a building. Any warning device may fail to alert people with a disability or those who have recently consumed drugs, alcohol, or medication. Please note that:

- An emergency communication system may take priority over a fire alarm system in the event of a life safety emergency.
- Voice messaging systems must be designed to meet intelligibility requirements as defined by NFPA, local codes, and Authorities Having Jurisdiction (AHJ).
- Language and instructional requirements must be clearly disseminated on any local displays.
- Strobes can, under certain circumstances, cause seizures in people with conditions such as epilepsy.
- Studies have shown that certain people, even when they hear a fire alarm signal, do not respond to or comprehend the meaning of the signal. Audible devices, such as horns and bells, can have different tonal patterns and frequencies. It is the property owner's responsibility to conduct fire drills and other training exercises to make people aware of fire alarm signals and instruct them on the proper reaction to alarm signals.
- In rare instances, the sounding of a warning device can cause temporary or permanent hearing loss.

A life safety system will not operate without any electrical power. If AC power fails, the system will operate from standby batteries only for a specified time and only if the batteries have been properly maintained and replaced regularly.

Equipment used in the system may not be technically compatible with the control panel. It is essential to use only equipment listed for service with your control panel.

Telephone lines needed to transmit alarm signals from a premises to a central monitoring station may be out of service or temporarily disabled. For added protection against telephone line failure, backup radio transmission systems are recommended.

The most common cause of life safety system malfunction is inadequate maintenance. To keep the entire life safety system in excellent working order, ongoing maintenance is required per the manufacturer's recommendations, and UL and NFPA standards. At a minimum, the requirements of NFPA 72 shall be followed. Environments with large amounts of dust, dirt, or high air velocity require more frequent maintenance. A maintenance agreement should be arranged through the local manufacturer's representative. Maintenance should be scheduled as required by National and/or local fire codes and should be performed by authorized professional life safety system installers only. Adequate written records of all inspections should be kept.

Limit-D2-2016

Installation Precautions

Adherence to the following will aid in problem-free installation with long-term reliability:

WARNING - Several different sources of power can be connected to the fire alarm control panel. Disconnect all sources of power before servicing. Control unit and associated equipment may be damaged by removing and/or inserting cards, modules, or interconnecting cables while the unit is energized. Do not attempt to install, service, or operate this unit until manuals are read and understood.

CAUTION - System Re-acceptance Test after Software

Changes: To ensure proper system operation, this product must be tested in accordance with NFPA 72 after any programming operation or change in site-specific software. Re-acceptance testing is required after any change, addition or deletion of system components, or after any modification, repair or adjustment to system hardware or wiring. All components, circuits, system operations, or software functions known to be affected by a change must be 100% tested. In addition, to ensure that other operations are not inadvertently affected, at least 10% of initiating devices that are not directly affected by the change, up to a maximum of 50 devices, must also be tested and proper system operation verified.

This system meets NFPA requirements for operation at 0-49° C/ 32-120° F and at a relative humidity . However, the useful life of the system's standby batteries and the electronic components may be adversely affected by extreme temperature ranges and humidity. Therefore, it is recommended that this system and its peripherals be installed in an environment with a normal room temperature of 15-27° C/60-80° F.

Verify that wire sizes are adequate for all initiating and indicating device loops. Most devices cannot tolerate more than a 10% I.R. drop from the specified device voltage.

Like all solid state electronic devices, this system may operate erratically or can be damaged when subjected to lightning induced transients. Although no system is completely immune from lightning transients and interference, proper grounding will reduce susceptibility. Overhead or outside aerial wiring is not recommended, due to an increased susceptibility to nearby lightning strikes. Consult with the Technical Services Department if any problems are anticipated or encountered.

Disconnect AC power and batteries prior to removing or inserting circuit boards. Failure to do so can damage circuits.

Remove all electronic assemblies prior to any drilling, filing, reaming, or punching of the enclosure. When possible, make all cable entries from the sides or rear. Before making modifications, verify that they will not interfere with battery, transformer, or printed circuit board location.

Do not tighten screw terminals more than 9 in-lbs. Over-tightening may damage threads, resulting in reduced terminal contact pressure and difficulty with screw terminal removal.

This system contains static-sensitive components. Always ground yourself with a proper wrist strap before handling any circuits so that static charges are removed from the body. Use static suppressive packaging to protect electronic assemblies removed from the unit.

Follow the instructions in the installation, operating, and programming manuals. These instructions must be followed to avoid damage to the control panel and associated equipment. FACP operation and reliability depend upon proper installation.

Precau-D1-9-2005

FCC Warning

WARNING: This equipment generates, uses, and can radiate radio frequency energy and if not installed and used in accordance with the instruction manual may cause interference to radio communications. It has been tested and found to comply with the limits for class A computing devices pursuant to Subpart B of Part 15 of FCC Rules, which is designed to provide reasonable protection against such interference when devices are operated in a commercial environment. Operation of this equipment in a residential area is likely to cause interference, in which case the user will be required to correct the interference at his or her own expense.

Canadian Requirements

This digital apparatus does not exceed the Class A limits for radiation noise emissions from digital apparatus set out in the Radio Interference Regulations of the Canadian Department of Communications.

Le présent appareil numérique n'émet pas de bruits radioélectriques dépassant les limites applicables aux appareils numériques de la classe A prescrites dans le Règlement sur le brouillage radioélectrique édicté par le ministère des Communications du Canada.

HARSH™, NIS™, and NOTI•FIRE•NET™ are all trademarks; and Acclimate® Plus™, eVance®, FlashScan®, FAAST Fire Alarm Aspiration Sensing Technology®, Honeywell®, Intelligent FAAST®, NOTIFIER®, ONYX®, ONYXWorks®, SWIFT®, VeriFire®, and VIEW® are all registered trademarks of Honeywell International Inc. Microsoft® and Windows® are registered trademarks of the Microsoft Corporation. Chrome™ and Google™ are trademarks of Google Inc. Firefox® is a registered trademark of The Mozilla Foundation.

©2018 by Honeywell International Inc. All rights reserved. Unauthorized use of this document is strictly prohibited.

Software Downloads

In order to supply the latest features and functionality in fire alarm and life safety technology to our customers, we make frequent upgrades to the embedded software in our products. To ensure that you are installing and programming the latest features, we strongly recommend that you download the most current version of software for each product prior to commissioning any system. Contact Technical Support with any questions about software and the appropriate version for a specific application.

Documentation Feedback

Your feedback helps us keep our documentation up-to-date and accurate. If you have any comments or suggestions about our online Help or printed manuals, you can email us.

Please include the following information:

- Product name and version number (if applicable)
- Printed manual or online Help
- Topic Title (for online Help)
- Page number (for printed manual)
- Brief description of content you think should be improved or corrected
- Your suggestion for how to correct/improve documentation

Send email messages to:

FireSystems.TechPubs@honeywell.com

Please note this email address is for documentation feedback only. If you have any technical issues, please contact Technical Services.

Table of Contents

Section 1: Product Description	12
1.1: Features and Options	12
1.2: Specifications	13
1.3: Controls and Indicators	14
1.4: Components	15
1.4.1: Intelligent Addressable Detectors	16
1.4.2: Intelligent Addressable Modules	16
1.4.3: Addressable Device Accessories	16
End-of-Line Resistor Assembly	16
Power Supervision Relay	16
EOL-C(R/W) Mounting Plate	16
1.5: Optional Modules	16
1.6: Accessories	16
1.6.1: FS-Tools Programming Utility	16
1.6.2: Dress Panel	17
1.6.3: Trim Ring	17
1.6.4: Battery Box	17
BB-26	17
NFS-LBB	17
1.6.5: Battery Charger	17
CHG-75 Battery Charger	17
CHG-120 Battery Charger	17
1.6.6: FWSG Wireless Gateway	17
1.6.7: ANN-BUS Annunciators/Modules	18
Guidelines	18
N-ANN-80 and N-ANN-100 Remote Fire Annunciators	18
N-ANN-S/PG Serial/Parallel Interface Module	18
N-ANN-I/O LED Driver Module	18
N-ANN-LED Annunciator Module	18
N-ANN-RLY Annunciator Module	18
1.7: Getting Started	19
1.8: Telephone Requirements and Warnings	19
1.8.1: Telephone Circuitry	19
1.8.2: Telephone Company Rights and Warnings	19
Section 2: Installation	20
2.1: Mounting the Backbox	20
2.2: Power	23
2.2.1: AC Power and Earth Ground Connection	23
2.2.2: Battery Power	23
2.2.3: Special Application DC Power Output Connection	24
2.3: Relays	24
2.4: Notification Appliance Circuits	24
2.4.1: Class B NAC Wiring	25
2.4.2: Class A NAC Wiring	25
2.5: Remote Synchronization Output	26
2.6: UL Power-limited Wiring Requirements	27
2.7: IPOTS-COM Communicator	28
Wiring	28
Dip Switches	28
2.8: Optional Module Installation	29
2.8.1: CELL-MOD/CELL-CAB-N	29
Installation	29
Wiring	29
2.8.2: 4XTM Transmitter Module Installation	29
2.8.3: ANN-BUS Annunciators/Modules	31
ANN-BUS Wiring	31
ANN-BUS Device Addressing	34
N-ANN-80 Remote Fire Annunciator	34
N-ANN-100 Remote Fire Annunciator	36
N-ANN-S/PG Serial/Parallel Interface Module	37

N-ANN-I/O LED Driver Module	39
N-ANN-LED Annunciator Module	41
N-ANN-RLY Annunciator Module	43
2.8.4: Printer	44
Printer Configuration	44
2.8.5: FWSG Wireless Gateway	45
Section 3: Programming	46
3.1: Programming Data Entry	46
3.2: User Programming	47
3.3: Initial Power-up	48
3.4: Programming Screens Description	48
3.5: Programming and Passwords	48
3.6: Master Programming Level	49
3.6.1: Autoprogram	49
3.6.2: Point Program	50
Detector Programming	50
Module Programming	56
3.6.3: Zone Setup	65
Enable	65
Disable	65
Special Purpose Zone	65
Zones Installed	66
Zones Enabled	66
Zones Disabled	66
Zone Type	67
Zones Available	67
3.6.4: Loop Setup	67
Class	68
Loop Protocol	68
Device Addressing	68
3.6.5: System Setup	68
Function Keys	69
Banner	69
Time-Date	70
Timers	71
NACS (Notification Appliance Circuits)	72
Relays	75
Canadian Option	75
Waterflow Silenceable	76
Auxiliary Power	76
Trouble Reminder	76
Language	76
Charger Enable	76
4XTM Supervision	76
Remote Sync Enable	76
3.6.6: History	77
View Events	77
Erase History	77
3.6.7: Communicator	77
Communicator Installed	77
POTS Settings	78
IP Settings	79
Primary and Secondary Communication Paths	80
Trouble Report Limit (Dialer Runaway Prevention)	82
Report Style	83
Event Codes	83
3.6.8: Annunciators	86
ANN-BUS Setup	86
ANN-BUS Options	93
3.6.9: Password Change	95
Invalid Password	95

3.6.10: Clear Program	96
3.6.11: Program Check	96
3.7: Maintenance Programming Level.....	97
3.7.1: Disable Point.....	97
3.7.2: History	97
3.7.3: Program Check	98
3.7.4: Walktest	99
3.7.5: System.....	99
3.7.6: Zone Setup.....	100
Section 4: Operating Instructions.....	102
4.1: Panel Control Buttons.....	102
4.1.1: Acknowledge	102
4.1.2: Alarm Silence	102
4.1.3: Drill/Hold 2 Sec.....	102
4.1.4: Reset	102
4.1.5: Function Keys F1-F4	102
4.2: LED Indicators.....	102
4.3: Normal Operation	103
4.4: Trouble Operation.....	103
4.5: Alarm Operation	104
4.6: CO Alarm Operation.....	105
4.7: Supervisory Operation	105
4.8: Process Monitor Operation	106
4.9: Hazard/Tornado Condition Operation	106
4.10: Medical Alert Condition Operation	106
4.11: NAC Operation	107
4.12: Programmed Zone Operation	107
4.13: Disable/Enable Operation.....	107
4.14: Waterflow Circuits Operation	107
4.15: Detector Functions.....	107
4.16: Time Functions: Real-Time Clock.....	107
4.17: Synchronized NAC Operation.....	107
4.18: Coded Operation.....	108
4.19: Presignal	108
4.20: Positive Alarm Sequence	108
4.21: Special System Timers.....	109
4.21.1: Silence Inhibit Timer	109
4.21.2: Autosilence Timer	109
4.21.3: Trouble Reminder.....	109
4.21.4: Waterflow Retard Timer.....	109
4.21.5: Alarm Verification (None or One Minute).....	109
4.21.6: Control Module Delay Timer	109
4.22: Walktest.....	109
4.23: Read Status	110
4.23.1: System Point	110
4.23.2: Zones.....	111
4.23.3: Trouble Reminder.....	111
4.23.4: Timers	112
4.23.5: NACs	112
4.23.6: Relays	112
4.23.7: Program Check	112
4.23.8: History	112
4.23.9: Annunciators.....	113
4.23.10: Communicator	113
4.23.11: Print.....	114
Chamber Value	115
Drift Compensation.....	115
Maintenance Alert.....	115
4.23.12: Time-Date	116
4.23.13: Battery Charger.....	116
4.23.14: 4XTM Supervision	116

4.23.15: Remote Sync	116
Section 5: Central Station Communications - POTS Transmission	117
5.1: Transmittal Priorities	117
Section 6: FS-Tools Upload/Download.....	119
6.1: FS-Tools Up/Download	119
6.2: Transferring a Program	119
6.2.1: Security Features	120
Secret Code Verification.....	120
Time-out at Control Panel.....	120
Error Checking.....	120
Central Station Data Protection	120
Section 7: USB Upload/Download	121
7.1: USB Upload/Download	121
Section 8: Firmware Upgrade.....	123
8.1: Firmware Upgrade	123
Section 9: Power Supply Calculations	125
9.1: Overview.....	125
9.2: Calculating the AC Branch Circuit	125
9.3: Calculating the System Current Load.....	125
9.3.1: Overview.....	125
9.3.2: How to Calculate System Current Load	125
9.4: Calculating the Battery Size	127
9.4.1: NFPA Battery Requirements	127
9.4.2: Selecting and Locating Batteries	127
Appendix A: Software Zones.....	128
A.1: Correlations.....	128
Appendix B: Default Programming.....	133
Appendix C: NFPA Standard-Specific Requirements	134
C.1: MBT-1 Municipal Box Trip - Silenceable	137
Appendix D: Wire Requirements.....	138
D.1: NAC Wiring	139
Appendix E: HVAC Control.....	140
E.1: Control Module Operation	140
E.1.1: HVAC SHUTDOWN.....	140
E.2: Monitor Module Operation	141
E.2.1: HVAC RESTART.....	141
E.2.2: HVAC OVERRIDE.....	141
Appendix F: Ademco Contact ID Format Event Code Descriptions	142
F.1: Transmission Format Between DACT and Receiver.....	142
F.2: Ademco Contact ID Typical Printout.....	142
Appendix G: NFPA Requirements	147
Appendix H: Open/Short/Ground Trip Values	148
Index	149
Slide-in Labels	153
NFW-50X Fire Alarm Control Panel	
 Operating Instructions.....	155

It is imperative that the installer understand the requirements of the Authority Having Jurisdiction (AHJ) and be familiar with the standards set forth by the following regulatory agencies:

- Underwriters Laboratories
- National Fire Protection Association

Before proceeding, the installer should be familiar with the following documents.



NFPA Standards

- NFPA 72 National Fire Alarm Code
- NFPA 70 National Electrical Code
- NFPA 720 Carbon Monoxide Detection and Warning Equipment



Underwriters Laboratories Documents:

- UL 38 Manually Actuated Signaling Boxes
- UL 217 Smoke Detectors, Single and Multiple Station
- UL 228 Door Closers—Holders for Fire Protective Signaling Systems
- UL 268 Smoke Detectors for Fire Protective Signaling Systems
- UL 268A Smoke Detectors for Duct Applications
- UL 346 Waterflow Indicators for Fire Protective Signaling Systems
- UL 464 Audible Signaling Appliances
- UL 521 Heat Detectors for Fire Protective Signaling Systems
- UL 864 Standard for Control Units for Fire Protective Signaling Systems
- UL 1481 Power Supplies for Fire Protective Signaling Systems
- UL 1638 Visual Signaling Appliances
- UL 1971 Signaling Devices for Hearing Impaired
- UL 2017 General-Purpose Signaling Devices and Systems
- UL 2075 Standard for Gas and Vapor Detector and Sensors

Other:

- EIA-232E Serial Interface Standard
- EIA-485 Serial Interface Standard
- NEC Article 250 Grounding
- NEC Article 300 Wiring Methods
- NEC Article 760 Fire Protective Signaling Systems
- Applicable Local and State Building Codes
- Requirements of the Local Authority Having Jurisdiction (LAHJ)

NOTIFIER Documents:

- | | |
|--|---------------------------|
| NOTIFIER Device Compatibility | Document #15378 |
| FireWarden SLC Wiring Manual | Document #52304 |
| ONYX Series SLC Wiring Manual | Document #51253 |
| Notifier Wireless Gateway Manual | Document #LS10036-000NF-E |
| CHG-120 Battery Charger | Document #50641 |
| CHG-75 Battery Charger | Document #51315 |
| IPOTS-COM POTS/IP Communicator | Document #LS10184-000GE-E |
| CELL-CAB-N GSM Communicator | Document #LS10186-001NF-E |
| N-ANN-80 Product Installation Document | Document #52986 |
| N-ANN-100 Product Installation Document | Document #LS10205-001NF-E |
| N-ANN-(R)LED Product Installation Document | Document #53317 |
| N-ANN-I/O Product Installation Document | Document #151243 |
| N-ANN-RLY Product Installation Document | Document #53318 |
| N-ANN-S/PG Product Installation Document | Document #151424 |

This product has been certified to comply with the requirements in the Standard for Control Units and Accessories for Fire Alarm Systems, UL 864, 9th Edition. Operation of this product with products not tested for UL 864, 9th Edition has not been evaluated. Such operation requires the approval of the local Authority Having Jurisdiction (AHJ).

Basic System Connections

2 Programmable Relays & Fixed Trouble Relay

Non-supervised relay contacts
 Contact rating:
 2.0 amps @ 30 VDC (resistive)
 0.5 amps @ 30 VAC (resistive)
 Contacts shown below in normal condition (AC power with no alarm, trouble, or supervisory activity)
 AC Fail Safe Trouble relay switches to the NO position during trouble conditions and under loss of all power.
 (*Factory default relay programming)

Notification Appliance Circuits
 NAC #1 and #2 Class A or Class B (Supervised, Power-Limited) (Special application)
 2.5 amps max. per circuit
 ELRs, 4.7K, 1/2W (for Class B wiring)

Remote Synchronization Output
 Supervised, Power-Limited circuits
 24 VDC filtered (0.35 amp maximum), Requires a 4.7 Kohm End-of-Line Resistor

Special Applications

DC Power Outputs (24 VDC)
 Non-supervised, Power-Limited circuits
 Nonresettable Power suitable for powering annunciators; Resettable Power suitable for powering smoke detectors.
 24 VDC filtered, power-limited (1.0 amp maximum), Class A or Class B wiring possible. Supervision required for Class B wiring. Supervise with a power supervision relay EOLR-1

Primary ANN-BUS to Annunciators (power-limited, supervised)

SW2: 4XTM Supervisory Relay:
 Slide switch to the down position to enable the relay when the 4XTM is installed

To disable ground fault detection, slide SW1 to the left.

Important! Disabling Ground Fault Detection voids UL/NFPA Class identifications for circuits. Disable Ground Fault only with the approval of the AHJ (Authority Having Jurisdiction).

USB Port J20 for firmware updates, local programming using a personal computer and FS-Tools utility or a thumb drive

Battery
 24 VDC, supervised, nonpower-limited, 18 AH maximum

AC Power (Supervised, Nonpower-Limited)
 120 or 240 VAC, 50/60 Hz, 3.25 amps

CAUTION! HIGH VOLTAGE

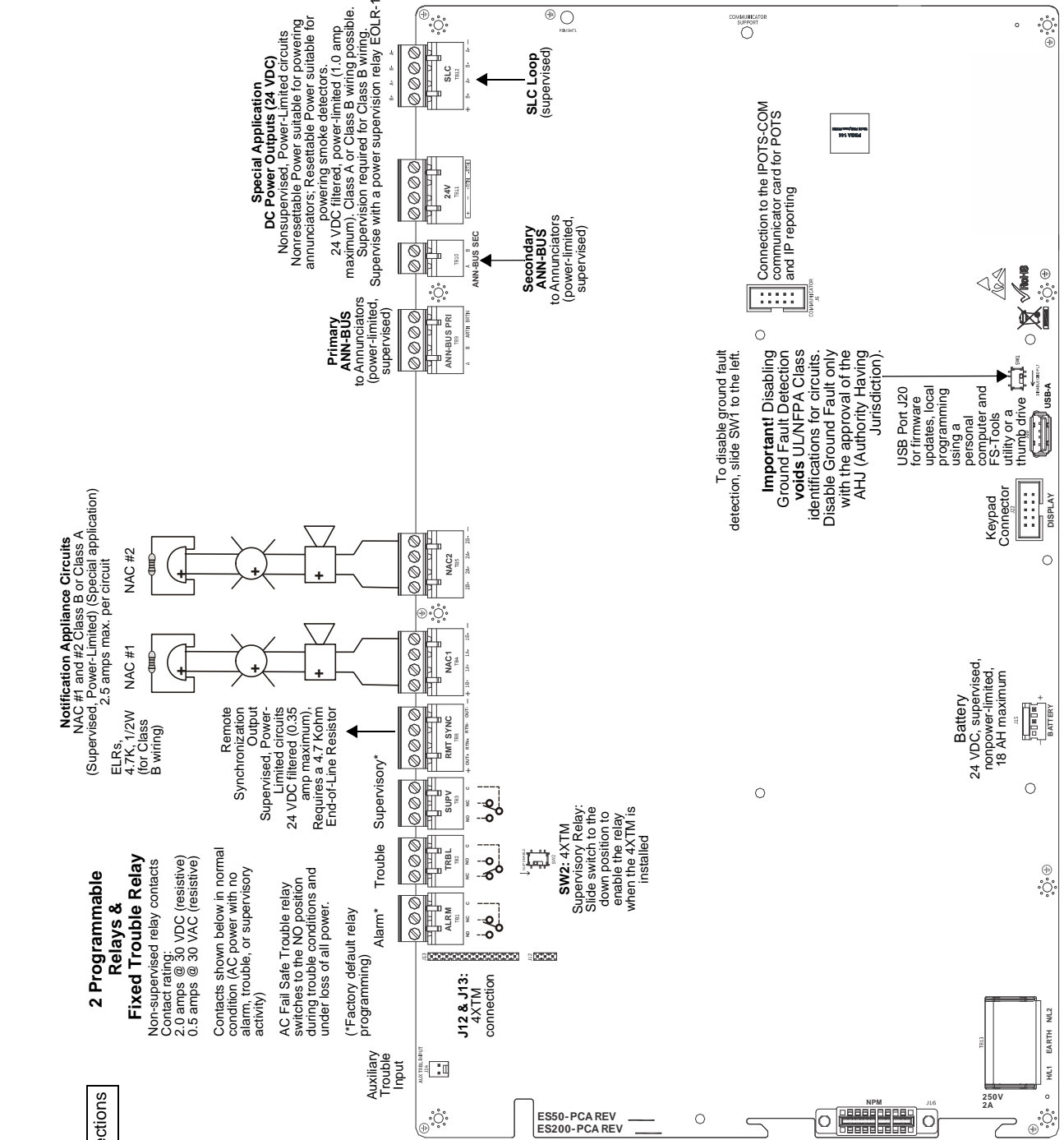

Peripheral Devices and Their Documents:

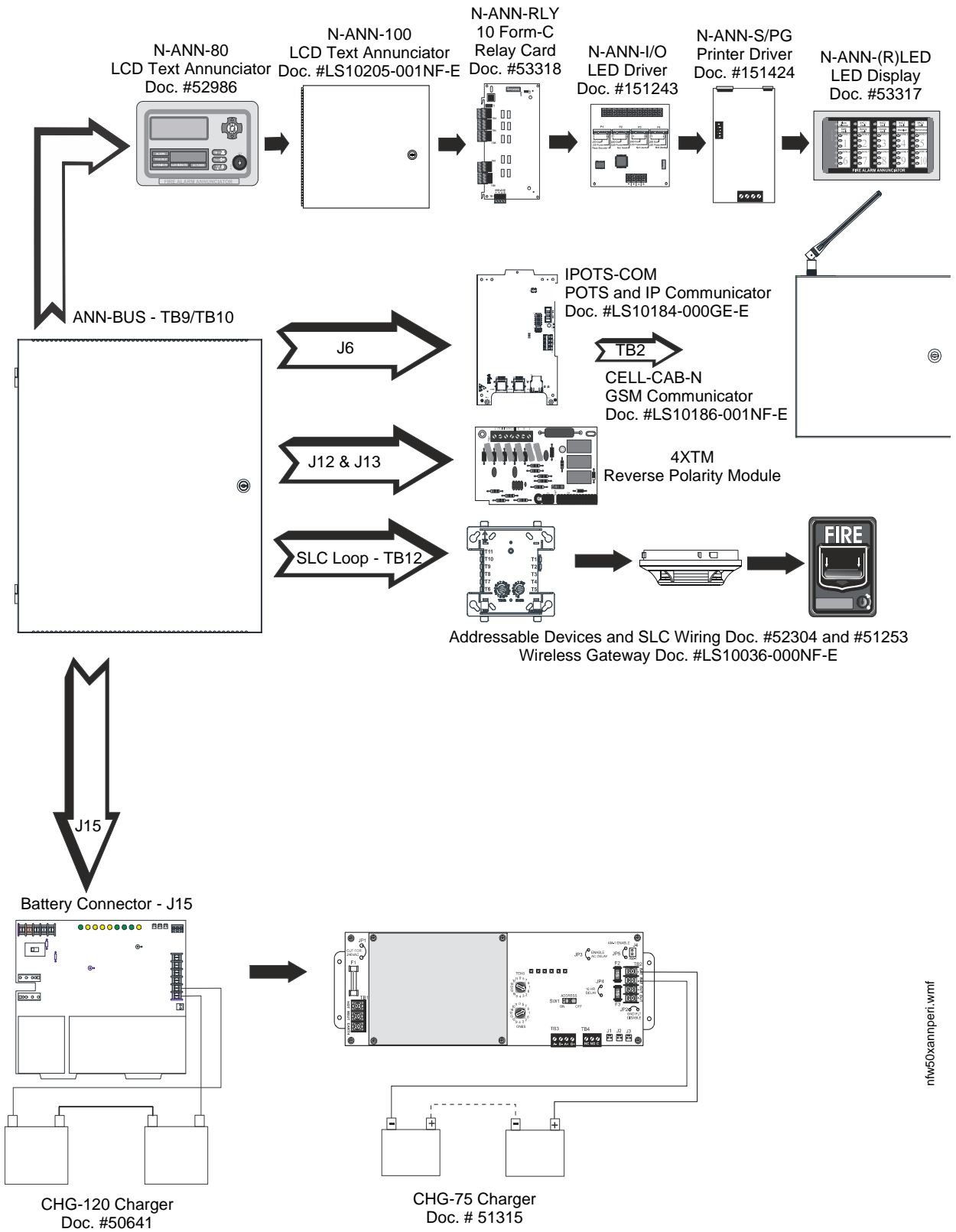

ntw50xannperi.wmf

Section 1: Product Description

The NOTIFIER NFW-50X is an addressable FACP (Fire Alarm Control Panel) with a pre-installed communicator card that is compact, cost effective, intelligent, and has an extensive list of powerful features which offers the latest in fire protection technology. The power supply and all electronics are housed in a metal cabinet, providing a complete fire control system for most applications. Optional modules, which plug into the main circuit board, are available for special functions. Available accessories include multi-technology central station communicators, LED, graphic, and LCD annunciators, reverse polarity/city box transmitter, local and remote upload/download software, and remote power expansion.

Inventory

When NFW-50X shipment is received, check that all parts have been included in shipment. The NFW-50X shipment consists of one of each of the following:

- ✓ main circuit board with display
- ✓ backbox with door
- ✓ plastic bag containing screws, cables, ELRs, terminal blocks, etc.

1.1 Features and Options

- Pre-installed IPOTS-COM Ethernet IP and POTS (Plain Old Telephone Service) Central Station Communicator
- Optional CELL-MOD or CELL-CAB-N GSM Central Station Communicator over AlarmNet
- FlashScan® polling protocol for faster SLC response time
- SLC operates up to 10,000 ft. (3,000 m) in LiteSpeed mode with twisted, unshielded wire (refer to “Wire Requirements” on page 138)
- Single addressable SLC loop which meets NFPA Class A, Class B, and Class X requirements
- 50 addressable device capacity (any combination of addressable detectors and addressable control/relay/monitor modules totaling 50)
- 50 software zones
- Two (2) Class B or two (2) Class A NAC (Notification Appliance Circuits) circuits - special application power
- 3.0 amps total 24 VDC output circuit current in alarm condition
- Four programmable function keys for ease of maintenance
- Two programmable relay outputs and one fixed trouble relay
- Synchronization output for remote power supply applications (special application)
- Built-in Programmer
- 80-character LCD display (backlit)
- Real-time clock/calendar with daylight savings time control
- History file with 1,000 event capacity
- Addressable sounder base compatibility
- Advanced fire technology features:
 - ✓ Automatic drift compensation
 - ✓ Maintenance alert
 - ✓ Detector sensitivity test capability (NFPA 72 compliant)
 - ✓ Automatic device type-code verification
 - ✓ Point trouble identification
- Waterflow selection per module point
- Alarm verification selection per detector point
- Walktest, silent or audible
- PAS (Positive Alarm Sequence) and Pre-signal per point (NFPA 72 compliant)
- Silence inhibit timer option per NAC
- Autosilence timer option per NAC
- Continuous, March Time, Temporal or California code for main circuit board NACs with two-stage capability
- Selectable strobe synchronization per NAC
- Remote Acknowledge, Alarm Silence, Reset and Drill via addressable modules or N-ANN-80/N-ANN-100 Remote annunciator
- Auto-program (learn mode) reduces installation time. Reports two devices set to the same address
- Password and key-protected nonvolatile memory
- User programmable password
- Fully programmable from local keypad
- Optional FS-Tools programming utility for local or remote Upload/Download of programming and data (available for download from www.notifier.com)
- Compatible with FireWarden’s and NOTIFIER’s addressable devices (refer to the FireWarden/ONYX SLC Wiring Manuals for a list of compatible addressable devices)
- Optional 4XTM module (conventional reverse polarity/city box transmitter)
- ANN-BUS for connection to following optional modules:
 - ✓ N-ANN-80 Remote Annunciator (UL applications only)
 - ✓ N-ANN-100 (FM only)
 - ✓ N-ANN-I/O LED Driver
 - ✓ N-ANN-S/PG Printer Module

- ✓ N-ANN-RLY Form-C Relay Module
- ✓ N-ANN-LED Annunciator Module annunciates alarm, trouble and supervisory (required for emergency signaling)
- ✓ N-ANN-RLED Annunciator Module annunciates alarms only

1.2 Specifications

Refer to Illustration on page 10 for terminal locations and connections.

AC Power - TB13

Operates in either 120 or 240 VAC, 50/60 Hz, 3.25 amps, auto-sensing. No switch or jumper required.

Wire size: minimum 14 AWG (2.00 mm²) with 600 V insulation

Battery (Sealed Lead Acid Only) - J15

Maximum Charging Circuit: Normal Flat Charge – 27.6 VDC @ 1.5 amps

Maximum Battery Charger Capacity: 18 Amp Hour (FACP cabinet holds maximum of two 18 Amp Hour batteries. The BB-26 Battery Box holds two 26 Amp Hour batteries and the CHG-75. For greater than 26 Amp Hour up to 120 Amp Hour batteries, use the CHG-75 or CHG-120 Battery Charger and NFS-LBB Battery Box).

Minimum Battery Size: 7 Amp Hour

Note: Refer to the programming section to disable the FACP battery charger when using an external battery charger.

Communication Loop - TB12

24 VDC nominal, 27.6 VDC maximum

Maximum length - refer to “Wire Requirements” on page 138)

Maximum loop current is 200 mA (short circuit) or 100 mA (normal)

Maximum loop resistance is 40 ohms

Supervised and power-limited circuit

Refer to *SLC Wiring manuals* for wiring information

Notification Appliance Circuits/Special Application (Auxiliary) Power - TB4 & TB5

Two (2) Class B NAC circuits or two (2) Class A circuits

Special Application, filtered power

Power-limited circuitry

NAC wiring requirements refer to “NAC Wiring” on page 139

Nominal operating voltage: 24 VDC

Current-limit: fuseless, electronic, power-limited circuitry

Maximum signaling current per circuit: 2.5 amps special application, 250 mA regulated for NACs (see Figure 1.1 on page 14)

Maximum signaling current per circuit: 1.0 amp for auxiliary power

End-of-Line Resistor: 4.7 k Ω , ½ watt (P/N 71252 UL listed) required for each circuit; system capable of 1.9 k Ω - 22 k Ω ELR range.

Refer to the *Device Compatibility Document* for listed compatible devices

A circuit programmed for auxiliary power does not support notification appliances.

Two Programmable Relays and One Fixed Trouble Relay - TB1, TB2, & TB3

Contact rating: 2.0 amps @ 30 VDC (resistive), 0.5 amps @ 30 VAC (resistive)

Form-C relays

Refer to Figure 2.6 on page 24 for information on power-limited relay circuit wiring

Remote Sync Output - TB8

Remote power supply synchronization output

24 VDC nominal special application power

Maximum current is 350 mA

End-of-Line Resistor: 4.7K Ω

Output linked to NAC 1 control

Supervised and power-limited circuit

Programmable Class A or Class B wiring

Secondary ANN-BUS - TB10

ANN-BUS annunciator connector, Terminal 1 (+/A) and Terminal 2 (-/B)

Annunciators require non-resettable power

Primary ANN-BUS - TB9

Class A or Class B wiring

ANN-BUS annunciator connector, Terminal 1 (+/A) and Terminal 2 (-/B)

Class A wiring uses Terminal 3 (+/A Return) and Terminal 4 (-/B Return)

Annunciators require non-resettable power

The following figure illustrates the maximum current that is possible for each major panel output circuit and the total current available from the FACP.

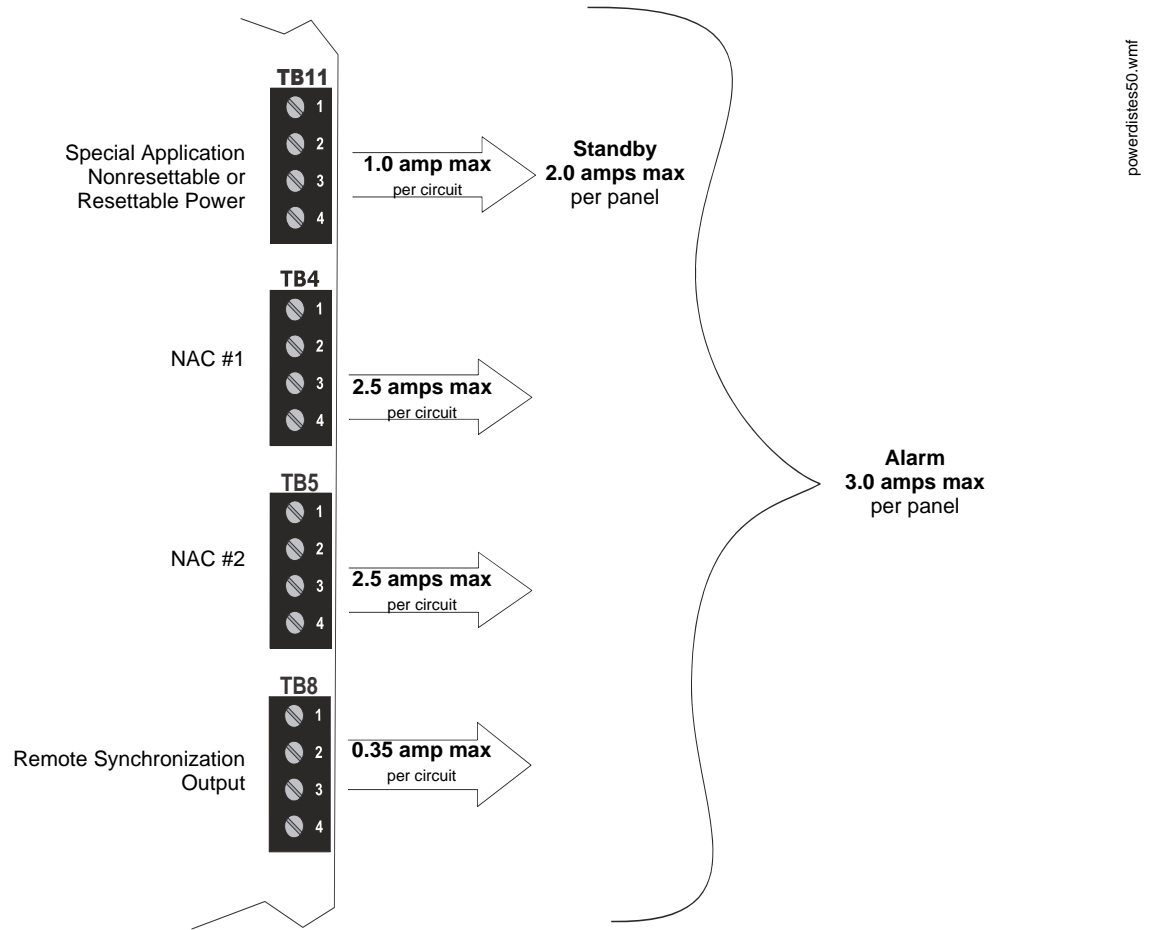

Refer to the battery calculations section for additional information.

Figure 1.1 Current Availability

1.3 Controls and Indicators

LCD Display

The FACP uses an 80-character (4 lines X 20 characters) high viewing angle LCD display. The display includes a long life LED backlight that remains illuminated. If AC power is lost and the system is not in alarm, the LED backlight will turn off to conserve batteries.

Key Panel

Mounted on the main circuit board, the key panel includes a window for the LCD display and LED indicators as listed below. The key panel, which is visible with the cabinet door closed, has 30 keys, including a 16 key alphanumeric pad similar to a telephone keypad.



LED Indicators

LED indicators are provided to annunciate the following conditions:

- Fire Alarm (red)
- CO Alarm (red)
- AC Power (green)
- Supervisory (yellow)
- Trouble (yellow)
- Ground fault (yellow)
- Battery fault (yellow)
- Disabled (yellow)
- Maintenance (yellow)
- Communication (yellow)
- Alarm Silenced (yellow)
- F1-F4 Function Keys (yellow)

Function keys:

- Acknowledge
- Alarm Silence
- Drill
- Reset (lamp test)
- four (4) programmable function keys

Service/program keys:

- Keys labeled 1 to 9
- * key
- # key
- 0 (recall) key
- First Event and scroll keys
- Last Event and scroll keys
- Clear key
- Escape key
- Two cursor keys (left and right)
- Menu/Enter key

Local Piezo Sounder

A piezo sounder provides separate and distinct pulse rates for alarm, trouble and supervisory conditions.

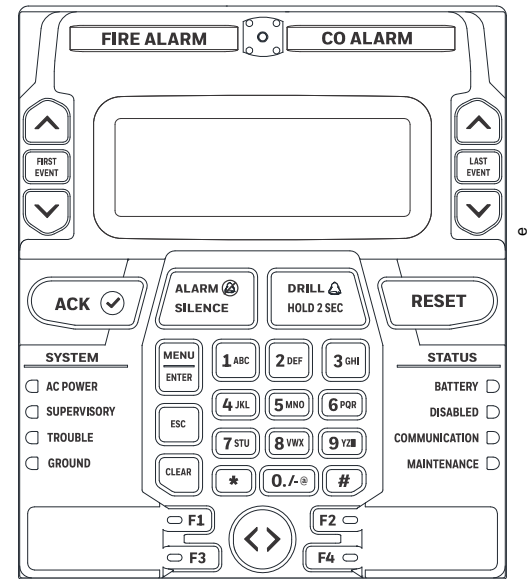

Figure 1.2 Membrane/Display Panel

1.4 Components

Main Circuit Board

The main circuit board contains the system's CPU, power supply, other primary components and wiring interface connectors. The 4XTM option module plugs in and is mounted to the main circuit board.

IPOTS-COM Communicator Card

The pre-installed IP/POTS communicator card transmits system status (alarms, troubles, AC loss, etc.) to a Central Station via the public switched telephone network. It also allows remote programming or interrogation of the control panel using the FS-Tools Upload/Download utility and a hard-wired ethernet IP connection. Any personal computer with Windows[®] 7 or greater, 32 or 64 bit, and FS-Tools software may serve as a Service Terminal. This allows download of the entire program or upload of the entire program, history file, walktest data, current status and system voltages. See Section 6 on page 119 for more information.

The IPOTS-COM digital communicator provides the following POTS functions:

- Line Seizure: takes control of the phone lines disconnecting any premises phones
- Off/On Hook: performs on and off-hook status to the phone lines
- Listen for dial tone: 440 Hz tone typical in most networks
- Dialing the Central Station(s) number: default is Touch-Tone[®], programmable to rotary
- For tone burst or touchtone type formats: discern proper *Ack* and *Kissoff* tone(s). The frequency and time duration of the tone(s) varies with the transmission format. The control panel will adjust accordingly.
- Communicate in the following formats:
 - ✓ Ademco Contact ID
 - ✓ SIA DCS 8
 - ✓ SIA DCS 20

Cabinet

The NFW-50X backbox provides space for two batteries (up to 18 Amp Hour). Ample knockouts are provided for system wiring. Also available is an optional dress panel (DP-ES-R or DP-ES-B), which mounts to the inside of the cabinet.

Batteries

The NFW-50X cabinet provides space for two batteries (up to 18 Amp Hour). Batteries larger than 18 Amp Hour require an external charger such as the CHG-75 or CHG-120 and a UL listed battery box such as the BB-26 or NFS-LBB. Batteries must be ordered separately.

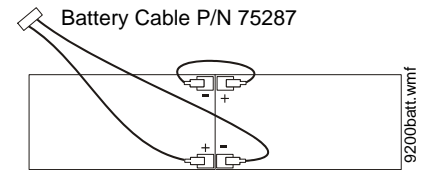

1.4.1 Intelligent Addressable Detectors

Intelligent, addressable detectors provide information to the control panel on an SLC Signaling Line Circuit (refer to the FireWarden/ONYX SLC Wiring Manuals for detailed information on device installation, wiring and operation). This allows the control panel to continually process the information to determine the status (alarm, trouble, maintenance or normal) of each detector. Each detector responds to an SLC address that is set in the detector head using built-in rotary decimal switches. The maximum address cannot exceed address 50. Note that a blinking LED on an intelligent detector indicates communication between the detector and the control panel.

These devices can operate in CLIP mode (Classic Loop Interface Protocol) or FlashScan mode to provide a quicker response. Refer to the FireWarden/ONYX SLC Wiring Manuals for a list of compatible addressable detectors or the Device Compatibility Document for conventional detectors.

1.4.2 Intelligent Addressable Modules

Control Modules and Monitor Modules provide an interface between the control panel and conventional notification and initiating devices. Each module can be set to respond to an address with built-in rotary switches. The maximum address cannot exceed address 50. Note that a blinking LED on an addressable module indicates communication between the module and the control panel.

These devices can operate in CLIP mode (Classic Loop Interface Protocol) or FlashScan mode to provide a quicker response. Refer to the *FireWarden/ONYX SLC Wiring Manuals* for a list of compatible addressable modules. Refer to the *Device Compatibility Document* for a list of approved conventional notification and initiating devices.

1.4.3 Addressable Device Accessories

End-of-Line Resistor Assembly

The End-of-Line resistors are included with each module. Refer to the specific module documentation for specific information.

Power Supervision Relay

The UL listed End-of-Line power supervision relay is used to supervise the power to 4-wire smoke detectors and notification appliances.

EOL-C(R/W) Mounting Plate

The EOL-CR (red) and EOL-CW (white) are single End-of-Line resistor plates. An ELR, which is supplied with each module and fire alarm control panel, is mounted to the EOL-C(R/W) plate. Resistors mounted to the plate can be used for the supervision of a monitor and control module circuit.

1.5 Optional Modules

The NFW-50X main circuit board includes option module connectors for the following modules:

CELL-MOD/CELL-CAB-N

Optional GSM communicator card for central station reporting. It mounts in its own plastic or metal enclosure. Use of the CELL-MOD/CELL-CAB-N requires the IPOTS-COM communicator. Connections are made from the CELL-MOD/CELL-CAB to the IPOTS-COM.

4XTM Transmitter Module

The 4XTM provides a supervised output for local energy municipal box transmitter, alarm and trouble reverse polarity. It includes a disable switch and disable trouble LED. A jumper on the module is used to select an option which allows the reverse polarity circuit to open with a system trouble condition if no alarm condition exists. The module plugs into connectors J5 and J6 which are located near the right edge the main circuit board. When the 4XTM module is installed, Jumper JP3, on the main circuit board, must be cut to allow supervision of the module.

1.6 Accessories

1.6.1 FS-Tools Programming Utility

The FS-Tools Programming Utility can be used to locally or remotely program the FACP from most Windows® compatible computers (PC), running Windows 7 or newer, 32 or 64 bit. The FACP program files can also be created and stored on the PC for future download to the control panel. FS-Tools can be downloaded from www.notifier.com. A standard USB cable with male-A to male-A connectors, which must be purchased separately, is required for local connection of the PC to the USB port J20 on the FACP main circuit board. Remote programming requires that the PC have a GSM or ethernet connection.

FS-Tools also provides the ability to create panel program files on a USB flash drive. The drive can then be plugged into USB port J20 on the FACP main circuit board.

Important: Remote modification of FACP programming requires that the panel be enabled for remote download (refer to “FS-Tools Upload/Download” on page 119). Remote interrogation of panel programming, history logs, detector status, etc., is possible without enabling the remote download option.

1.6.2 Dress Panel

An optional dress panel, DP-ES-R or DP-ES-B is available for the NFW-50X. The dress panel restricts access to the system wiring while allowing access to the key panel. A ground strap must be connected between the stud on the inside of the dress panel and the ground stud in the backbox. The dress panel mounts to the backbox with two (2) #4 screws and washers or two (2) #6 screws.

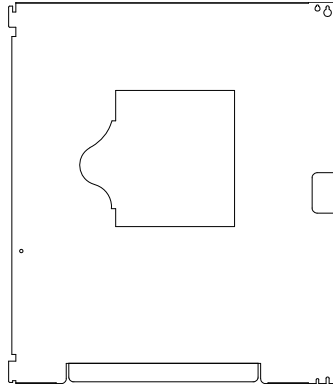

1.6.3 Trim Ring

Optional Trim Rings (P/N TR-CE-B black, TR-CE red) are available for the FACP backbox. The Trim Rings add 1.5” of wall coverage around the backbox, concealing hardware and providing a finished appearance for a semi-flush mounted panel.

1.6.4 Battery Box

BB-26

The BB-26 battery box may be used to house up to two 26 AH batteries and the CHG-75 Battery Charger.

NFS-LBB

The NFS-LBB battery box may be used to house two 26 AH batteries, two 60 AH batteries or one 100 AH battery. When the CHG-120 is mounted in the NFS-LBB, two 26 AH or one 60 AH battery may also be housed in the battery box.

1.6.5 Battery Charger

CHG-75 Battery Charger

The CHG-75 is capable of charging up to 75 AH lead-acid batteries with the NFW-50X FACP. The FACP battery charger must be disabled, by removing jumper JP5, when using the CHG-75. The charger and up to 26 AH batteries can be housed in the BB-26 battery box. Larger batteries and the charger can be housed in the NFS-LBB battery box which can be mounted up to 20 feet away from the control panel. Refer to the *CHG-75 Manual* for additional information.

CHG-120 Battery Charger

The CHG-120 is capable of charging up to 120 AH lead-acid batteries with the NFW-50X FACP. The FACP battery charger must be disabled, by removing jumper JP5, when using the CHG-120. The batteries and charger can be housed in the NFS-LBB battery box which can be mounted up to 20 feet away from the control panel. Note that when using the NFS-LBB for housing the charger and batteries greater than 26AH, multiple NFS-LBBs are required. Refer to the *CHG-120 Manual* for additional information.

1.6.6 FWSG Wireless Gateway

The FWSG Wireless Gateway acts as a bridge between a group of wireless fire devices and a FlashScan SLC loop on the NFW-50X. It is powered by the SLC loop or by a regulated, external 24VDC UL-listed power supply evaluated for life safety. Available wireless devices include a photo detector, Acclimate detector, a fixed-temperature heat detector, a rate-of-rise heat detector, a monitor module, and a relay module. For details about wireless devices, system setup, and operation, see the *SWIFT® Smart Wireless Integrated Fire Technology Instruction Manual #LS10036-000NF-E*.



NOTE: The FWSG, as part of the wireless network, has been tested for compliance with the Federal Communications Commission (FCC) requirements of the United States Government. It has not been evaluated for use outside the USA. Use of this system outside the USA is subject to local laws and rules to which this product may not conform. It is the sole responsibility of the user to determine if this product may be legally used outside the USA.

1.6.7 ANN-BUS Annunciators/Modules



WARNING: RISK OF ELECTRICAL SHOCK AND EQUIPMENT DAMAGE

DISCONNECT ALL SOURCES OF POWER (AC AND DC) BEFORE INSTALLING OR REMOVING ANY MODULES OR WIRING.

Guidelines

- A variety of optional annunciation devices can be connected to an ANN-BUS communication circuit. ANN Series devices can be connected to the primary communication circuit (EIA-485) terminals on TB9. A secondary communication circuit for these devices is available at TB8. Each ANN-BUS communication circuit supports up to eight (8) annunciators. Compatible devices include the following:
 - N-ANN-80 LCD Annunciator (UL applications only)
 - N-ANN-100 LCD Annunciator (FM applications only)
 - N-ANN-S/PG Serial/Parallel Printer Interface Module
 - N-ANN-I/O LED Driver Module
 - N-ANN-LED Annunciator Module (alarm, trouble, supervisory LEDs)
 - N-ANN-RLED Annunciator Module (red alarm LEDs only)
 - N-ANN-RLY Relay Module (can be mounted in the supplied FACP chassis)
- When operating two ANN-BUS circuits, only one N-ANN-S/PG Printer module can be used in the system.
- The panel is capable of operating a primary ANN-BUS (TB9) and a secondary ANN-BUS (TB10) simultaneously.

N-ANN-80 and N-ANN-100 Remote Fire Annunciators

The N-ANN-80 and N-ANN-100 Annunciators are 80 character, backlit, LCD remote fire annunciators. They mimic the display on the control panel and will annunciate device type, point alarm, trouble or supervisory condition, zone assignment plus any custom alpha labels programmed into the FACP. The annunciators also provide system status LEDs to display AC Power, Alarm, Trouble, Supervisory and Alarm Silenced conditions. Additionally, the annunciators are capable of remotely performing critical system functions such as Acknowledge, Silence, Reset and Drill. Communication between the N-ANN-80/N-ANN-100 and the FACP is accomplished over a two wire RS-485 serial interface employing the ANN-BUS communication format. The devices are powered, via two additional wires, from either the host FACP or remote UL-listed, filtered, regulated power supply.

The function buttons, keyswitch and piezo sounder may be individually enabled and disabled through the FACP software. Refer to “ANN-80/100 Options” on page 94 for a description of this feature and programming information.

Note that if the keyswitch is enabled and remains in the unlocked position for more than two minutes without any buttons being pressed on the annunciator, a trouble indication will be annunciated.

N-ANN-S/PG Serial/Parallel Interface Module

The N-ANN-S/PG Serial/Parallel Interface module allows the connection of a remote serial or parallel printer to the FACP for a real-time log of system events, detector status reports and event history. The module is provided with a plastic enclosure for surface mounting.

N-ANN-I/O LED Driver Module

The N-ANN-I/O is an LED driver module that can be used in a wide variety of applications, including as an interface with most customized graphic annunciators. The N-ANN-I/O can drive up to 40 LEDs. The module is provided with a plastic wall mount.

N-ANN-LED Annunciator Module

The N-ANN-LED and N-ANN-RLED annunciator modules provide LED annunciation of general system faults and input zones/points when used with a compatible FACP. The N-ANN-LED module provides alarm (red), trouble (yellow) and supervisory (yellow) indication for up to ten input zones or addressable points. The N-ANN-RLED provides alarm (red) indication for up to 30 input zones or addressable points. Multiple N-ANN-(R)LED modules may be used for full system coverage.

N-ANN-RLY Annunciator Module

The N-ANN-RLY relay module provides 10 programmable Form-C relays when used with a compatible FACP.

1.7 Getting Started

The following is a brief summary of the minimal steps involved in bringing an NFW-50X on-line:

- Install Backbox and Main Circuit Board (refer to “Mounting the Backbox” on page 20)
- Address and Install Intelligent Devices (refer to the FireWarden/ONYX SLC Wiring Manuals)
- Enter Autoprogramming (refer to “Autoprogram” on page 49)
- Resolve Programming Conflicts
- Go to Point Program to Enter Specific Data (refer to “Point Program” on page 50). Use the right and left arrow keys to navigate between devices.

1.8 Telephone Requirements and Warnings

1.8.1 Telephone Circuitry

Ringer Equivalence Number (REN) = 0.3A

AC Impedance: 10.0 Mega Ohm

Complies with FCC Part 68

Mates with RJ31X Male Connector

Supervision Threshold: loss of phone line voltage for 2 minutes

The REN is used to determine the quantity of devices which may be connected to the telephone line. Excessive RENs on the telephone line may result in the devices not ringing in response to an incoming call. In most, but not all areas, the sum of the RENs should not exceed five (5.0). To be certain of the number of devices that may be connected to the line as determined by the total RENs, contact the telephone company to determine the maximum REN for the calling area.

Before connecting the control panel to the public switched telephone network, the installation of two RJ31X jacks is necessary. If trouble is experienced with this equipment, for repair or warranty information, please contact:

Manufacturer: Honeywell International, Inc.
12 Clintonville Road
Northford, CT 06472
(203) 484-7161

Product Model Number: **NFW-50X**

FCC Registration Number: **US:1W6AL03AEVOLX**

Ringer Equivalence: **0.3A**



NOTE: This equipment complies with Part 68 of the FCC rules and the requirements adopted by the ACTA. On the inside of the FACP door is a label that contains, among other information, a product identifier in the format US:AAAEQ##TXXXX. If requested, this number must be provided to the telephone company.

Alarm dialing equipment must be able to seize the telephone line and place a call in an emergency situation. It must be able to do this even if other equipment (telephone, answering system, computer modem, etc.) already has the telephone line in use. To do so, alarm dialing equipment must be connected to a properly installed RJ31X jack that is electrically in series with and ahead of all other equipment attached to the same telephone line. If there are any questions concerning these instructions, consult the telephone company or a qualified installer about installing the RJ31X jack and alarm dialing equipment. Refer to “CELL-MOD/CELL-CAB-N” on page 29 for an illustration of the proper installation of this equipment.

Important! The DACT must not be used to dial a phone number that is call-forwarded.

1.8.2 Telephone Company Rights and Warnings

The telephone company, under certain circumstances, may temporarily discontinue services and/or make changes in its facilities, services, equipment or procedures which may affect the operation of this control panel. However, the telephone company is required to give advance notice of such changes or interruptions.

If the control panel causes harm to the telephone network, the telephone company reserves the right to temporarily discontinue service. Advance notification will be provided except in cases when advance notice is not practical. In such cases, notification will be provided as soon as possible. The opportunity will be given to correct any problems and to file a complaint with the FCC if you believe it is necessary.

DO NOT CONNECT THIS PRODUCT TO COIN TELEPHONE, GROUND START, OR PARTY LINE SERVICES.

When the control panel activates, premise phones will be disconnected.

Two separate phone lines are required. Do not connect both telephone interfaces to the same telephone line.

The control panel must be connected to the public switched telephone network upstream (as first device) of any private telephone system at the protected premises.

A plug and jack used to connect this equipment to the premises wiring and telephone network must comply with the applicable FCC Part 68 rules and requirements adopted by ACTA. This equipment is designed to be connected to the telephone network or premises wiring using a compliant RJ31X male modular plug and compatible modular jack that is also compliant.

Section 2: Installation

The cabinet may be either semi-flush or surface mounted. The cabinet mounts using two key slots and two 0.250" (6.35 mm) diameter holes located in the backbox. The key slots are located at the top of the backbox and the two securing holes at the bottom.

Carefully unpack the system and check for shipping damage. Mount the cabinet in a clean, dry, vibration-free area where extreme temperatures are not encountered. The area should be readily accessible with sufficient room to easily install and maintain the panel. Locate the top of the cabinet approximately 5 feet (1.5 m) above the floor with the hinge mounting on the left. Determine the number of conductors required for the devices to be installed. Sufficient knockouts are provided for wiring convenience. Select the appropriate knockout(s) and pull the conductors into the box. All wiring should be in accordance with the National and/or Local codes for fire alarm systems.

2.1 Mounting the Backbox



CAUTION: STATIC SENSITIVE COMPONENTS

THE CIRCUIT BOARD CONTAINS STATIC-SENSITIVE COMPONENTS. ALWAYS GROUND YOURSELF WITH A PROPER WRIST STRAP BEFORE HANDLING ANY BOARDS SO THAT STATIC CHARGES ARE REMOVED FROM THE BODY. USE STATIC SUPPRESSIVE PACKAGING TO PROTECT ELECTRONIC ASSEMBLIES.

To prevent damage to the circuit board and to facilitate backbox mounting, the chassis with main circuit board can be easily removed. Loosen the two 3/8" nuts securing the top flanges of the chassis, then slide the chassis up to free it from the lower tabs. Place the chassis assembly in a safe location until it can be reinstalled in the backbox.

1. Mark and pre-drill hole in the wall for the center top keyhole mounting bolt using the dimensions illustrated in Figure 2.2 on page 21.
2. Install center top fastener in the wall with the screw head protruding.
3. Place backbox over the top screw, level and secure.
4. Mark and drill the left and right upper and lower mounting holes.
Note: Outer holes (closest to sidewall) are used for 16" O.C. stud mounting.
5. Install remaining fasteners and tighten.
6. When the location is dry and free of construction dust, install the chassis/circuit board assembly.
7. Mount the chassis to the backbox by aligning the two mounting tabs with the slots in the backbox, then position the two mounting hole tabs over the studs with nuts located in the upper portion of the backbox.
8. Slide the tabs located on the bottom of the chassis into the mounting slots in the backbox by pressing the chassis down.
9. Secure the chassis to the backbox by tightening the two mounting nuts (#10-32) at the top, and to ensure proper grounding, use a 3/8" nut driver or socket.
10. If the main circuit board is not already attached to the chassis, install it by positioning the ten mounting holes over the studs on the chassis and secure with the supplied screws.

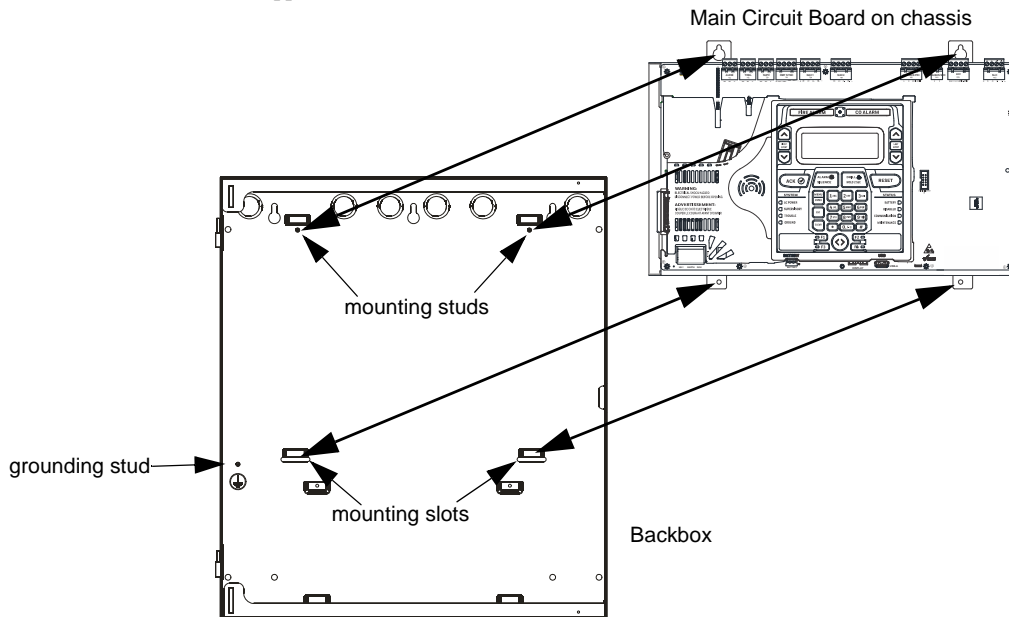

Figure 2.1 NFW-50X Chassis Removal and Installation

es50chassisinbox.wmf

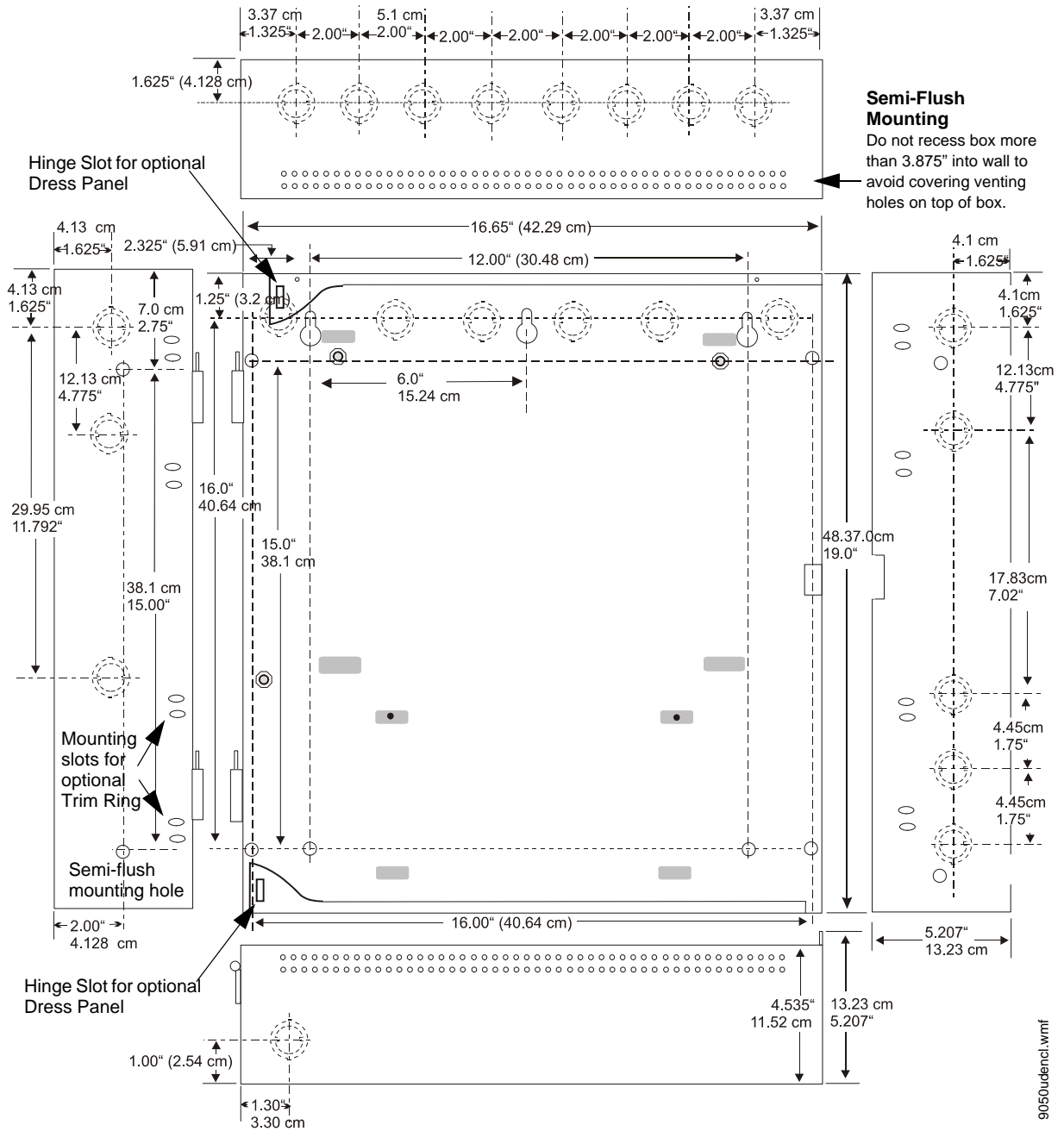
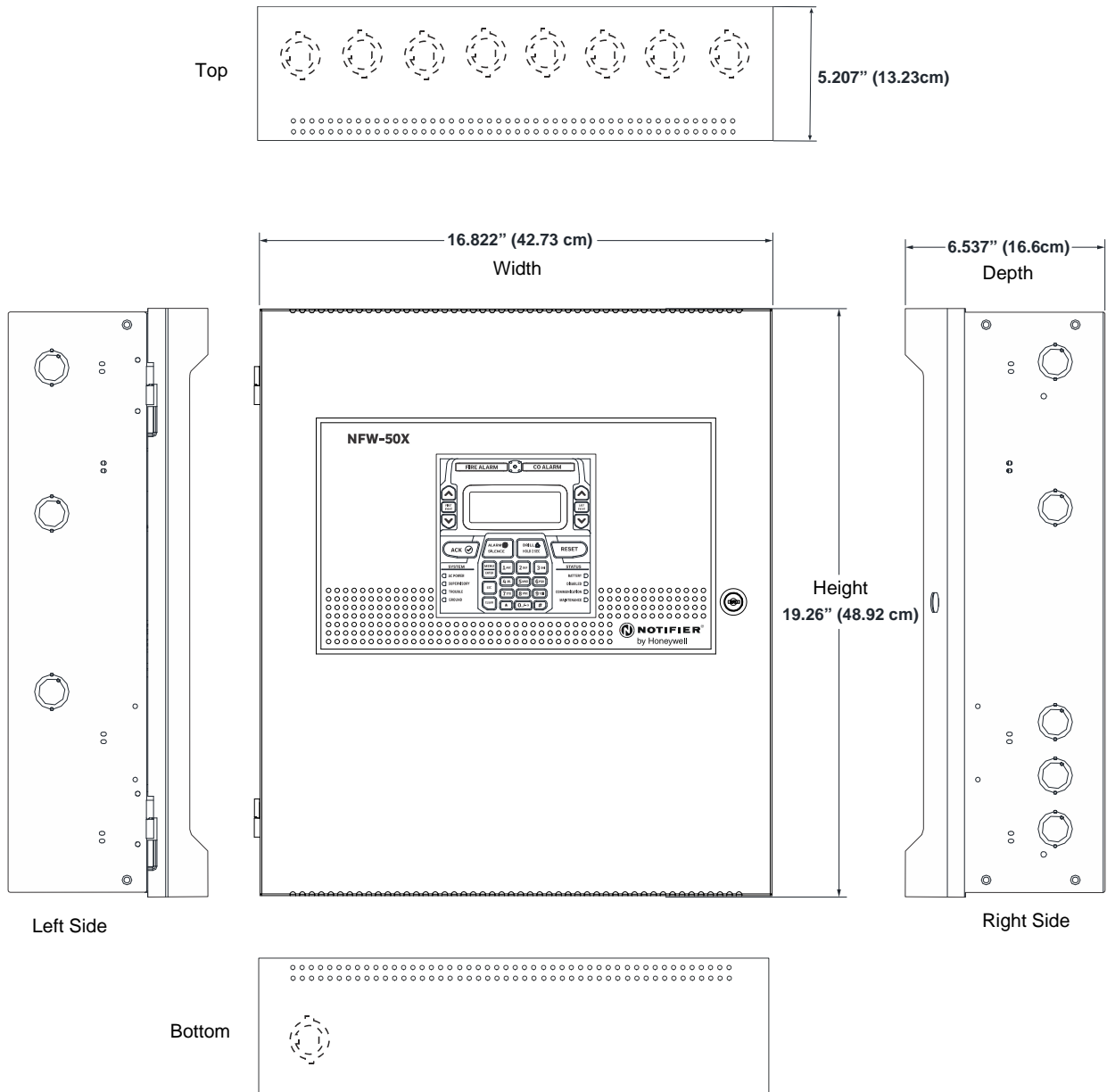

Figure 2.2 NFW-50X Cabinet Mounting



nfw50cab.wmf

Figure 2.3 NFW-50X Cabinet Dimensions

An optional Trim Ring (P/N TR-CE-B) is also available for semi-flush mount installations.

2.2 Power



WARNING: RISK OF EQUIPMENT DAMAGE AND PERSONAL INJURY

SEVERAL DIFFERENT SOURCES OF POWER CAN BE CONNECTED TO THIS PANEL. DISCONNECT ALL SOURCES OF POWER BEFORE SERVICING. THE PANEL AND ASSOCIATED EQUIPMENT MAY BE DAMAGED BY REMOVING AND/OR INSERTING CARDS, MODULES OR INTERCONNECTING CABLES WHILE THIS UNIT IS ENERGIZED.

2.2.1 AC Power and Earth Ground Connection

Primary power required for the FACP is either 120 or 240 VAC, 50/60 Hz, 3.25 amps. The FACP will auto-detect the voltage used. No special switch or jumper is required to select AC power. Overcurrent protection for this circuit must comply with Article 760 of the National Electrical Code (NEC) and/or local codes. Use 14 AWG (2.00 mm²) or larger wire with 600 volt insulation rating. Make certain that the AC mains circuit breaker is **off** before wiring any connections between the mains and the control panel. Connect wiring from the AC mains to TB13 on the FACP, being careful to observe proper connections.

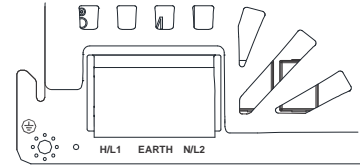

Remove the two keps nuts from the grounding stud in the backbox. Connect the incoming earth ground wire to supplied cable #71073 with a wire nut. Position the ring terminal end over the grounding stud. Secure with one of the keps nuts. Place the ring terminal from the other supplied ground cable #71073 over the ground stud and secure with the second keps nut. Wire the ground cable to the bottom position of TB11. Refer to Figure 2.1 on page 20 for location of the stud. Ensure that the ground for AC mains is the first cable installed, closest to the backbox. This connection is vital in reducing the panel's susceptibility to transients generated by lightning and electrostatic discharge. Apply AC power to the panel only after the system is completely installed and visually checked. *Note that AC power must be applied to the panel before installing the battery interconnect cable (refer to the following section).*

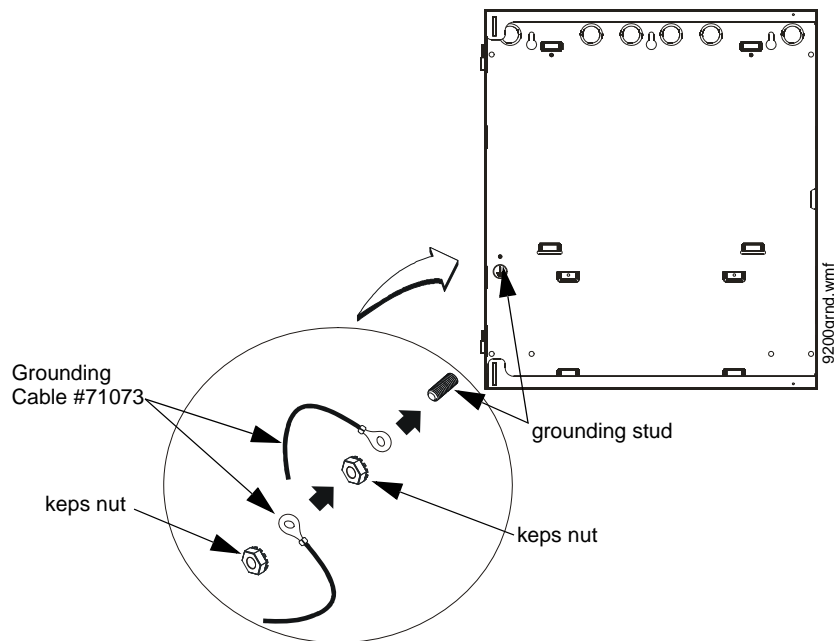
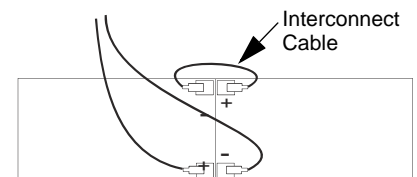

Figure 2.4 Earth Ground Connection

2.2.2 Battery Power

The batteries must be sealed lead acid type. Before connecting the batteries to the FACP, make certain that the interconnect cable between the batteries is **not** connected. Do not connect the interconnect cable until the system is completely installed. Observe polarity when connecting the batteries. Connect the battery cable to J9 on the main circuit board. Refer to "Power Supply Calculations" on page 125, for calculation of the correct battery rating.



WARNING: RISK OF PERSONAL INJURY

BATTERY CONTAINS SULFURIC ACID WHICH CAN CAUSE SEVERE BURNS TO THE SKIN AND EYES AND CAN DESTROY FABRICS. IF CONTACT IS MADE WITH SULFURIC ACID, IMMEDIATELY FLUSH THE SKIN OR EYES WITH WATER FOR 15 MINUTES AND SEEK IMMEDIATE MEDICAL ATTENTION.

2.2.3 Special Application DC Power Output Connection

All Special Application DC power outputs are power-limited (refer to “UL Power-limited Wiring Requirements” on page 27).

Power-limited Non-resettable or Resettable Power
 1.0 amperes max., 24 VDC nominal filtered, non-resettable or resettable power is programmable. Aux Power can be programmed as Class B or Class A.

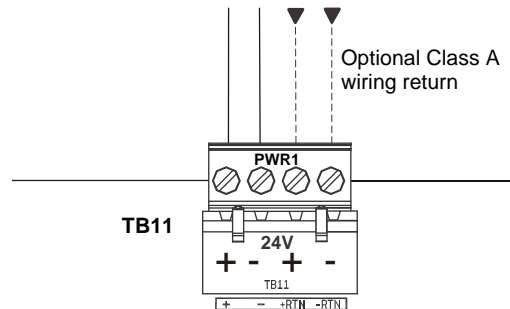

es200tb11.wmf

Figure 2.5 Special Application Power Outputs - 24 VDC

2.3 Relays

The FACP provides two programmable Form-C relays and one fixed fail-safe Form-C trouble relay. Note that relay connections may be power-limited or nonpower-limited, provided that 0.25” spacing is maintained between conductors of power-limited and nonpower-limited circuits. Refer “UL Power-limited Wiring Requirements” on page 27.

Note that the programmable relay labeled as Relay 1 is factory default programmed as Alarm and programmable Relay 3 is factory default programmed as Supervisory. The relay labeled Relay 2 is fixed as a Trouble relay and cannot be changed. It is a fail-safe relay which will transfer on any trouble or total power failure.

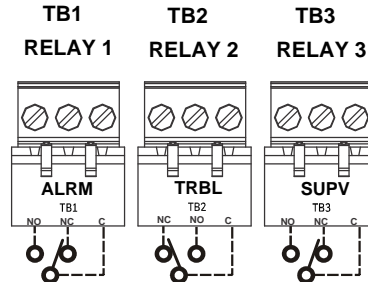

Relay contacts shown with power applied to panel and no active troubles, alarms or supervisories

es200rly.wmf

Figure 2.6 Relay Terminals

2.4 Notification Appliance Circuits

The control panel provides two Class B or four Class A NACs (Notification Appliance Circuits). Each circuit is capable of 2.5 amps of current. Total current in alarm for all external devices cannot exceed 6.0 amps (refer to “Calculating the System Current Load” on page 125). Use UL listed 24 VDC notification appliances only. Circuits are supervised and power-limited. Refer to the *Device Compatibility Document* for a listing of compatible notification appliances. The NACs, which are located on the main circuit board, may be expanded via the FCPS Series field charger/power supplies.

The following sections describe the configuration and wiring of Class B and Class A Notification Appliance Circuits on the NFW-50X main circuit board.

2.4.1 Class B NAC Wiring

2 Class B Notification Appliance Circuits, supervised and power-limited - 4.7 kΩ, ½ watt P/N:71252 UL listed

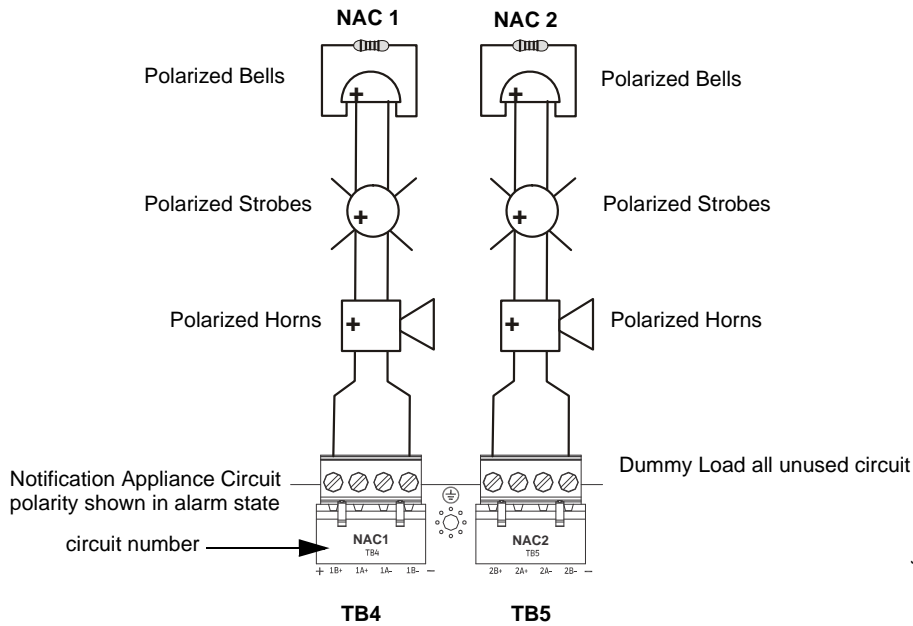

Figure 2.7 NAC Class B Wiring

2.4.2 Class A NAC Wiring

2 Class A Notification Appliance Circuits, supervised and power-limited

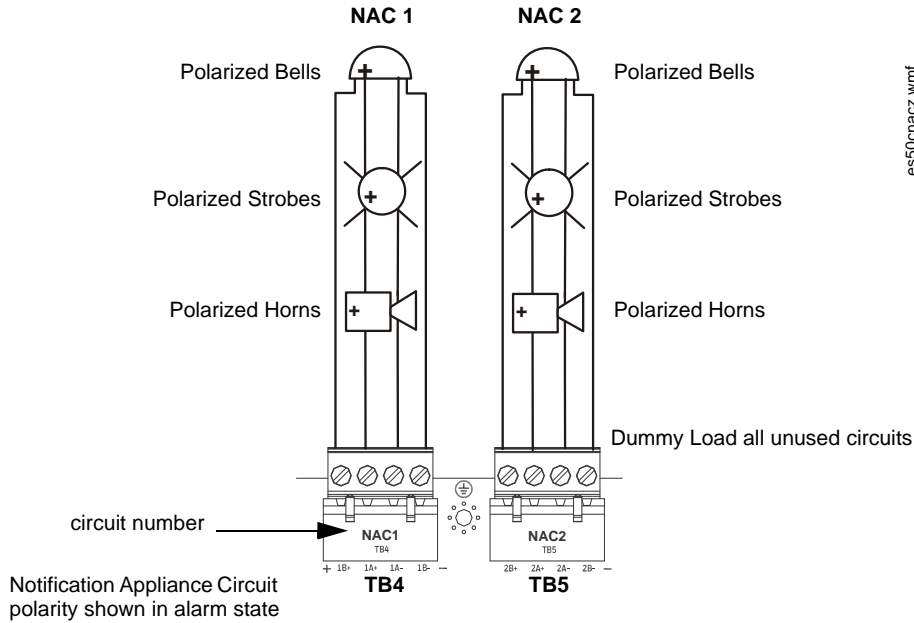

Figure 2.8 NAC Class A Wiring

2.5 Remote Synchronization Output

Synchronization is a feature that controls the activation of notification appliances in such a way that all devices will turn on and off at exactly the same time. This is particularly critical when activating strobes which must be synchronized to avoid random activation and a potential hazard to individuals. Devices connected directly to the control panel’s NACs can be synchronized as described in “Type” on page 73.

Notification appliances connected to FCPS NAC power supplies require synchronization with the FACP’s devices. This can be accomplished by connecting the Remote Synchronization Output from TB8 of the NFW-50X to the sync input of the FCPS-24S6/8 Power Supply. The 24 VDC signal from TB8 follows, that is mimics, the signal on NAC1. This allows the devices connected to the power supply to be synchronized with the devices connected to NAC1 on the FACP.

The Remote Synchronization Output is power-limited and supervised (refer to “UL Power-limited Wiring Requirements” on page 27) and can be wired in Class B or Class A. A 4.7 KΩ ELR resistor must be connected to the end of the wiring at the remote power supply for Class B wiring. Supervision of the remote synchronization is automatically enabled when the remote sync output is enabled. Supervision will be disabled if the output is disabled. For more information on enabling the remote sync output, refer to page 100.

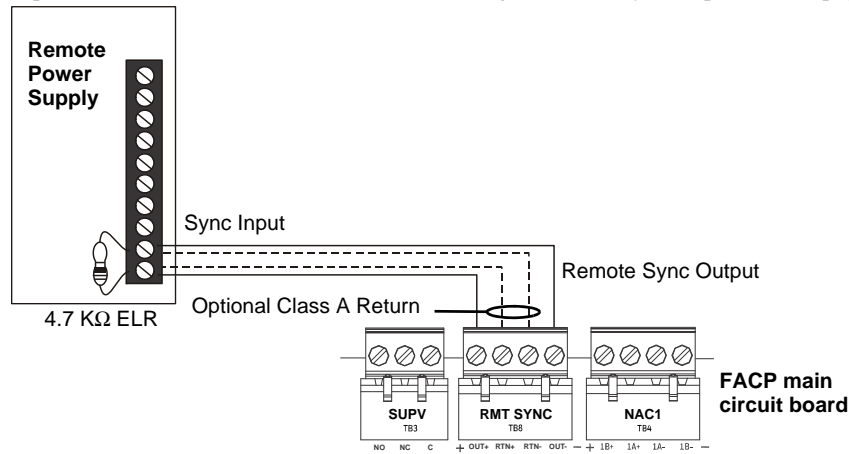

es200sync.wmf

Figure 2.9 Remote Sync Output

2.6 UL Power-limited Wiring Requirements

Power-limited and nonpower-limited circuit wiring must remain separated in the cabinet. All power-limited circuit wiring must remain at least 0.25" (6.35 mm) away from any nonpower-limited circuit wiring and nonpower-limited circuit wiring must enter and exit the cabinet through different knockouts and/or conduits. When connecting the ground cables, be sure that the AC mains ground is the first one installed, closest to the backbox. A typical wiring diagram for the NFW-50X is shown below.

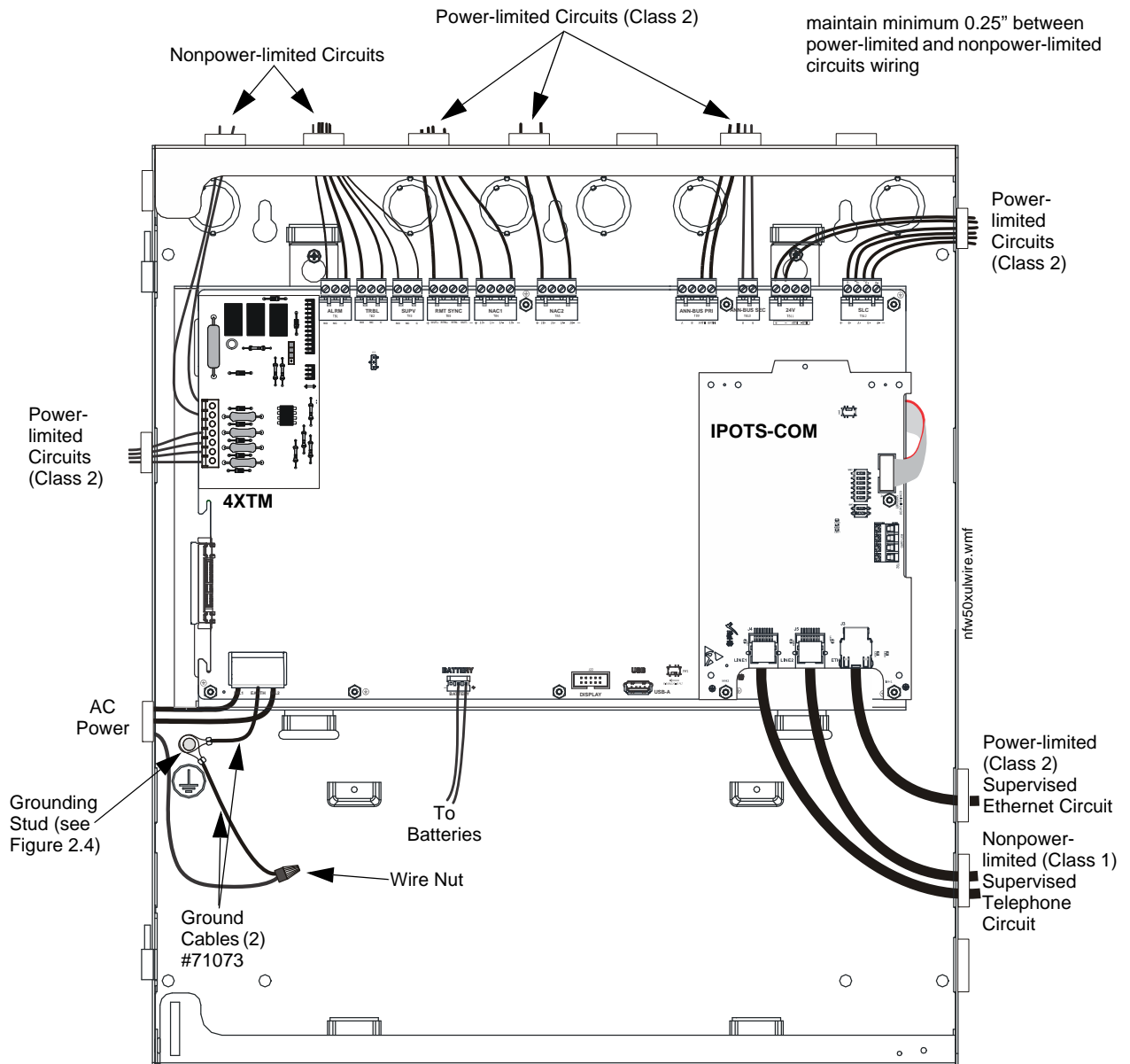

Figure 2.10 Typical UL Power-limited Wiring Requirements

2.7 IPOTS-COM Communicator

Two independent telephone lines can be connected to the control panel via the IPOTS-COM Phone/IP Communication Module. Telephone line control/command is made possible via double line seizure as well as usage of an RJ31X style interconnection. *Note that it is critical that the IPOTS-COM Digital Communicator be located as the first device on the incoming telephone circuit to properly function.* **Important!** The IPOTS-COM must not be used to dial a phone number that is call-forwarded.

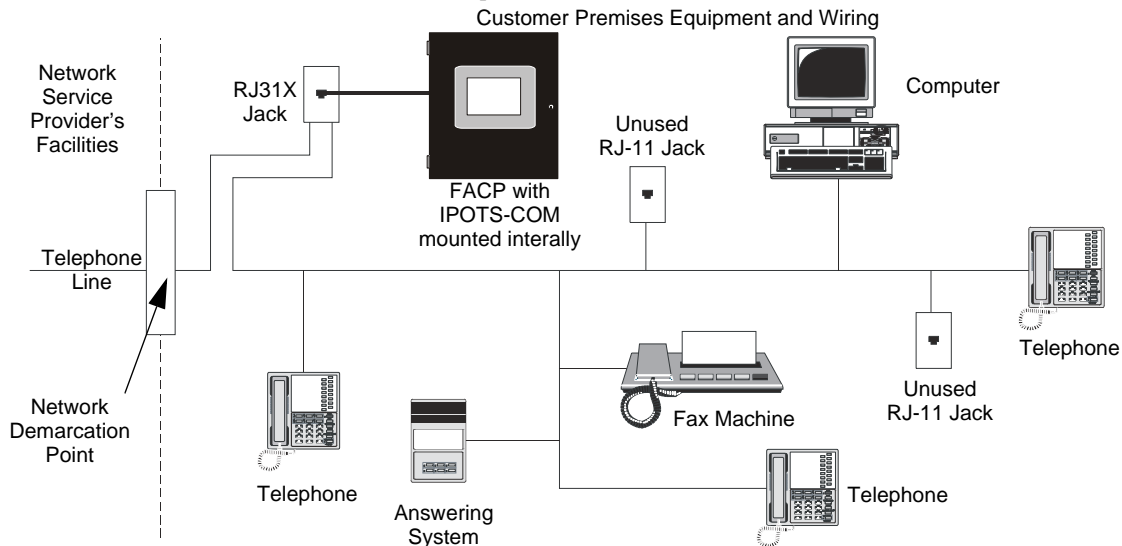

Figure 2.11 Communicator Installation

Wiring

Connection and wiring of two phone lines is required as shown below.

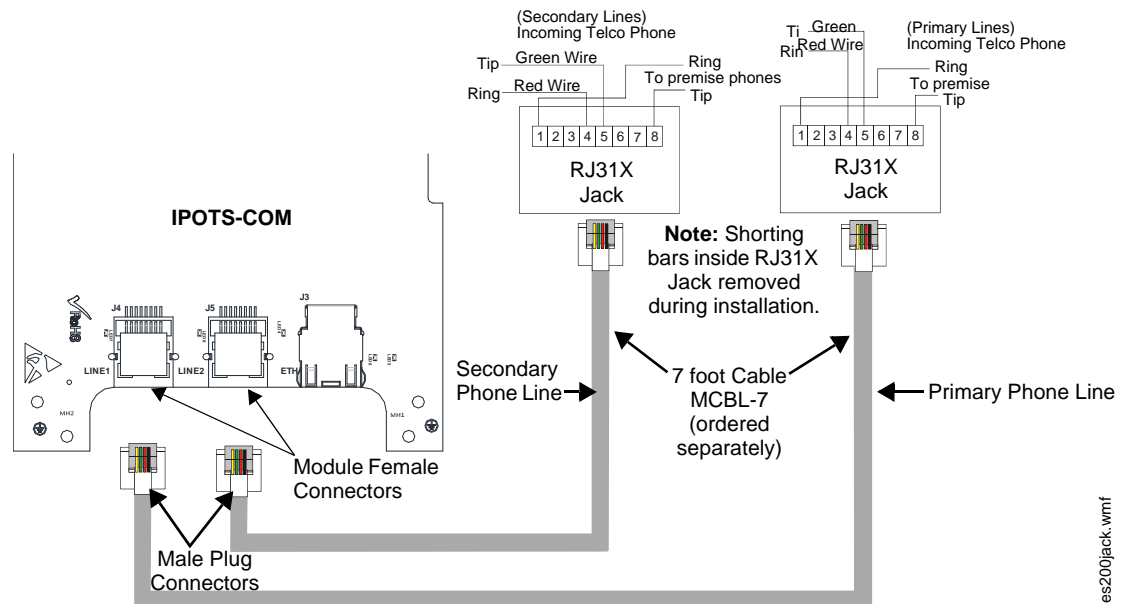

Figure 2.12 Wiring Phone Jacks

Dip Switches

There are two configurable dip switches on the IPOTS-COM communicator.

- SW2: 6-position dip switch- FUTURE USE- No configuration necessary.
- SW3: 2-position dip switch- Factory Settings- Do not change unless instructed to do so by Honeywell.

Figure 2.13 IPOTS-COM Dip Switches

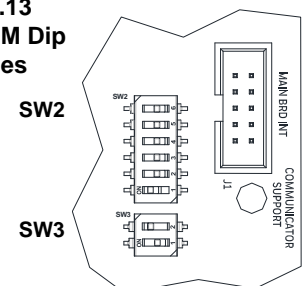

2.8 Optional Module Installation



WARNING: RISK OF ELECTRIC SHOCK AND EQUIPMENT DAMAGE

DISCONNECT ALL SOURCES OF POWER (AC AND DC) BEFORE INSTALLING OR REMOVING ANY MODULES OR WIRING.

2.8.1 CELL-MOD/CELL-CAB-N

The CELL-MOD/CELL-CAB-N offers an optional GSM communicator card for central station reporting. It mounts in its own plastic or metal enclosure. Use of the CELL-MOD/CELL-CAB-N requires the IPOTS-COM communicator.

Installation

Install the CELL-CAB-N as described in the Product Installation Document #LS10186-001NF-E and the CELL-MOD as described in #LS10182-000GE-E.

Wiring

Connections are made from TB2 on the IPOTS-COM board to the terminal on the GSM card as shown below.

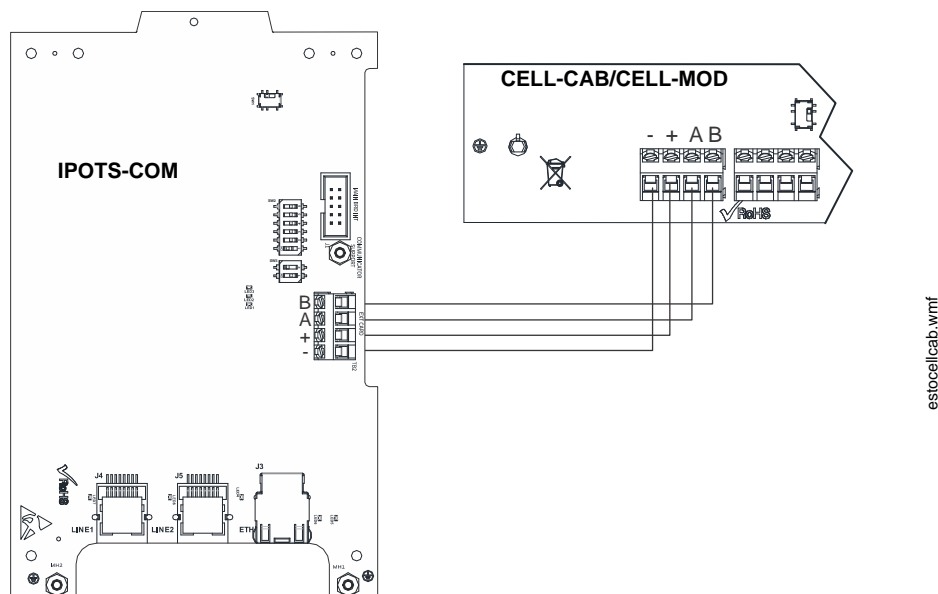

Figure 2.14 Wiring the CELL-CAB/CELL-MOD

2.8.2 4XTM Transmitter Module Installation

The 4XTM provides a supervised output for a local energy municipal box transmitter in addition to alarm and trouble reverse polarity. A jumper option allows the reverse polarity circuit to open with a system trouble condition if no alarm condition exists. A disable switch allows disabling of the transmitter output during testing to prevent accidental calling of the monitoring service.

Local Energy Municipal Box Service (NFPA 72 Auxiliary Fire Alarm Systems):

Supervisory Current: 5.0 mA

Trip Current: 350 mA (subtracted from notification appliance power)

Coil Voltage: 3.65 VDC

Maximum Coil Resistance: 14.6 ohms

Maximum allowable wire resistance between panel and trip coil: 3 ohms

Municipal Box wiring can leave the building

Remote Station Service (NFPA 72 Remote Station Fire Alarm Systems) - Intended for connection to a polarity reversal circuit or a Remote Station receiving unit having compatible ratings:

Maximum load for each circuit: 10 mA

Reverse polarity output voltage: 24 VDC

Remote Alarm and Remote Trouble wiring can leave the building

Before installing the module, place the disconnect switch to the right (disconnect) position to prevent accidental activation of the municipal box. Note that a Disconnect LED will illuminate after the module is installed in the NFW-50X. In addition, the System Trouble LED will turn on to indicate the Disconnect condition.

Note: The 4XTM Module is not directly suitable for transmitting a reverse polarity supervisory signal. For applications using reverse polarity of a supervisory signal, refer to "FACP with Keltron" on page 153.

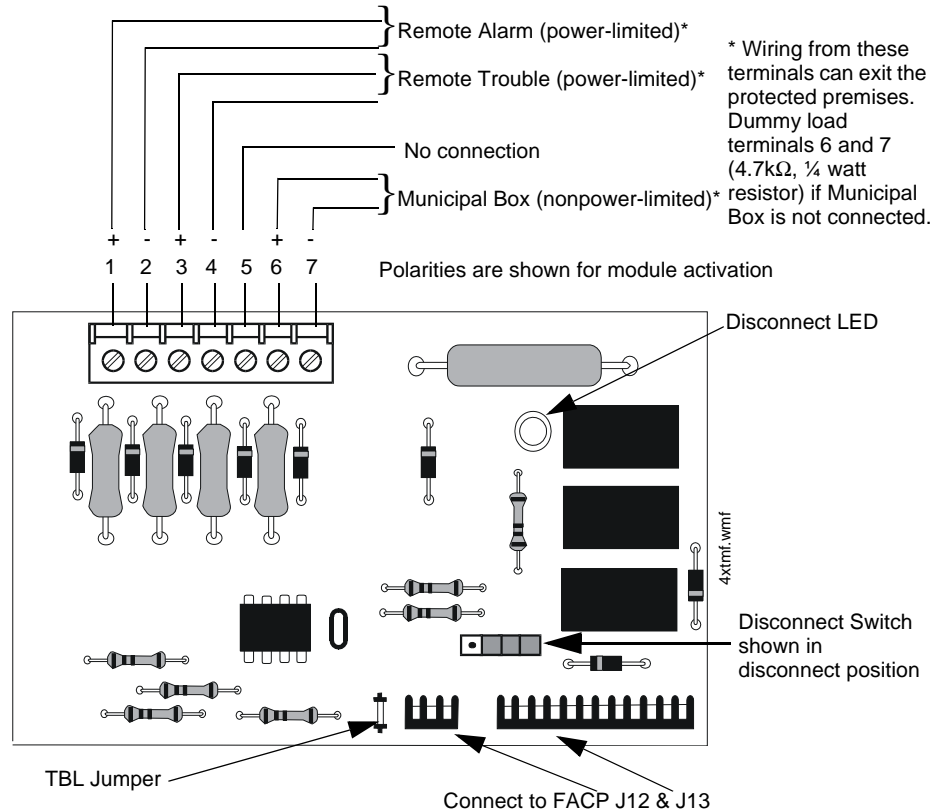

Figure 2.15 4XTM Transmitter Module

The following steps must be followed when installing the 4XTM module:

1. Remove all power (Primary and Secondary) from the FACP before installing 4XTM
2. Carefully plug the connectors on the 4XTM module into connectors J12 and J13 on the NFW-50X main circuit board, being careful not to bend any pins.
3. Secure 4XTM module to standoffs with supplied screws.
4. Slide SW2 on the NFW-50X main circuit board to the down position.
5. Enable 4XTM supervision in user programming. Refer to "4XTM Supervision" on page 76.
6. Reapply power to the FACP.
7. For proper 4XTM operation, the output relays must be programmed for the factory default settings: Alarm Relay 1, Trouble Relay 2 and Supervisory Relay 3.
8. When the installation has been complete, enable the 4XTM module by sliding the disconnect switch to the left.
9. Test system for proper operation.

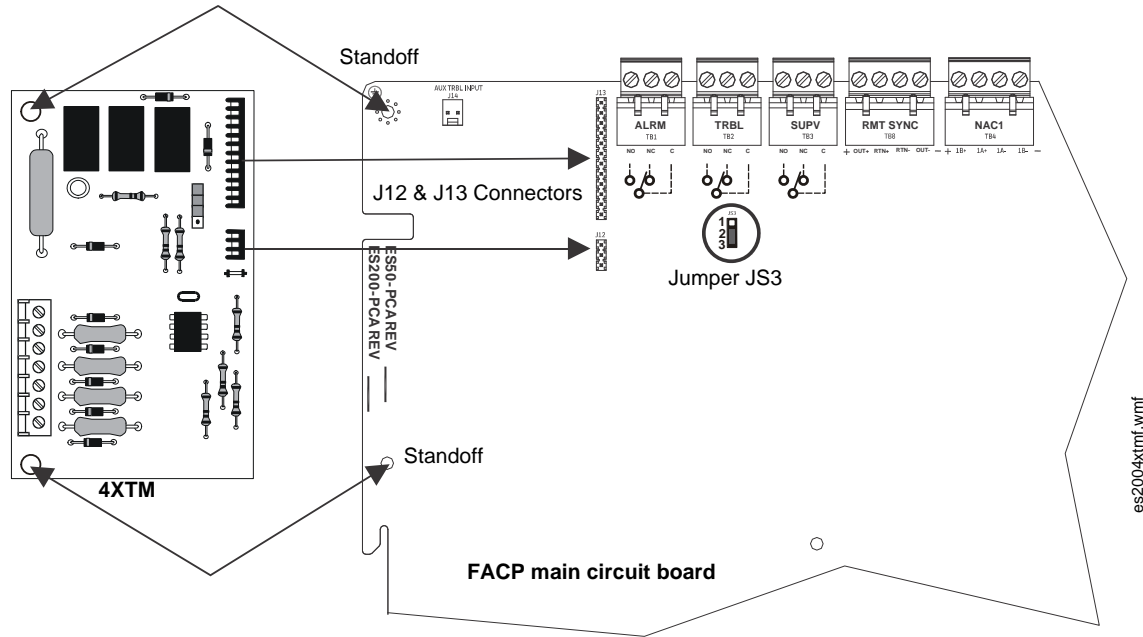

Figure 2.16 4XTM Connectors to NFW-50X Connectors



NOTE: When a 4XTM is installed, enable supervision in panel programming. Jumper JS3 on the FACP main circuit board can be used to configure the FACP supervisory relay for operation with the 4XTM module. Relay 3 at TB3 must be programmed as a supervisory relay. Jumpering pins 2&3 on JS3 will allow the 4XTM to generate a trouble if the supervisory contact opens. Jumpering pins 1&2 on JS3 in will prevent generation of a trouble if the supervisory contact opens.

2.8.3 ANN-BUS Annunciators/Modules

ANN-BUS Wiring

This section contains information on calculating ANN-BUS wire distances and the types of wiring configurations (Class B).

■ Calculating Wiring Distance for ANN-BUS Modules

The following instructions will guide the installer in determining the type of wire and the maximum wiring distance that can be used with FACP ANN-BUS accessory modules.

To calculate the wire gauge that must be used to connect ANN-BUS modules to the FACP, it is necessary to calculate the total worst case current draw for all modules on a single 4-conductor bus. The total worst case current draw is calculated by adding the individual worst case currents for each module. The individual worst case values are shown in the following table:

Model Number	Worst Case Current Draw ¹
N-ANN-80 LCD Annunciator	0.040 amps
N-ANN-100 LCD Annunciator	0.025 amps
N-ANN-S/PG Serial/Parallel Printer Interface Module	0.040 amps
N-ANN-I/O LED Driver Module	0.200 amps
N-ANN-(R)LED Annunciator Module	0.068 amps
N-ANN-RLY Relay Module	0.075 amps

¹ When powering the ANN-BUS from one of the (nonresettable) DC power outputs at TB11, the total worst case current draw cannot exceed 1.0 amp. If sharing this DC output with other devices, the worst case current drawn by these devices must be combined with the ANN-BUS current draw, and the total cannot exceed 1.0 amp. If the total current demand exceeds 1.0 amp, refer to "Powering ANN-BUS Devices from an Auxiliary Power Supply" on page 33.

In general, the wire length is limited by resistance, but for heavier wire gauges, capacitance is the limiting factor. Maximum length can never be more than 6,000 feet (1,800 m), regardless of gauge used. The following formulas are used to generate the wire distances:

$$\text{Maximum Resistance (Ohms)} = \frac{2.0 \text{ Volts}}{\text{Total Worst Case Current Draw (amps)}}$$

$$\text{Maximum Wire Length (feet)} = \frac{\text{Maximum Resistance (Ohms)}}{\text{Rpu}} \times 500$$

(6,000 feet maximum)

where: Rpu = Ohms per 1,000 feet for various Wire Gauges (see table below)

Wire Gauge	Ohms per 1,000 feet (Rpu)
22	16.2
18	6.4
16	4.02
14	2.54

Exception: When using the N-ANN-RLY module, the installer must ensure that the maximum 24VDC power line drop does not exceed 0.3 volts. This results in the following wiring limitations:

Wire Gauge	Maximum Wire Length
18	312 feet
16	497 feet
14	787 feet
12	1,250 feet

Wiring Distance Calculation Example:

Suppose a system is configured with the following ANN-BUS modules:

- 3 N-ANN-80 Remote Fire Annunciators
- 1 N-ANN-S/PG Serial/Parallel Printer Interface Module

The total worst case current is calculated as follows:

N-ANN-80 Current Draw	= 3 X 0.040 amps	= 0.120 amps
N-ANN-S/PG Current Draw	= 1 X 0.040 amps	= 0.040 amps
Total Worst Case Current Draw		= 0.160 amps

Wiring Configuration

Figure 2.17 illustrates the wiring between the FACP's Primary ANN-BUS and ANN-BUS devices.

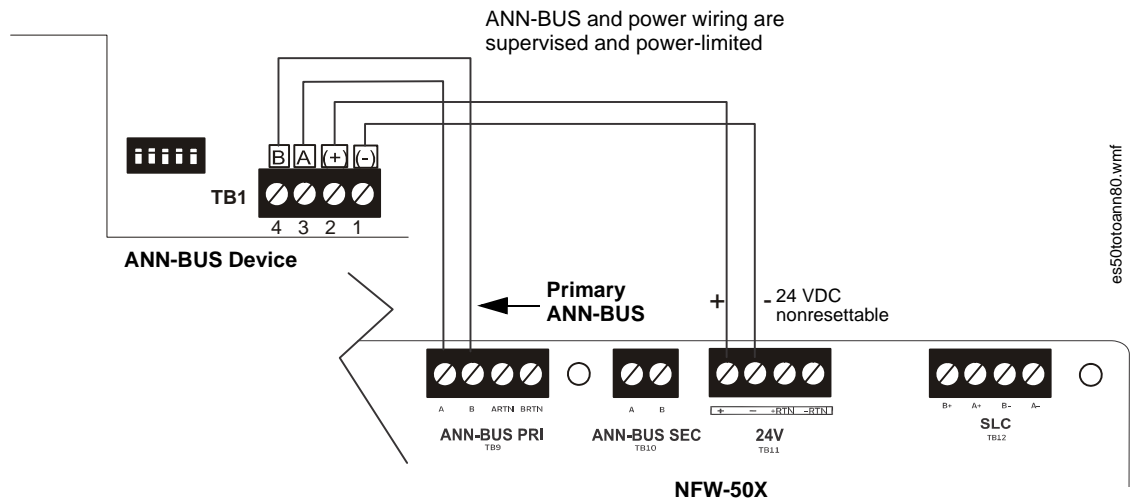
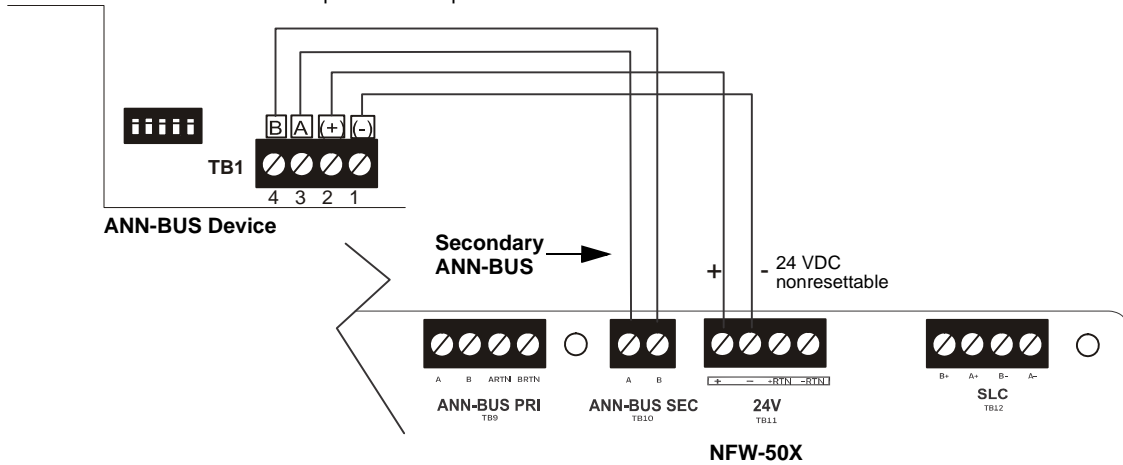

Figure 2.17 Primary ANN-BUS wiring to ANN-BUS Device

Figure 2.18 illustrates the wiring between the FACP's Secondary ANN-BUS and ANN-BUS devices. ANN-BUS and power wiring are supervised and power-limited



es50toann802.wmf

Figure 2.18 Secondary ANN-BUS wiring to ANN-BUS Device

■ Powering Both ANN-BUS Circuits Simultaneously

When simultaneously using the Primary and Secondary ANN-BUS circuits on the FACP, power can be shared from the Nonresettable Power output on TB11. Alternately, one ANN-BUS can be powered by the Resettable Power output (TB11 Terminals 3 and 4) once it is reconfigured as Nonresettable Power in panel programming. This provides the benefit of independently acting power-limiting for the two ANN-BUS circuits.

■ Powering ANN-BUS Devices from an Auxiliary Power Supply

Figure 2.19 illustrates the powering of ANN-BUS devices from an auxiliary power supply such as the FCPS-24S6/8, when the total ANN-BUS power requirements exceed the panel's DC Power Output capability.

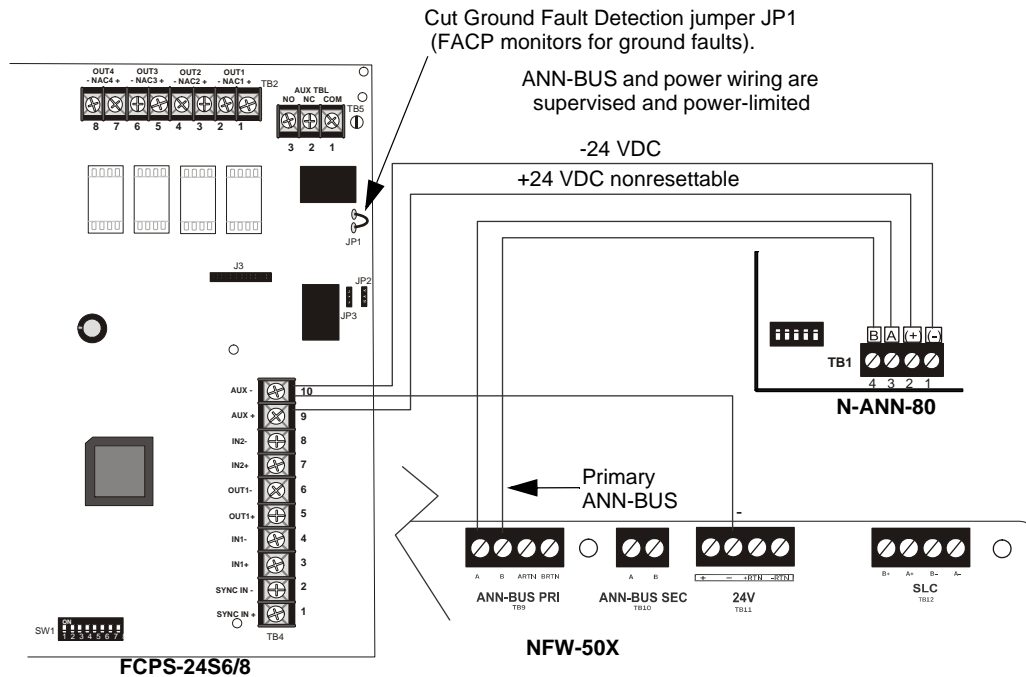

es50tofcps2oann.wmf

Figure 2.19 Powering ANN-BUS Devices from FCPS-24S6/8

ANN-BUS Device Addressing

Each ANN-BUS device requires a unique address (ID Number) in order to communicate with the FACP. A 5-position DIP switch on each device is used to set this address. The address set for these devices must also be programmed at the FACP for the specific device (refer to the programming section titled “ANN-BUS Setup” on page 86).

A maximum of 8 devices can be connected to each FACP ANN-BUS communication circuit. Device addresses do not need to be sequential and can be set to any number between 01 and 08. This applies to both ANN-BUS communication circuits. Note that 00 is not a valid address. The following table shows the DIP switch setting for each address.



NOTE: Address (ID Number) DIP switches on some devices may have more than 5 switch positions. Unless otherwise specified in the documentation supplied with each device, switch positions 6 and above must be set to **OFF**.

Address	Switch 5	Switch 4	Switch 3	Switch 2	Switch 1
not valid	OFF	OFF	OFF	OFF	OFF
01	OFF	OFF	OFF	OFF	ON
02	OFF	OFF	OFF	ON	OFF
03	OFF	OFF	OFF	ON	ON
04	OFF	OFF	ON	OFF	OFF
05	OFF	OFF	ON	OFF	ON
06	OFF	OFF	ON	ON	OFF
07	OFF	OFF	ON	ON	ON
08	OFF	ON	OFF	OFF	OFF

Switch 5 must be set to OFF for ANN-BUS devices to be recognized.

N-ANN-80 Remote Fire Annunciator

■ Specifications

- Operating Voltage Range: 18 VDC to 28 VDC
- Current Consumption @ 24 VDC nominal (filtered and nonresettable):
 - ✓ Normal/Standby (no activity): 37.0 mA
 - ✓ Trouble: 39.0 mA
 - ✓ Alarm: 40.0 mA
 - ✓ AC Fail (not backlit): 15.0 mA
- For use indoors in a dry location

■ Installation

Ensure that all power (AC and DC) has been removed from the FACP before installing the annunciator.

■ Opening/Closing Annunciator

The following procedure details the steps used to open the annunciator in order to access the terminal block and DIP switches (refer to figure below):

1. Turn the key switch to the ON (Unlocked) position by turning the key counter-clockwise.
2. Push in the snap latch located on the right side of the unit while pulling the cover open.
3. To close the cover, make certain the key switch is in the ON (Unlocked) position. Swing the cover closed, snapping it shut.
4. Turn the key switch to the OFF (Locked) position by turning clockwise and remove the key.

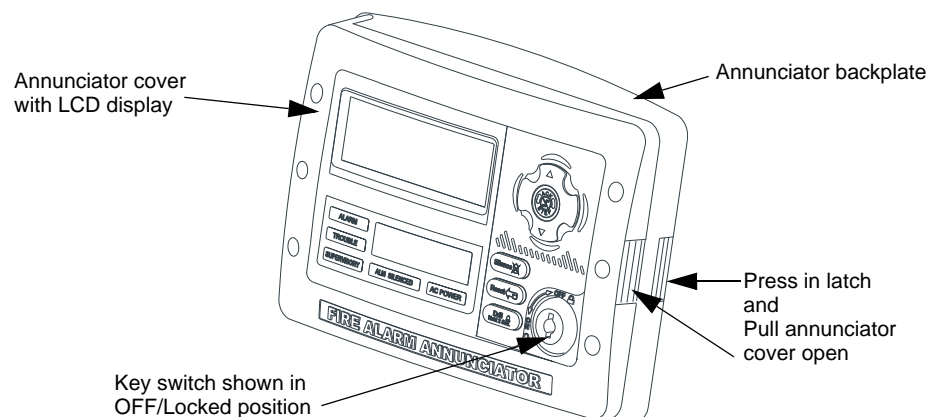

■ Mounting

The N-ANN-80 can be surface or semi-flush mounted to a single, double or 4" square electrical box. Select and remove the appropriate knockout(s), pull the necessary wires through the knockouts and mount the annunciator in or on the wall depending on the type of installation desired.

The ANN-SB80KIT(-R/-B/-W) is an available mounting kit for the N-ANN-80 annunciator. The kit comes with a surface backbox and surface wedge for angled viewing. The two pieces can be used separately or can be stacked together.

The N-ANN-80 cover must be attached to the annunciator backplate before mounting the annunciator to the electrical box/wall. The cover cannot be reattached or removed after the annunciator has been mounted.

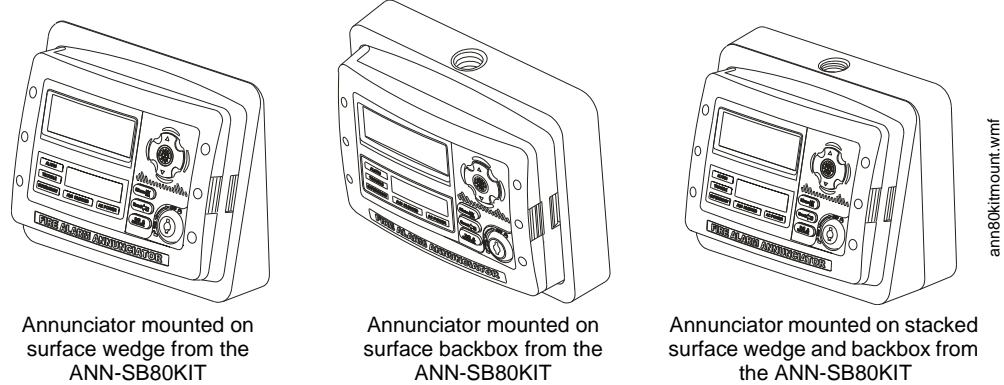

■ Wiring N-ANN-80 to FACP

The following steps can be used as a guide to wire the annunciator. Make certain all power has been removed from the FACP prior to annunciator installation.

1. Route wires from hole in backplate, through wiring channel and then to N-ANN-80 terminal block TB1

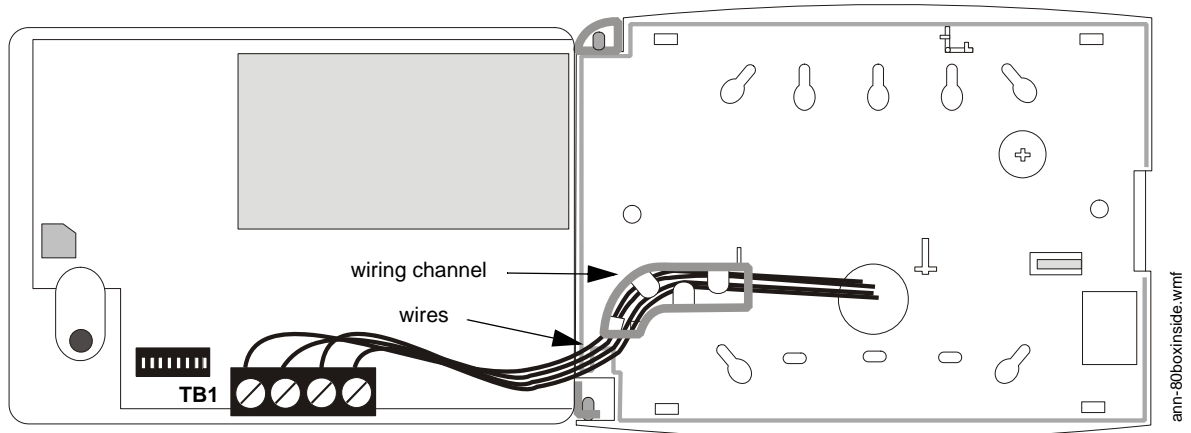

2. Remove appropriate amount of wire insulation
3. Connect the wiring from the FACP ANN-BUS to annunciator TB1 terminals 3 (A) & 4 (B). Make certain to connect A to A and B to B
4. If appropriate, connect the wiring going to the next device on the ANN-BUS to TB1 terminals 3 & 4. Make certain to connect A to A and B to B
5. Connect the wiring from the 24 VDC power source to annunciator TB1 terminals 1 (-) & 2 (+). Make certain to observe proper polarity
6. If appropriate, connect the power wiring going to the next device to terminals 1 (-) & 2 (+). Make certain to observe proper polarity

- After all connections are made, remove extra wire from inside of annunciator by dressing it neatly through wire channel, with any excess wire pushed back through hole into electrical box

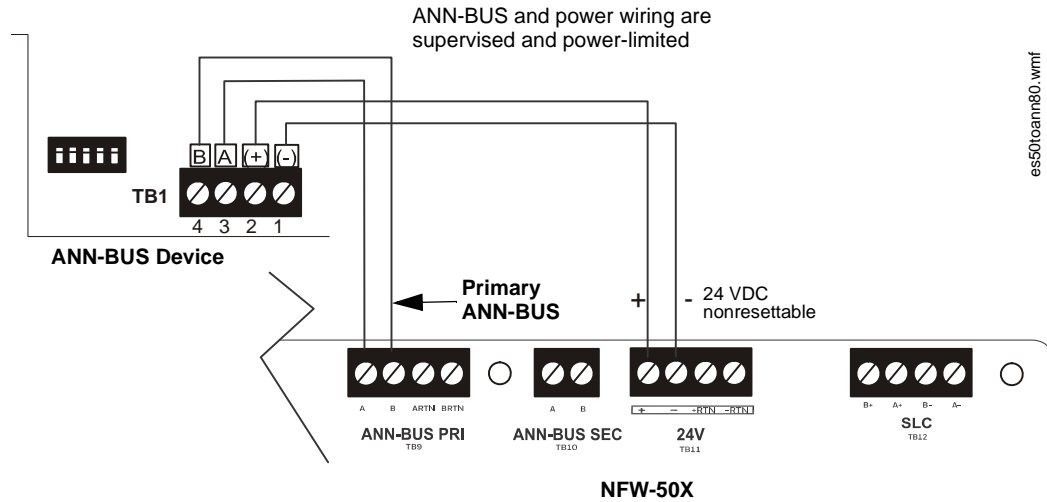

Figure 2.20 N-ANN-80 Wiring to FACP

The following table shows the N-ANN-80 connections to the NFW-50X.

NFW-50X	N-ANN-80 (TB1)
Terminal GND (-) on TB11	Terminal 1 (-)
Terminal PWR (+) on TB11	Terminal 2 (+)
Terminal Data (A) on TB9	Terminal 3 (A)
Terminal Data (B) on TB9	Terminal 4 (B)

■ Programming

Following installation and wiring of the N-ANN-80 LCD annunciator to the FACP, the annunciator must be added to the system via FACP programming. Refer to the programming section titled “ANN-BUS Setup” on page 86 in this manual for detailed programming information. Select the LCD option for programming.

■ Trouble Response

If the N-ANN-80 is installed but the ANN-BUS is not enabled at the FACP, the N-ANN-80 will indicate a trouble condition by NOT turning on its AC Power indicator. The LCD will also display *Key Bus Trouble* and the piezo will sound approximately once every 10 seconds. Note that the FACP will provide no indication of an N-ANN-80 trouble.

To clear the N-ANN-80 trouble condition, enable the ANN-BUS and program the address corresponding to the address set on the N-ANN-80 at the FACP.

N-ANN-100 Remote Fire Annunciator

■ Specifications

- Operating Voltage: 24 VDC
- Current
 - Standby: 20 mA
 - Alarm: 25 mA
- Ambient Temperature: 32°F to 120°F (0°C to 49°C)
- Max. Wiring Distance from FACP: 6,000 ft. (1,800 m)
- Mounting: Surface or Flush-mount
- Dimensions: 12-1/4”W x 11-1/2”H x 7/8”D (31.1 cm W x 29.2 cm H x 2.2 cm D)
- For indoor use in a dry location only

The following table shows the N-ANN-100 connections to the NFW-50X.

NFW-50X	N-ANN-100 (TB1)
Terminal GND (-) on TB11	Terminal 1 (-)
Terminal PWR (+) on TB11	Terminal 2 (+)
Terminal Data (A) on TB9	Terminal 3 (A)
Terminal Data (B) on TB9	Terminal 4 (B)

■ Programming

Following installation and wiring of the N-ANN-100 LCD annunciator to the FACP, the annunciator must be added to the system via FACP programming. Refer to the programming section titled “ANN-BUS Setup” on page 86 in this manual for detailed programming information.

■ Trouble Response

If the N-ANN-100 is installed but the ANN-BUS is not enabled at the FACP, the N-ANN-100 will indicate a trouble condition by NOT turning on its AC Power indicator. The LCD will also display *Key Bus Trouble* and the piezo will sound approximately once every 10 seconds. Note that the FACP will provide no indication of an N-ANN-100 trouble.

To clear the N-ANN-100 trouble condition, enable the ANN-BUS and program the address corresponding to the address set on the N-ANN-100 at the FACP.

N-ANN-S/PG Serial/Parallel Interface Module

■ Installation

1. Ensure that all power (AC and DC) has been removed from the FACP.
2. Connect the N-ANN-S/PG to the FACP as illustrated in Figure 2.21

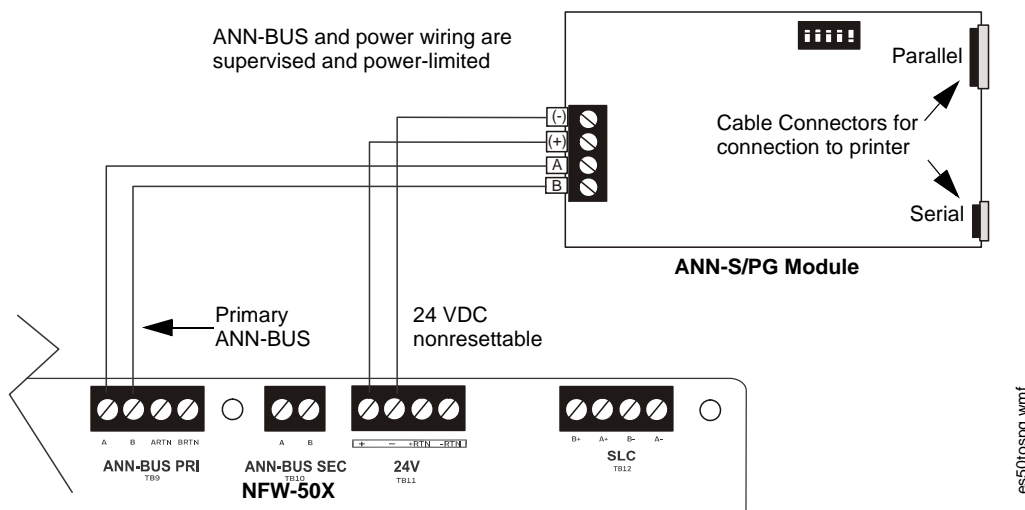

Figure 2.21 ANN-S/PG Connection to FACP

3. Using the DIP switches on the back of the N-ANN-S/PG module, assign an ID number (address) to the module.
4. Select the address and configuration options for the N-ANN-S/PG module as described in the Programming section of this manual (refer to “ANN-BUS Setup” on page 86).
Note that the Auto-configure feature allows the programmer to quickly bring all installed ANN-BUS modules online (refer to “Auto-Configure” on page 93).
5. Connect a printer to the N-ANN-S/PG Parallel or Serial connectors (refer to Figure 2.21). Only one printer can be connected.

■ Specifications

- Operating Voltage: 24 VDC
- Current (Alarm and Standby): 45 mA
- Ambient Temperature: 32°F to 120°F (0°C to 49°C)
- Max. Wiring Distance from FACP: 6,000 ft. (1,800 m)
- Mounting: Surface
- Dimensions: 6”W x 7-3/4”H x 1-7/16”D (15.2 cm W x 19.7 cm H x 3.7 cm D)
- For indoor use in a dry location only

■ Connecting a PRN-7 Printer

Remote printers require a primary AC power source. If required for the fire alarm system configuration (for example, a Proprietary Fire Alarm System), a remote printer requires a secondary power source (battery backup). Since a secondary power source is not provided as a standard feature, a separate UL-listed Uninterruptible Power Supply (UPS) should be used. The building emergency power supply may be used, as long as it meets the power continuity requirements of NFPA 72. Refer to NFPA 72 for further details.

Connect the remote printer to the FACP via the N-ANN-S/PG module using a standard DB-9 cable. One end of the cable will plug into the DB-9 connector on the PRN-7 printer and the other end plugs into the serial connector on the N-ANN-S/PG module.

■ Setting Printer Options

Refer to the documentation supplied with the PRN-7 printer for instructions on using the printer menu controls. Set the printer options (under the menu area) as shown in the following table:

Option	Setting	Option	Setting
Font	HS Draft	CPI	10CPI
LPI	6 LPI	Skip	0.5
ESC Character	ESC	Emulate	LQ-2550
Bidirectional Copy	ON	I/O	
CG-TAB	Graphic	Buffer	64K
Country	E-US ASCII	Serial	
Auto CR	OFF	Baud	9600 or 2400
Color Option	Not Installed	Format	7 Bit, Even, 1 Stop
Formien		Protocol	XON/XOFF
Lines	6LPI=60	Character Set	Standard
Standard	Exec 10.5	Sl.Zero	On
Barcode	Off	Auto LF	On
Barcode	Unsecured		

Table 2.1 PRN-7 Setup Options

■ PRN-6 Printer Installation

When connected to the FACP via the N-ANN-S/PG module, the PRN-6 prints the status changes within the control panel and time-stamps the printout with the time of day and date that the event occurred. It provides 80 columns of data on standard 9" x 11" tractor-feed paper. This section contains information on connecting a printer to the control panel and setting the printer options.

Connecting PRN-6 Printer

Remote printers require a primary AC power source. If required for the fire alarm system configuration (for example, a Proprietary Fire Alarm System), a remote printer requires a secondary power source (battery backup). Since a secondary power source is not provided as a standard feature, a separate UL-listed Uninterruptible Power Supply (UPS) should be used. The building emergency power supply may be used, as long as it meets the power continuity requirements of NFPA 72. Refer to NFPA 72 for further details.

Connect the remote printer to the FACP via the N-ANN-S/PG module using a standard DB-25 cable. One end of the cable will plug into the DB-25 connector on the PRN printer and the other end plugs into the parallel connector on the N-ANN-S/PG module. Note that the 9-pin DB-9 port on the N-ANN-S/PG is used to connect a serial printer. The 25-pin port is used for a Centronics parallel printer cable. Connect either a serial or parallel printer, but not both at the same time.

Setting Printer Options

Refer to the documentation supplied with the PRN-6 printer for instructions on using the printer menu controls. Set the printer options (under the menu area) as shown in the following table:

Option	Setting	Option	Setting
Font	HS Draft	CPI	10CPI
LPI	6 LPI	Skip	0.5
ESC Character	ESC	Emulate	Epson FX-850
Bidirectional Copy	ON	I/O	
CG-TAB	Graphic	Buffer	40K
Country	E-US ASCII	Serial	
Auto CR	OFF	Baud	9600 or 2400
Color Option	Not Installed	Format	7 Bit, Even, 1 Stop
Formien		Protocol	XON/XOFF
Lines	6LPI=60	Character Set	Standard
Standard	Exec 10.5	Sl.Zero	On
		Auto LF	On
		PAPER	
		BIN 1	12/72"
		BIN 2	12/72"
		SINGLE	12/72"
		PUSH TRA	12/72"
		PULL TRA	12/72"
		PAP ROLL	12/72"

Table 2.2 PRN-6 Setup Options

N-ANN-I/O LED Driver Module

■ N-ANN-I/O Board Layout

Figure 2.22 illustrates the N-ANN-I/O board showing locations of screw terminals for connection to the FACP, pin connectors for connecting LEDs and the DIP switch for selecting the ANN-BUS ID number.

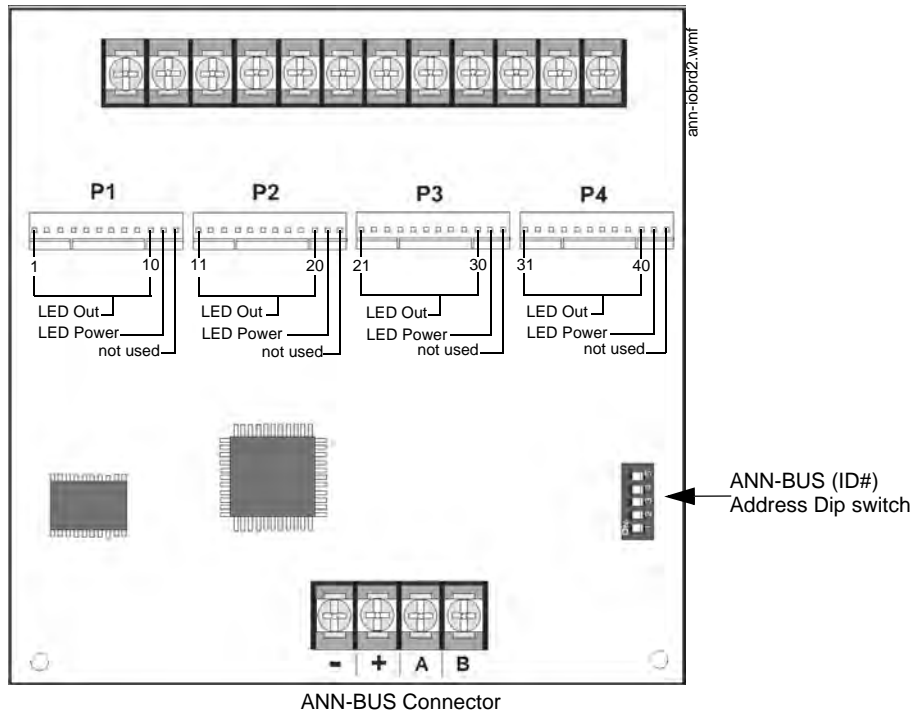

Figure 2.22 ANN-I/O Board Layout

■ Specifications

- Max. ANN-BUS Voltage: 24 VDC
- Max. Current:
 - ✓ Alarm: 200 mA
 - ✓ Standby: 35 mA
 - ✓ Each LED: 10 mA
- Operating Temperature: 32°F to 120°F (0°C to 49°C)
- For indoor use in a dry location only

■ N-ANN-I/O Connection to FACP

The N-ANN-I/O connects to the FACP via the ANN-BUS as illustrated in Figure 2.23. After the N-ANN-I/O is connected to the panel, it must be added to the system via FACP programming. Refer to the section titled “ANN-I/O Options” on page 87.

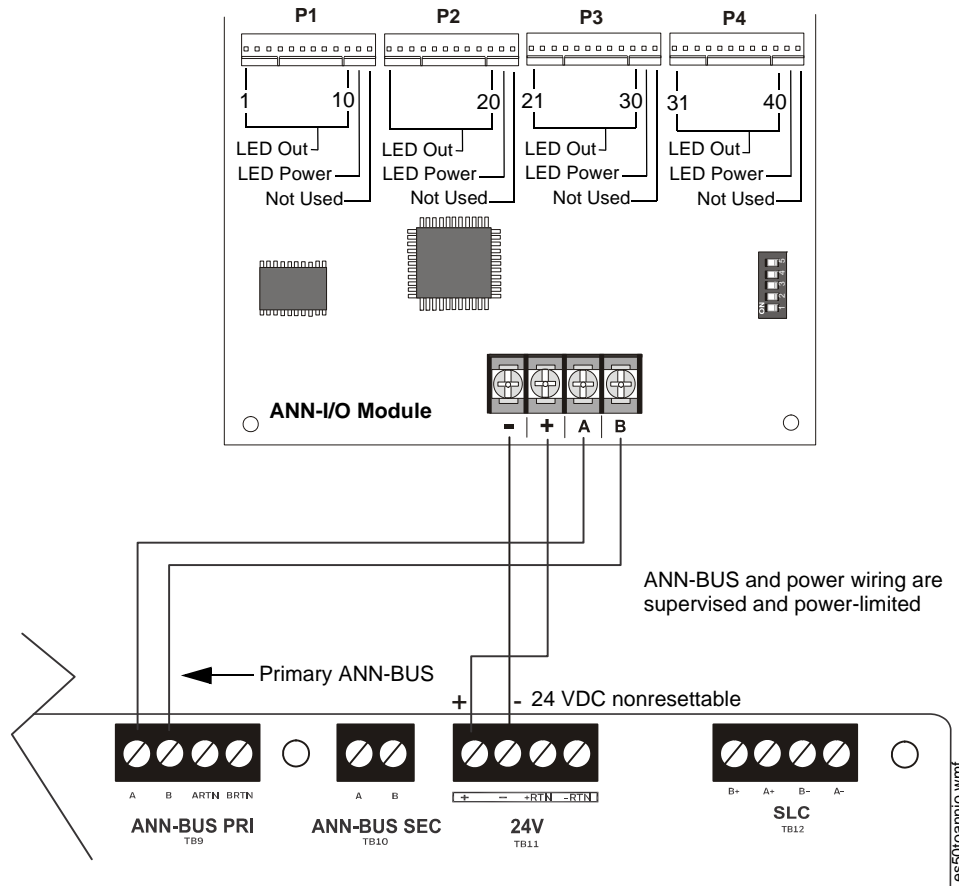
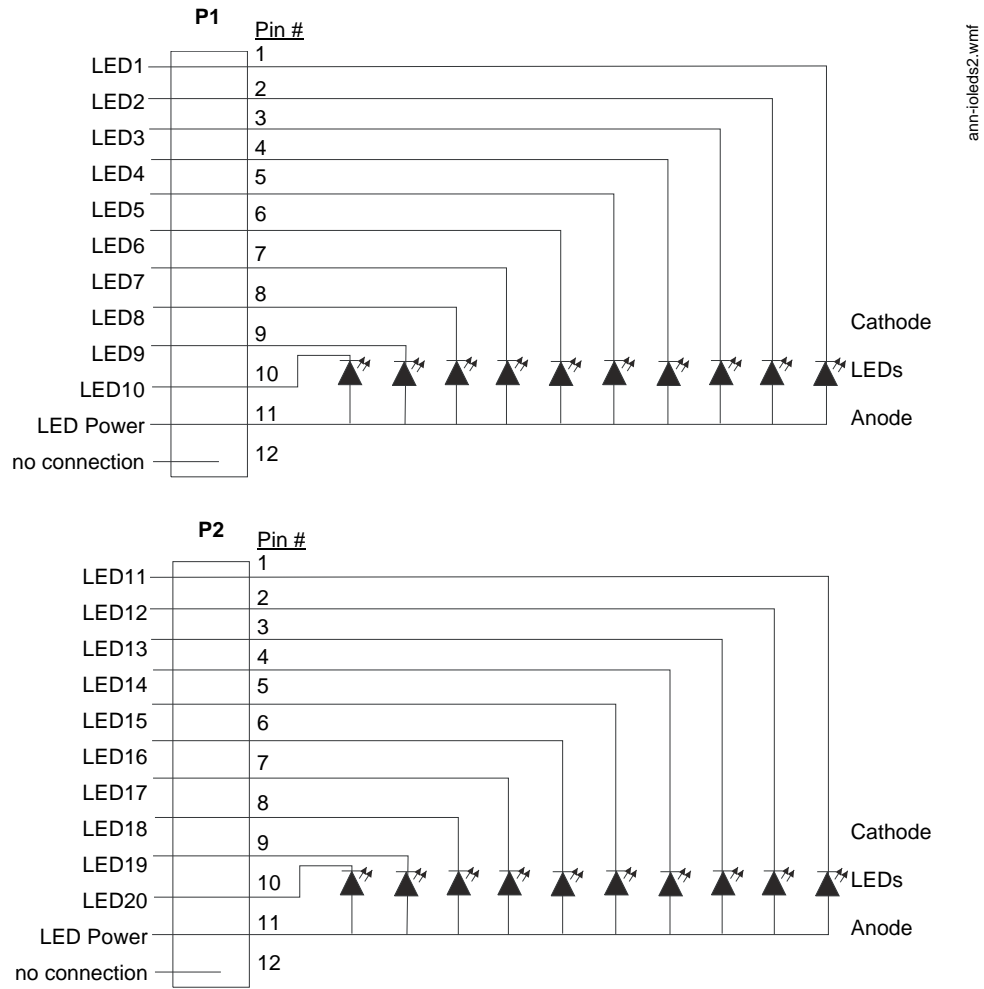

Figure 2.23 ANN-I/O Connection to FACP

■ N-ANN-I/O Module LED Wiring

There are four 12-pin connectors on the N-ANN-I/O module for connecting LEDs. Each set of 10 LEDs get their power from Pin 11 of the corresponding connector. Internal resistors are sized so that there is approximately 10 mA of current for each LED. No series resistors are required. LED outputs can be mapped to output circuits. Refer to the programming section titled “ANN-I/O Options” on page 87 of this manual.

The LEDs are wired as illustrated in Figure 2.24. Note that the illustration depicts only connectors P1 and P2. Wiring is identical for P3 (LEDs 21-30) and P4 (LEDs 31-40).



ann-ioleds2.wmf

Figure 2.24 ANN-I/O LED Wiring

N-ANN-LED Annunciator Module

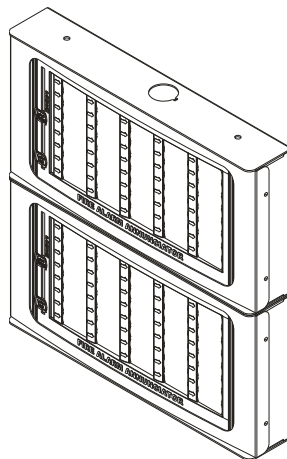

ann-ledstacked.wmf

Figure 2.25 N-ANN-LEDs (shown in possible stacked configuration)

■ **Specifications**

- Max. ANN-BUS Voltage: 24 VDC
- Max. Current:
 - ✓ Alarm: 68 mA
 - ✓ Standby: 28 mA
- Operating Temperature: 32°F to 120°F (0°C to 49°C)
- For indoor use in a dry location only

■ **Mounting/Installation**

The N-ANN-LED Module is supplied with a metal backbox, mounting bracket, and cover. Refer to the *N-ANN-LED Installation Document #53317* for more information.

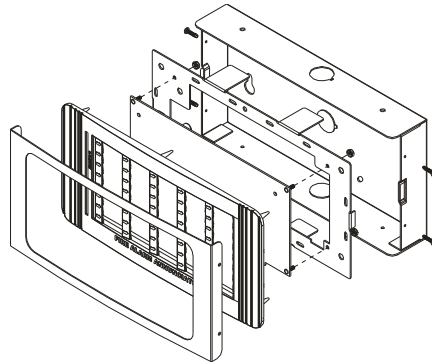

ann-led.wmf

Figure 2.26 Exploded View of N-ANN-LED

■ **N-ANN-LED Board Layout and Connection to FACP**

Figure 2.27 illustrates the N-ANN-LED board showing locations of screw terminals for connection to the FACP and the DIP switches for selecting the ANN-BUS ID number.

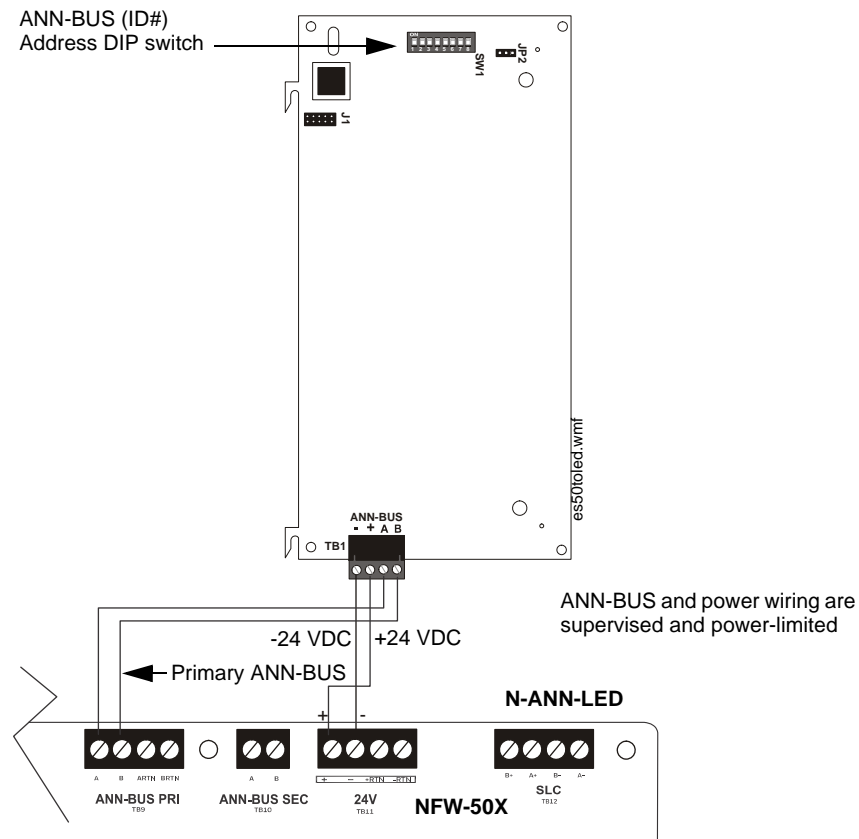

Figure 2.27 N-ANN-LED Board Layout and Connection to FACP

N-ANN-RLY Annunciator Module

■ Specifications

- Operating Voltage: 24 VDC
- Max. Current:
 - ✓ Alarm: 75 mA
 - ✓ Standby: 15 mA
- Operating Temperature: 32°F to 120°F (0°C to 49°C)
- For indoor use in a dry location only

■ Mounting/Installation

The N-ANN-RLY relay module can be mounted inside the FACP main circuit board chassis or inside the ROME Series enclosure. Refer to the *N-ANN-RLY Installation Document #53318* for instructions on chassis mounting or to the *ROME Series Installation Document #53530* for mounting in the separate backbox.

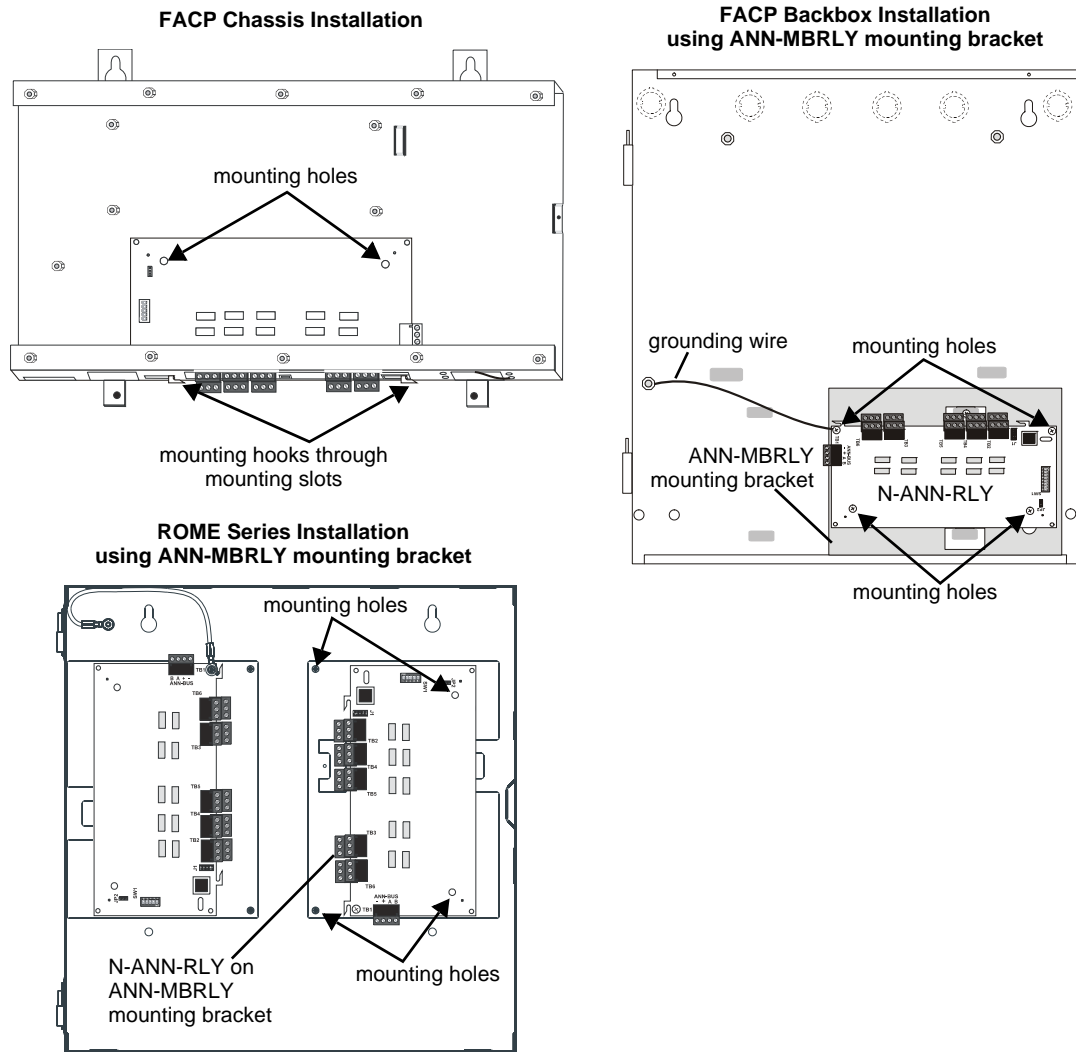

Figure 2.28 N-ANN-RLY Mounting Options

■ N-ANN-RLY Board Layout and Connection to FACP

Figure 2.29 illustrates the N-ANN-RLY board showing locations of screw terminals for connection to the FACP and the DIP switches for selecting the ANN-BUS ID number.

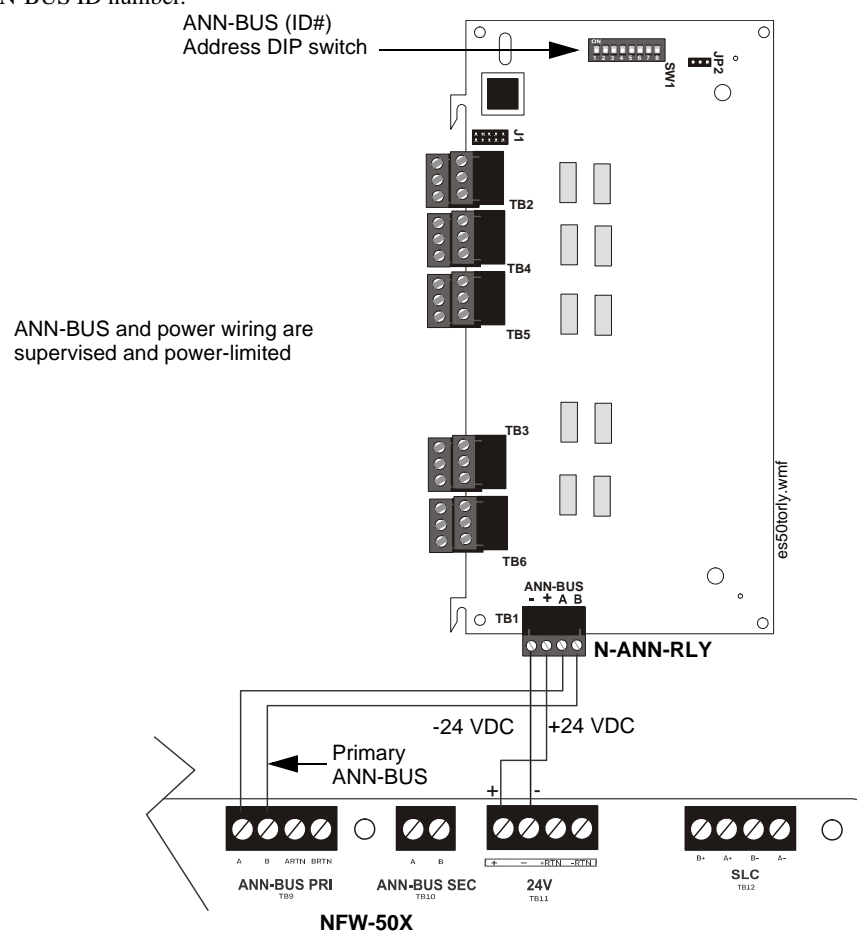

Figure 2.29 N-ANN-RLY Board Layout and Connection to FACP

2.8.4 Printer

A parallel printer may be connected to the FACP using the optional ANN-S/PG Serial/Parallel Interface Module. The printer can be used to provide a hard-copy printout of real-time events, history file and walktest data. Installation of the device requires panel programming to allow the FACP to communicate with the device. Refer to “N-ANN-S/PG Serial/Parallel Interface Module” on page 18 for installation details. Refer to “ANN-BUS Setup” on page 86 for programming information.



CAUTION: POSSIBLE EQUIPMENT DAMAGE

DO NOT CONNECT A PRINTER OR PC TO THE NFW-50X FACP IF A GROUND FAULT (ZERO IMPEDANCE TO GROUND) EXISTS ON THE CONTROL PANEL. CIRCUIT DAMAGE MAY RESULT. REMOVE ALL POWER (PRIMARY AND SECONDARY) BEFORE INSTALLING OR REMOVING ANY WIRING.

Printer Configuration

Refer to the documentation supplied with the printer for pertinent information about printer setup. Set the printer’s options as listed in the following table:

COMMUNICATION SETUP	
BUFFER:	LARGE
DATA BITS:	7
PARITY:	EVEN
STOP BIT:	1 STOP
BAUD RATE:	2400/4800/9600
AUTOMATIC LINE FEED	NO
AUTOMATIC CARRIAGE RETURN	NO

Table 2.3 Printer Options

2.8.5 FWSG Wireless Gateway

The FWSG connects to the FACP's SLC connection at TB10. The FWSG can be powered by either the SLC or an external 24 VDC power source. Refer to the *SWIFT® Smart Wireless Integrated Fire Technology Manual* for more information.

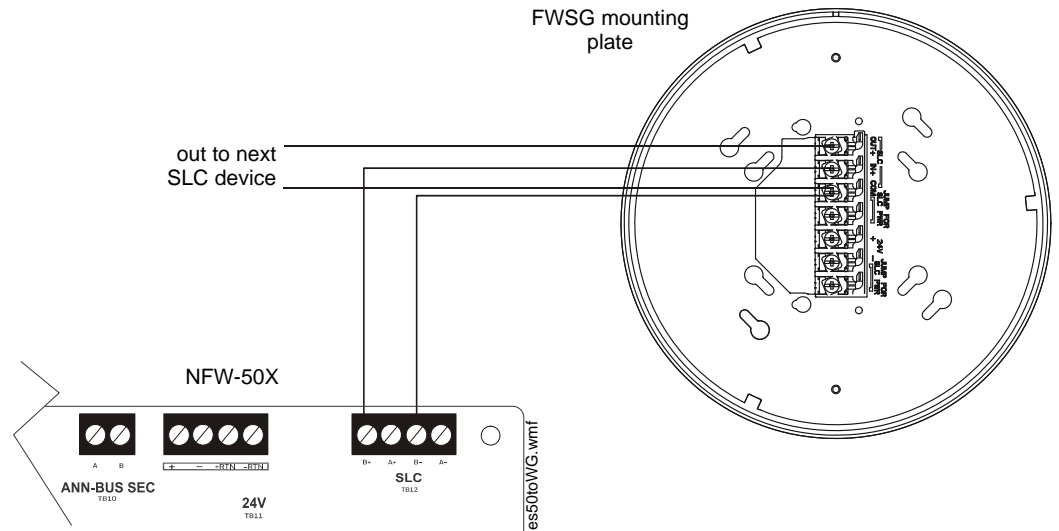

Figure 2.30 FWSG SLC Connection



NOTE: The FWSG, as part of the wireless network, has been tested for compliance with the Federal Communications Commission (FCC) requirements of the United States Government. It has not been evaluated for use outside the USA. Use of this system outside the USA is subject to local laws and rules to which this product may not conform. It is the sole responsibility of the user to determine if this product may be legally used outside the USA.

Section 3: Programming

NOTICE TO USERS, INSTALLERS, AUTHORITIES HAVING JURISDICTION AND OTHER INVOLVED PARTIES			
This product incorporates field-programmable software. In order for the product to comply with the requirements in the Standard for Control Units and Accessories for Fire Alarm Systems, UL 864, certain programming features or options must be limited to specific values or not used at all as indicated below:			
Program feature or option	Permitted in UL864? (Y/N)	Possible settings	Settings permitted in UL864
Trouble Call Limit	N	Refer to "Trouble Report Limit (Dialer Runaway Prevention)" on page 82. <ul style="list-style-type: none"> • Trouble Call Limit = 0 (factory default): unlimited calling to Central Station for any trouble condition • Trouble Call Limit = 1 - 99: limits call for each unique trouble to from 1 to 99 within a 24 hour period 	Trouble Call Limit = 0 for unlimited Central Station trouble calls
AC Fail Delay Timer	Y	Refer to "AC Loss Delay" on page 72. <ul style="list-style-type: none"> • 0-23 hours 	1-3 hours
Remote Download	Y	Refer to "FS-Tools Upload/Download" on page 119. <ul style="list-style-type: none"> • Remote Download - Proprietary No • Remote Download - Proprietary Yes 	Remote Download <i>Proprietary</i> Yes for Proprietary system intended to protect only contiguous properties
Control Module Delay	N	Refer to "Control Module Delay" on page 72. <ul style="list-style-type: none"> • Control Module Delay = 0 (factory default): no delay in Control Module activation • Control Module Delay = 1-180: delays control module activation from 1-180 seconds 	Control Module Delay = 0 for no delay in control module activation
Cellular/Ethernet Supervision Options	Y	Refer to "Supervision Settings" on page 82 and page 82. <ul style="list-style-type: none"> • NFPA 2010 Dual Path: Supervision Interval: 24 Hours • NFPA 2010 Sole Path: Supervision Interval: 5 min • NFPA 2013 Dual Path: Supervision Interval: 6 Hours • NFPA 2013 Sole Path: Supervision Interval: 1 Hour 	Any setting is permitted for UL864.
Trouble Reminder (when used with SWIFT wireless devices)	Y	Refer to "Trouble Reminder" on page 76 <ul style="list-style-type: none"> • 4 hours • 24 hours 	4 hours
4XTM Supervision	Y	Refer to "4XTM Supervision" on page 76. <ul style="list-style-type: none"> • Enabled Yes • Enabled No 	Enabled Yes when the 4XTM module is installed.
Supervised Phone Line	Y	Refer to "Supervised Phone Line" on page 78. <ul style="list-style-type: none"> • Supervised Yes • Supervised No 	Supervised Yes if transmission method is POTS.
Test Time Interval	Y	Refer to "Test Time Interval" on page 81. <ul style="list-style-type: none"> • 24 hours • 12 hours • 8 hours • 6 hours 	6 hours
Annunciator Lock Enable	Y	Refer to "Lock Enable Option" on page 95. <ul style="list-style-type: none"> • Enabled Yes • Enabled No 	Enabled Yes
Canadian Option	N	Refer to "Canadian Option" on page 75. <ul style="list-style-type: none"> • On • Off 	Off

3.1 Programming Data Entry

Programming can be accomplished using the NFW-50X keypad or by connecting an optional standard computer keyboard. The keyboard can be connected to the USB connector J20 on the control panel main circuit board.

The information presented in this section refers to programming the NFW-50X via the onboard keypad. If an optional computer keyboard is connected to the NFW-50X main circuit board, the following table describes the keyboard keys which correspond to the onboard keypad keys.

Keypad Keys	Computer Keyboard Keys
First Event	Home
Last Event	End

Clear	Delete
ESC	Esc
RECALL	Insert
*	*
#	#
@	@
A - Z	A - Z
0 - 9	0 - 9
■ (on YZ key)	Space bar
—	—
/	/
•	•
←	←
→	→
↑	↑
↓	↓
ENTER	Enter
F1	F1
F2	F2
F3	F3
F4	F4
ACK/STEP	F5
SILENCE	F6
DRILL	F7
RESET	F8

3.2 User Programming

The NFW-50X is completely field programmable and requires no special software skills. *While programming the NFW-50X, the fire protection capabilities of the control panel are enabled.*

Site-specific programming may be accomplished in any of the following ways:

- **Autoprogramming Feature** - This is a convenient method for quickly bringing the FACP addressable SLC devices on-line without the necessity of programming each device individually. Refer to “Autoprogram” on page 49 for a detailed description of Autoprogramming.
- Manual programming or editing, using the FACP keypad or a PC keyboard
- Remote Programming and Editing Feature - allows creation and editing of site-specific custom programs using a Windows-based computer and Ethernet connection. For programs requiring a large amount of data entry, this method may be preferred. The FS-Tools programming utility can be downloaded from www.notifier.com for this purpose.
- Local Programming and Editing Feature - allows creation and editing of site-specific custom programs using a Windows-based computer and the FACP USB connection. For programs requiring a large amount of data entry, this method may be preferred. The FS-Tools programming utility can be downloaded from www.notifier.com for this purpose.
- The *System Normal* screen will be displayed in a programmed system with no active alarms, troubles or supervisories, as illustrated below:

SYSTEM NORMAL
10:00A 010118

Read Status mode can be entered while the panel is in any mode of operation. If an alarm or supervisory event exists at the panel, the event must be cleared before entering Programming mode. To access any of the programming or read status features, the *Enter* or *Mode* key must be pressed, which will cause the LCD to display the following:

1=READ STATUS MODE ↓
2=PROGRAMMING MODE
3=FSTOOL UP/DOWNLOAD
4=USB UP/DOWNLOAD

Pressing *I*, while this screen is being displayed, will cause the control panel to enter the Read Status Mode which allows the user to view the programmed features and status of the control panel. The Read Status feature is not password protected. Refer to “Read Status” on page 110 for a detailed description of this feature.

Pressing 2 will select user Programming Mode which may only be accomplished by an authorized person. After pressing 2, a screen will prompt for a password. After entering the correct password, the user may select from a list of programming options.

Pressing 3 will select FS-Tools Up/Download which allows the user to enable the remote programming option. Refer to “FS-Tools Upload/Download” on page 119.

Pressing 4 will select USB Up/Download which allows the user to upload or download FACP programming via the USB port. See “USB Upload/Download” on page 121.

The down arrow which appears in the display indicates that additional programming choices can be viewed by pressing the down arrow key on the keypad. If a down and up arrow appear in the display, pressing the ‘down’ arrow key will display the subsequent Programming Screens as illustrated below while pressing the ‘up’ arrow key will display the previous screen.

Pressing the down arrow displays the following screen:



Pressing 1, while this screen is being displayed, allows the user to upgrade the panel software. Refer to “Firmware Upgrade” on page 123.

Exit Programming and Read Status

The programmer can exit any mode by repeatedly pressing the keypad *ESC* (Escape) key until the display reads System Normal. *Note that the data which is entered during Programming mode is not saved until the programmer exits this mode by repeatedly pressing the ‘ESC’ key. If the Reset key is pressed or power is lost before exiting Programming mode, all data just entered will be lost.*

User Programming Levels

There are two user programming levels:

- User Master Program Level 1 is used for programming panel specific data relating to device types, zoning, messages, control panel functions, etc.
- User Maintenance Program Level 2 is used by a qualified operator to access features such as Disable/Enable, View and Clear History, Walktest, and System Time Change.

3.3 Initial Power-up

The following sections describe the initial programming procedures for a new system. The same procedures are used to modify programming in an existing system.

After completing the wiring of addressable devices to the SLC, apply power to the control panel. If the addressable devices have not yet been programmed into the FACP, their LEDs will not flash and the following trouble message will be displayed.



3.4 Programming Screens Description

The options available when the *Enter* key is pressed are: Read Status, Programming. The Read Status and Programming options have multiple functions or features which may be chosen. To view all of the choices, it is necessary that the programmer scroll through a number of additional *subscreens*. These selections are displayed on multiple screens to make them more readable for the programmer. Refer to “Master Programming Level” on page 49, for additional information on the various screens.

The title of the main option screen will always be displayed at the top of the subscreens for the programmer’s convenience. If additional subscreens exist, an Up or Down arrow will be displayed in the upper right corner of the screen being viewed. The programmer can then press the keypad Up or Down arrow key to view the new subscreen. To select one of the choices in a screen, the programmer presses the keypad numerical key corresponding to the desired choice.

Note that subscreens may also have multiple options which require viewing more than one screen. The same process, as detailed in the previous paragraphs, is followed to view all option choices.

3.5 Programming and Passwords

There are two factory set programming passwords which will access the Programming screens as indicated in the following examples. From either of the screens, access to specific system and device features or programming may be obtained. All user programming entries are stored in nonvolatile memory. The factory set passwords can be changed by the user as described in “Password Change” on page 95. If an invalid password is entered, the blinking cursor will return to the first password character position. To exit Programming or Read Status mode at any time, press the *ESC* (Escape) key repeatedly. Note that Programming mode must be exited using the *ESC* key in order to store the program data entered during this mode. If the *Reset* key is pressed or power is lost before exiting Programming mode, the data just entered will not be saved.

To access user Programming mode, press the *Enter* or *Mode* key. The LCD will display the following.



To enter the user Programming mode, press 2. The display will read as follows:



Entering the Master level password (default 00000000) will cause the following screen to appear:



If the Maintenance level password (default 11111111) is entered, the following screen will appear:



Note that in the two preceding screens, an arrow appears to inform the programmer that additional options can be viewed by pressing the keypad down arrow key.

3.6 Master Programming Level

When the Master Program Level password is entered, the control panel will enter user Programming mode. In this mode, the piezo sounder remains off, the trouble relay is activated and the system Trouble LED flashes until Programming mode is exited. The following display will appear:



Programming Screen #1

Pressing the down arrow will display more programming options:



Programming Screen #2



Programming Screen #3



Programming Screen #4

3.6.1 Autoprogram



Programming Screen #1

Pressing *1* while viewing Programming Screen #1, will select the Autoprogram option, which prompts the control panel to poll all devices installed on the SLC loop. The primary purpose of autoprogramming is to allow the installer a fast and easy way to bring the system on-line as quickly as possible. The first time the system is powered-up, it should be autoprogrammed.

If the system is already programmed and Autoprogram is initiated, the system will only add default values for newly installed devices.

When Autoprogram is selected, the control panel will begin autoprogramming the system by communicating with each addressable device installed on the SLC loop. While autoprogramming, the panel will display the following:



Autoprogram Progress Screen

When Autoprogramming is completed, the control panel will display the type and quantity of each device installed on the SLC loop similar to the following display:

```
# OF DET LOOP1 055
# OF MON LOOP1 035
# OF CON LOOP1 030
```

Autoprogram Result Screen #1

In the preceding example, the display indicates that the SLC Loop has 55 addressable detectors, 35 monitor modules and 30 control modules installed.

Pressing the *ESC* key will return the display to Programming Screen #1.

3.6.2 Point Program

```
PROGRAMMING
1=AUTOPROGRAM
2=POINT PROGRAM
3=ZONE SETUP
```

Programming Screen #1

The Point Program option allows the programmer to add a new addressable device to the SLC loop, delete an existing device from the loop or change the programming for an existing device. Pressing 2, while viewing Programming Screen #1, will select the Point Program option and display the following screens:

```
POINT PROGRAM
SELECT TYPE
1=DETECTOR
2=MODULE
```

Point Program Screen

Detector Programming

Pressing 1, while viewing the Point Program Screen, will allow the programmer to add, delete or change the programming of an addressable detector. The following screen will be displayed by the control panel:

```
DETECTOR
1=ADD
2=DELETE
3=EDIT
```

Detector Screen

■ Add Detector

Pressing 1 while viewing the Detector Screen will display the following screen which allows the programmer to add a new detector address to programming:

```
ADD DETECTOR
ENTER DETECTOR#
***
```

Add Detector Screen

A flashing cursor will appear in the position of the first asterisk to the left. The programmer keys in the three digit detector address, such as 005. The screen will then ask whether the detector being added is wireless.

```
ADD DETECTOR
1=DETECTOR
2=DETECTOR:WIRELESS
```

Add Detector Screen

Select 1 for wired detector or 2 for wireless detector. When the choice is selected, the following screen will be displayed:

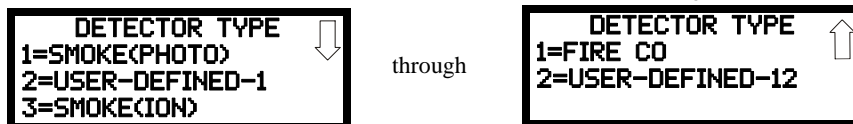

Press the down arrow key to view additional choices. Press the number corresponding to the desired selection to program that type to the newly added detector. If the selected detector is a multi-criteria Fire (Photo)/CO detector, select 1 for *Fire CO*. When the type has been selected, the following screen will be displayed:

```
ADD DETECTOR
DETECTOR# 005
IS ADDED
```



NOTE: The system *must* be monitored by a Supervising Station when using carbon monoxide detection per The Requirements for the Installation of Carbon Monoxide (CO) Detection and Warning Equipment, NFPA 720.

The programmer can continue adding detectors by pressing the ESC key which will return the display to the Add Detector Screen.

■ Delete Detector

```

DETECTOR
1=ADD
2=DELETE
3=EDIT

```

Detector Screen

Pressing 2 in the Detector Screen will display the Delete Detector Screen which allows the programmer to delete a specific detector:

```

DELETE DETECTOR
ENTER DETECTOR#
***

```

Delete Detector Screen

A flashing cursor will appear in the position of the first asterisk to the left. The programmer keys in the three digit detector address, such as 005. When the last digit is keyed-in, the following screen will be displayed:

```

DELETE DETECTOR
DETECTOR#      005
IS DELETED

```

The programmer can continue deleting detectors by pressing the ESC key which will return the display to the Delete Detector Screen.

■ Edit Detector

The programmer can change a detectors existing or factory default programming by pressing 3 in the Detector Screen. The following screen will be displayed:

```

EDIT DETECTOR
ENTER POINT ADDRESS
***

```

Edit Detector Screen

A flashing cursor will appear in the position of the first asterisk to the left. The programmer keys in the three digit detector address, such as 017.

When the last digit is keyed-in, if the selected address has not been added to programming, a screen showing information about a device that is installed with a lower address, closest to the selected address, will be displayed.

If no detectors have been installed on the loop, the following will be displayed:

```

NO DETECTOR
INSTALLED

```

Edit Detector Screen #1

If the selected address has been added to programming, device summary screens will be displayed. These screens allow the programmer to view all device settings at a single glance. Pressing the left or right arrow keys will allow the programmer to rapidly view the devices at the previous or next address (if installed).

If a detector (such as a photoelectric detector) with the selected address is not physically installed on the SLC or has a communication fault but the address is programmed in the system, the following screen will be displayed:

```

TROUBL SMOKE<PHOTO>
<ADJ><NOUN>
          ZNNN
          *  1D017

```

Edit Detector Screen #1

If the selected address has been added to programming and a detector (such as a photoelectric detector) with the selected address is physically installed on the SLC and is communicating with the control panel, the following will be displayed:

```

NORMAL SMOKE <PHOTO>
<ADJ><NOUN>
          ZNNN
          *V * 1D017

```

Edit Detector Screen #1

To change the programming for the displayed detector, press the keyboard 'down' arrow key to view the Edit Detector screens.

In the preceding example:

- ✓ Normal - indicates that the detector with the selected address is physically installed on the SLC and communicating with the control panel (enabled)
- ✓ <ADJ><NOUN> - represents the adjective and noun, which have been programmed, describing the location of the displayed device
- ✓ ZNNN - represents the first of five possible software zones that the detector is assigned to (NNN = the three digit zone number from 000 - 049)
- ✓ V or * - indicates whether or not alarm verification is enabled (V = alarm verification enabled and * = alarm verification disabled)
- ✓ W or * - indicates whether or not walktest is enabled (W = walktest enabled and * = walktest disabled)
- ✓ X or * - indicates whether or not the detector is wireless (X = wireless detector and * = wired detector)
- ✓ ID017 - represents the Loop, Device type and Device address (I=SLC Loop, D=Detector and 017=Detector Address 017)

The following examples show the editing of a photoelectric smoke detector with address 017, located on the SLC loop:

EDIT DETECTOR 1D017

1=ENABLED YES

2=TYPE SMOKE<PHOTO>

3=VERIFICATION OFF

EDIT DETECTOR 1D017

1=WALKTEST YES

2=PAS NO

3=PRE-SIGNAL NO

EDIT DETECTOR 1D017

1=ZONE ASSIGNMENT

000 *** **

EDIT DETECTOR 1D017

WIRELESS NO

2=SOUNDER BASE

EDIT DETECTOR 1D017

1=NOUN/ADJECTIVE

2=DESCRIPTION

Enable/Disable Detector

EDIT DETECTOR

1=ENABLED

2=TYPE

3=VERIFICATION

Edit Detector Screen #2

To Enable or Disable the detector, press the 1 key while viewing the Edit Detector Screen #2. Each press of the key will toggle the screen between *Enabled Yes* and *Enabled No*. If *Enabled No* is selected, the detector will not be polled by the control panel, preventing the detector from reporting alarms and troubles to the panel. The control panel will display the device type and address which has been disabled and will turn on the Trouble LED and Disable LED.

Type

EDIT DETECTOR

1=ENABLED

2=TYPE

3=VERIFICATION

Edit Detector Screen #2

To select the type of detector being programmed, press the 2 key while viewing the Edit Detector Screen #2. This will cause the control panel to display the following Detector Type Screens:

DETECTOR TYPE

1=SMOKE<PHOTO>

2=USER-DEFINED-1

3=SMOKE<ION>

through

DETECTOR TYPE

1=FIRE CO

2=USER-DEFINED-12

Pressing the down arrow key will display additional detector types as indicated in the following table.

Detector Type	Action When Activated
Smoke Photo	Fire Alarm
User-Defined-1	same as previous (Smoke Photo)
Smoke (Ion)	Fire Alarm
User-Defined-2	same as previous (Smoke Ion)
Heat Detect	Fire Alarm
User-Defined-3	same as previous (Heat Detect)
Smoke Duct-P	Fire Alarm
User-Defined-4	same as previous (Smoke Duct-P)
Photo w/Heat	Fire Alarm
User-Defined-5	same as previous (Photo w/Heat)
Duct Superv	Supervisory, latching
User-Defined-7	same as previous (Duct Superv)
Photo Super AR	Supervisory, nonlatching (works only in LiteSpeed)
User-Defined-8	same as previous (Photo Super AR)
ADAPT	Fire Alarm
User-Defined-10	same as previous (ADAPT)
Fire/CO	response is programmable (Alarm, Supv, or None)
User-Defined-12	same as previous (Fire/CO)

While viewing either Detector Type screen, select the type of detector being programmed by pressing the corresponding keyboard number key. The display will return to Edit Detector Screen #2 and indicate the selection next to the Type option.



NOTE: If a detector is selected to be a DUCT SUPERV type, it will function like a supervisory point not a fire alarm point. The supervisory LED and supervisory relay will activate, not the fire alarm LED or alarm relay, if the detector senses smoke.

If the selected detector is a multi-criteria Fire/CO detector, select 1 for *Fire CO* on the last screen and the following will display:

DETECTOR RESPONSE	
1=CO	ALARM
2=HEAT	ALARM
3=PHOTO	ALARM

In this screen, select the action performed by the detector when it is activated. Press 1 to change the response for the *Photo* element of the detector, 2 for the *Heat* element, and 3 for the *CO* element. The detector response will toggle between *Alarm* (sends an Alarm signal to the FACP), *Supervisory* (sends a Supervisory signal to the FACP, and *None* (no signal sent to the FACP).

Verification

EDIT DETECTOR
1=ENABLED
2=TYPE
3=VERIFICATION

Edit Detector Screen #2

Alarm verification is used to confirm that a smoke detector activation is a true alarm condition and not a false alarm. This feature is selected by pressing 3 while viewing the Edit Detector Screen #2 so that the display reads *Verification On*. Each time the 3 key is pressed, the display will toggle between *Verification On* and *Verification Off*. For a detailed description, refer to “Alarm Verification (None or One Minute)” on page 109.

Walktest

EDIT DETECTOR
1=WALKTEST
2=PAS
3=PRE-SIGNAL

Edit Detector Screen #3

The Walktest feature allows one person to test the system devices without the necessity of manually resetting the control panel after each device activation. To enable a device for the Walktest feature, press 1 while viewing the Edit Detector Screen #3 until the display reads *Walktest Yes*. Each press of the 1 key will cause the display to toggle between *Walktest Yes* and *Walktest No*. Refer to “Walktest” on page 109.

PAS

The PAS (Positive Alarm Sequence) option will program an automatic, addressable detector to delay panel activation (including alarm relay and communicator) for a period of 15 seconds plus a programmable time of up to 3 minutes. Zone 047, however, will activate immediately and may be used to connect a signaling device to indicate PAS activation (*do not use a Notification Appliance Circuit for this purpose*). To enable the PAS feature, press 2 while viewing the Edit Detector Screen #3 until the display reads *PAS Yes*. Each press of the 2 key will cause the display to toggle between *PAS Yes* and *PAS No*. Refer to “Positive Alarm Sequence” on page 108.

For example, if a detector with address 005 is to be configured for PAS operation:

- ✓ Select *PAS Yes* when editing the detector set to address 005
- ✓ Program the desired zone or zones to be activated by this detector, in this example Z001
- ✓ Program an output, such as a control module that is to be activated by detector 005 by assigning the same zone to it; in this example Z001
- ✓ Program an output, such as a control module, for PAS activation by assigning zone Z047 to it. This control module may be connected to a signaling device used to indicate a PAS condition (*do not use a Notification Appliance Circuit for this purpose*)
- ✓ Enable zones Z001 and Special Purpose Zone PAS 047 and set the PAS delay timer to some value

With the preceding program settings, when the detector with address 005 is activated, zone Z047 will cause its associated control module to activate immediately, sounding the connected PAS signaling device. Following the PAS delay time, zone Z001 will cause its associated control module to activate and the control panel will initiate an alarm condition.

Note that a detector can be enabled for either PAS or Pre-signal but not both.

Pre-signal

EDIT DETECTOR
1=WALKTEST
2=PAS
3=PRE-SIGNAL

Edit Detector Screen #3

The Pre-signal option programs the detector to delay panel activation for a preprogrammed time delay of up to three minutes while allowing for visual verification by a person. Note that the alarm relay and communicator will respond to the initial alarm immediately. In addition, Zone 18 will activate. This zone can be programmed to a control module which may be used to activate a sounder or indicator which the installer designates as a Presignal indication (*do not use a Notification Appliance Circuit for this purpose*). To

enable the Pre-signal feature, press 3 while viewing Edit Detector Screen #3 until the display reads *Pre-signal Yes*. Each press of the 3 key will cause the display to toggle between *Pre-signal Yes* and *Pre-signal No*. Refer to “Presignal” on page 108.

For example, if a detector with address 005 is to be configured for Pre-Signal operation:

- ✓ Select *Pre-signal Yes* when editing the detector set to address 005
- ✓ Program the desired zone or zones to be activated by this detector, in this example Z001
- ✓ Program an output, such as a control module that is to be activated by detector 005 by assigning the same zone to it; in this example Z001
- ✓ Program an output, such as a control module, for Pre-signal activation by assigning zone Z048 to it. This control module may be connected to a signaling device used to indicate a Pre-signal condition (*do not use a Notification Appliance Circuit for this purpose*)
- ✓ Enable zones Z001 and Special Purpose Zone Pre-signal 048 and set the Pre-signal delay timer to some value

With the preceding program settings, when the detector with address 005 is activated, zone Z048 will cause its associated control module to activate immediately, sounding the connected signaling device to indicate the Pre-signal condition. Following the Pre-signal delay time, zone Z001 will cause its associated control module to activate and the control panel will initiate an alarm condition.

Note that a detector can be enabled for either PAS or Pre-signal, but not both.

Zone Assignment

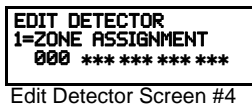

A maximum of five zones can be programmed to each addressable detector. Pressing 1 while viewing Edit Detector Screen #4 displays the following screen:



Zone Assignment Screen

Note that Z*** represents the Zone Number(s) corresponding to this device. The factory default for an unprogrammed device is Z000 for general alarm zone. A flashing cursor will appear on the first 0 to the right. Enter the three digit number corresponding to the zone that is to be assigned to this device. The cursor moves to the next Z*** designation. Continue entering zone assignments or the remaining zones can be left blank or programmed as general alarm zone Z000. When all desired changes have been made, press the Enter key to store the zone assignments. The display will return to the Edit Detector Screen #4. Note that the left and right arrow keys can be used to navigate through the zones and the CLEAR key can be used to quickly clear a zone.

If the selected detector is a multi-criteria detector, the following screen will display respectively before the Zone Assignment Screen allowing the user to program the zones independently.



Multi-Criteria Detector Zones Screen

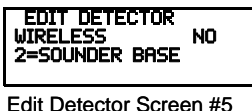

Wireless

The Wireless selection will update automatically if the system recognizes a wireless device. A wireless device operates as part of the SWIFT® wireless network. If the detector is wireless, the display reads *Wireless Yes*. If the device is wired, the display will read *Wireless No*. For more information on the SWIFT wireless network, refer to the SWIFT manual, #LS10036-000NF-E.

Sounder Base

The Sounder Base selection allows the programmer to enter different values if the selected detector is mounted in an addressable sounder base. Pressing 2 while viewing Edit Detector Screen #5 will display the following:

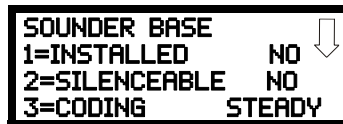

Sounder Base Screen #1



Sounder Base Screen #2

If the selected detector has been installed in a sounder base, press 1 while viewing Sounder Base Screen #1 until the display reads *Installed Yes*. Each press of the 1 key will cause the display to toggle between *Installed Yes* and *Installed No*.

The Silenceable selection allows the programmer to select whether the selected sounder base can be silenced, either by pressing the Alarm Silence key or by enabling Autosilence. Pressing the 2 key while viewing Sounder Base Screen #1 will enable the Silenceable feature causing the display to read *Silenceable Yes*. Repeated presses of the 2 key will cause the display to toggle between *Silenceable Yes* and *Silenceable No*.

The Fire Coding feature allows the programmer to select the type of output that the sounder base will generate when activated. Pressing 3 while viewing Sounder Base Screen #1 will cause the following displays to appear:



Coding Screen #1

The programmer can select the sounder base output by pressing the number corresponding to the desired output. The coding selections are:

- Steady - a continuous output with no coding
- Temporal 3 - ½ Second On, ½ Second Off, ½ Second On, ½ Second Off, ½ Second On, 1½ Seconds Off
- Temporal 4 - ½ Second On, ½ Second Off, ½ Second On, ½ Second Off, ½ Second On, ½ Second Off, ½ Second On, 1½ Seconds Off

```

SOUNDER BASE
1=ZONE ASSIGNMENT
*** ** * ** * ** *
2=VOLUME          LOW
    
```

Sounder Base Screen #2

The sounder base volume has two settings: Low, or High. Press *1* while viewing Sounder Base Screen #2 until the display reads Low or High as desired. Each press of the *1* key will cause the display to toggle between *Volume Low* and *Volume High*.

A maximum of five zones can be programmed to each sounder base. Pressing *2* while viewing Sounder Base Screen #2 displays the following screen:

```

ZONE ASSIGNMENT
Z*** Z*** Z*** Z***
    
```

Zone Assignment Screen

Note that Z*** represents the Zone Number(s) corresponding to this device. The factory default for an unprogrammed device is Z000 for general alarm zone. A flashing cursor will appear on the first *0* to the left. Enter the three digit number corresponding to the zone that is to be assigned to this sounder base. The cursor moves to the next Z*** designation. Continue entering zone assignments or the remaining zones can be left blank or programmed as general alarm zone Z000. When all desired changes have been made, press the Enter key to store the zone assignments. The display will return to the Sounder Base Screen #2. Note that the left and right arrow keys can be used to navigate through the zones and the *CLEAR* key can be used to quickly clear a zone.



CAUTION: VERIFY SOUNDER BASE MODEL NUMBER

USE OF THE SOUNDER BASE PROGRAMMING OPTIONS REQUIRES THE USE OF THE **B200S** SOUNDER BASE. WHILE THE **B200SR** SOUNDER BASE IS COMPATIBLE, IT DOES NOT ALLOW FOR SPECIAL PROGRAMMING OPTIONS. IF USING THE B200SR, SET THE SOUNDER BASE OPTION TO "NO". IF SET TO "YES", AN ERROR WILL OCCUR AND THE SYSTEM WILL DISPLAY AN INVALID REPLY. CODING OPTIONS FOR THE B200SR ARE ACHIEVED MANUALLY WITH JUMPER SETTINGS ON THE DEVICE.

Noun/Adjective

```

EDIT DETECTOR
1=NOUN/ADJECTIVE
2=DESCRIPTION
*****
Edit Detector Screen #6
    
```

The Noun/Adjective selection allows the programmer to enter specific descriptors about the detector currently being programmed. Pressing *1* while viewing Edit Detector Screen #6 will cause the following screen to be displayed:

```

1=STANDARD ADJECTIVE
2=STANDARD NOUN
3=CUSTOM ADJECTIVE
4=CUSTOM NOUN
    
```

Noun/Adjective Screen

```

1=STANDARD ADJECTIVE
2=STANDARD NOUN
3=CUSTOM ADJECTIVE
4=CUSTOM NOUN
Noun/Adjective Screen
    
```

Pressing *1* while viewing the Noun/Adjective Screen will cause the following screen(s) to be displayed. Note that the keyboard *down* arrow key must be pressed to see all the Adjective screens. Press the number corresponding to the adjective that is to be used as a descriptor for the location of the detector currently being programmed. When an adjective has been selected, it will appear at the top of the display as indicated by the asterisks.

```

*****
1=NORTH
2=SOUTH
3=EAST
    
```

Adjective Screen #1

```

*****
1=WEST
2=FRONT
3=CENTER
    
```

Adjective Screen #2

```

*****
1=REAR
2=UPPER
3=LOWER
    
```

Adjective Screen #3

```

*****
1=MAIN
2=FIRST
3=2ND
    
```

Adjective Screen #4

```

*****
1=3RD
2=4TH
3=5TH
    
```

Adjective Screen #5

```

*****
1=FLOOR1
2=FLOOR2
3=FLOOR3
    
```

Adjective Screen #6

```

*****
1=FLOOR5
2=FLOOR6
3=ROOM
    
```

Adjective Screen #7

```

1=STANDARD ADJECTIVE
2=STANDARD NOUN
3=CUSTOM ADJECTIVE
4=CUSTOM NOUN
Noun/Adjective Screen
    
```

Pressing *2* while viewing the Noun/Adjective Screen will cause the following screen(s) to be displayed. Note that the keyboard *down* arrow key must be pressed to see all the Noun screens. Press the number corresponding to the noun that is to be used as a descriptor for the location of the detector currently being programmed. When a noun has been selected, it will appear at the top of the display as indicated by the asterisks.

***** 1=BASEMENT 2=BOILER RM 3=CLASSROOM ↓	***** 1=CLOSET 2=CORRIDOR 3=ELECTRIC RM ↑↓	***** 1=ELEVATOR 2=ENTRANCE 3=FLOOR ↑↓	***** 1=GARAGE 2=HALLWAY 3=HVAC RM ↑↓
Noun Screen #1	Noun Screen #2	Noun Screen #3	Noun Screen #4
***** 1=KITCHEN 2=LOBBY 3=OFFICE ↑↓	***** 1=PATIENT 2=RESTROOM 3=ROOM ↑↓	***** 1=STAIRWAY 2=STOREROOM 3=WING ↑↓	***** 1=ZONE ↑
Noun Screen #5	Noun Screen #6	Noun Screen #7	Noun Screen #8

1=STANDARD ADJECTIVE
 2=STANDARD NOUN
 3=CUSTOM ADJECTIVE
 4=CUSTOM NOUN
 Noun/Adjective Screen

Pressing 3 or 4 while viewing the Noun/Adjective Screen will display screens similar to the previous Adjective and Noun Screens. The new screens will list custom Adjectives and Nouns which have been programmed into the control panel using the FS-Tools utility. These descriptors are selected as described in the previous sections.

Description

EDIT DETECTOR
 1=NOUN/ADJECTIVE
 2=DESCRIPTION
 Edit Detector Screen #5

The Description selection allows the programmer to enter additional information about the detector currently being programmed. This information will be displayed as part of the device label on the display. Pressing 2 while viewing Edit Detector Screen #5 will cause the following screen to be displayed:

DESCRIPTION 1D002
 NOUN-ADJECTIVE

 |

Adjective/Noun Screen

A flashing cursor will appear at the first asterisk to the left. The programmer can enter additional descriptive information about the device being programmed. This information will appear on the display along with the standard device label information. A maximum of 20 characters (including spaces) can be entered. To enter alphanumeric characters from the keypad, repeatedly press the appropriate key until the desired character is displayed in the first position. For example, to enter the letter *B*, press the 2 (ABC) key three times to toggle through the characters 2, A and B. Press the right arrow key to move the cursor one position to the right and repeat the process to enter the next character. To enter a space, press the * (QZ) key four times until a blank appears in the desired position. When all characters have been entered, press the Enter key to store the information. The display will return to the Edit Detector Screen #5, displaying the new information at the bottom of the screen.

Recall/Increment Function

In addition, the user may use the Recall/Increment function at any time when the cursor is on the first letter of the Description, Adjective or Noun field as follows:

- If the zero key is pressed, a 0 is placed in the first letter position
- If the zero key is then pressed a second time with no intervening key actions, the entire field is replaced with the field entered *for the previous device programmed*, and the cursor moves to the last character of the field (Recall function). The Recalled Adjective or Noun field may now be changed letter-by-letter
- If the zero key is pressed again with no other intervening key actions and the last character in the field is a number 0-9, the number is incremented by one. If the last character is a letter, it changes to a 0. If the last character is 9 it goes to 0
- The above increment function may be repeated with each press of the zero key

As an example, the user could quickly enter 'FLR_3_ROOM_305' as follows:

1. The cursor is on the first letter of the Adjective field. Press the zero key twice to display *FLR_3*
2. With the cursor on the first letter of the Noun field, press the zero key twice to recall the display *ROOM_304*. The cursor automatically jumps from the first to the last letter of the Noun field
3. With the cursor on the last letter of the Noun field, press the zero key again to increment the room number to 305
4. Press the right arrow key to advance the zone field
5. Select a zone number from 000 to 049. Z000 (default zone) is the general alarm zone. Z001 through Z049 may be selected to link software zones

Module Programming

POINT PROGRAM
 SELECT TYPE
 1=DETECTOR
 2=MODULE
 Point Program Screen #2

Pressing 2, while viewing Point Program Screen #2, will allow the programmer to add, delete or change the programming of an addressable module. The following screen will be displayed by the control panel:

MODULES
 1=ADD
 2=DELETE
 3=EDIT
 Modules Screen

■ Add Module

Pressing 1 while viewing the Modules Screen will display the following screen which allows the programmer to add a new module address to programming:

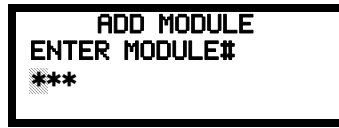

Add Module Screen #1

A flashing cursor will appear in the position of the first asterisk to the left. The programmer keys in the three digit module address, such as 005.

When the last digit is keyed-in, the following screen will be displayed:

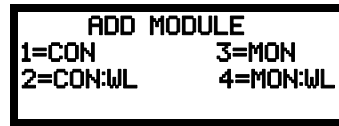

Add Module Screen #2

Pressing 1 for Control Module, 2 for Wireless Control Module, 3 for Monitor Module, or 4 for Wireless Monitor Module will cause the following screen to be displayed:

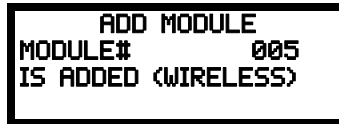

Add Module Screen #3

The programmer can continue adding modules by pressing the ESC or left arrow key which will return the display to the Add Module Screen #1.

■ Delete Module



Modules Screen

Pressing 2 in the Modules Screen will display the Delete Module Screen which allows the programmer to delete a specific module:



Delete Module Screen

A flashing cursor will appear in the position of the first asterisk to the left. Using the panel keypad, key in the module address such as 005. When the last digit is keyed in, the following confirmation that the module has been deleted will be displayed:



■ Edit Module Screen for Monitor Module

The programmer can change a modules existing or factory default programming by pressing 3 in the Modules Screen. The following screen will be displayed:

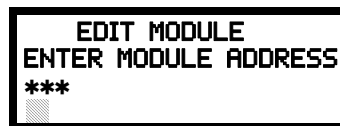

Edit Module Screen

A flashing cursor will appear in the position of the first asterisk to the left. The programmer keys in the three digit module address, such as 012. When the last digit is keyed-in, if the selected address has *not* been added to programming, a screen showing information about a device that is installed with a lower address, closest to the selected address, will be displayed. If no modules are installed on the loop, the following screen will be displayed:



Edit Module Screen

If the selected address has been added to programming but a module (such as a monitor module) with the selected address is not physically installed on the SLC or has a communication fault, the following screen will be displayed:



If the selected address has been added to programming and a module (such as a monitor module) with the selected address is physically installed on the SLC and is communicating with the control panel, the following screen will be displayed:



To change the programming for the displayed module, press the keyboard down arrow key to view the following Edit Monitor screens. In the preceding example:

- ✓ Normal - indicates that the module with the selected address is physically installed on the SLC and communicating with the control panel (enabled)
- ✓ <ADJ><NOUN> - represents the adjective and noun, which have been programmed, describing the location of the displayed device
- ✓ ZNNN - represents the first of five possible software zones that the module is assigned to (NNN = the three digit zone number from 000 - 049)
- ✓ 1M012 - represents the Loop, Device type and Device address (1 = SLC Loop, M = Module and 012 = Module Address 012)
- ✓ W or * - indicates whether or not the device is programmed for Walktest (W = programmed for walktest, * = not programmed for walktest).
- ✓ X or * - indicates whether or not the device is wireless (X = wireless, * = wired).

If the selected address corresponds to a control module, a screen displaying information about the control module with the selected address will be displayed as shown in “Edit Module Screen for Control Modules” on page 62.

If the selected address corresponds to a monitor module, a screen displaying information about the module with the selected address will be displayed as illustrated in the following:



Edit Monitor Screen #2



Edit Monitor Screen #3



Edit Monitor Screen #4



Edit Monitor Screen #5

Enable/Disable Module

To Enable or Disable the monitor module, press the *I* key while viewing the Edit Module Screen #2. Each press of the key will toggle the screen between *Enabled Yes* and *Enabled No*. If *Enabled No* is selected, the module will not be polled by the control panel, preventing the module from reporting alarms and troubles to the panel. The control panel will indicate a system trouble condition and the Disable LED with turn on if any devices are disabled.

Type Monitor



Edit Monitor Screen #2

Using the FS-Tools Upload/Download utility, unique user-defined monitor types can be created and loaded into the FACP for later use. The FACP response to the activation of a user-defined type is the same as most previous standard types in the list, thus allowing a variety of user-defined types and responses. To select the type of monitor module being programmed, press the 2 key while viewing the Edit Monitor Screen #2. This will cause the control panel to display the following Monitor Type Screens:

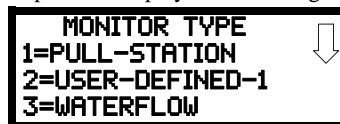

Monitor Type Screen #1

Pressing the down arrow key will display additional Monitor Type screens. While viewing one of the Monitor Type screens, select the type of monitor module being programmed by pressing the corresponding keypad number key. The display will return to the Edit Monitor Screen #2 which will show the new type selection.

Table 3.1 lists the Monitor Types and their respective functions.

Monitor module type selection will affect the function of the point as follows:

Monitor Type	Action When Activated
Pull-Station	Fire Alarm
User-Defined-1	same as previous (Pull-Station)
Waterflow	Fire Alarm Delayed
User-Defined-2	same as previous (Waterflow)
Monitor	Fire Alarm
User-Defined-3	same as previous (Monitor)
Future	not used
Future	not used
Smoke-Conventional	Fire Alarm
User-Defined-5	same as previous (Smoke-Conventional)
Heat Conventional	Fire Alarm
User-Defined-6	same as previous (Heat-Detector)
Medic Alert ¹	General Purpose Signaling, latching
User-Defined-7	same as previous (Medic-Alert)
Hazard Alert ¹	General Purpose Signaling, latching
User-Defined-8	same as previous (Hazard-Alert)
Tornado Alert ¹	General Purpose Signaling, latching
User-Defined-9	same as previous (Tornado-Alert)
Phone	Active Phone (LCD display only)
User-Defined-10	same as previous (Phone)
Tamper	Supervisory, nonlatching (tracking)
User-Defined-11	same as previous (Tamper)
Supervisory	Supervisory, latching
User-Defined-12	same as previous (Supervisory)
Supervisory AR ²	Supervisory, nonlatching (tracking)
User-Defined-13	same as previous (Supervisory-AR)
HVAC OVRRIDE ³	Switch Supervisory, nonlatching (tracking)
Power Monitor	Power Fault
User-Defined-14	same as previous (Power Monitor)
Trouble Monitor	Trouble
User-Defined-15	same as previous (Trouble Monitor)
Process Monitor	General Purpose Signaling, latching
User-Defined 16 ¹	same as previous (Process-Monitor)
Process Monitor AR ^{1,2}	General Purpose Signaling, nonlatching (tracking)
User-Defined-17	same as previous (Process-Monitor-AR)
Future	not used
Future	not used
Ack Switch	Acts like panel Acknowledge Key
Sil Switch	Acts like panel Silence Key
Reset Switch	Acts like panel Reset Key
Drill Switch	Acts like panel Drill Key
PAS Bypass	PAS Disable
HVAC RESTART ³	Switch (see note 2)
Drill Switch AR ²	Acts like panel Drill Key, non-latching (tracking)
Wireless Gateway	SWIFT gateway needs this type to display wireless troubles at the FACP

Table 3.1 Monitor Types

¹ Combination systems employing these non-fire monitor types require the SLC loop to be programmed by the installer for Class B operation and isolator modules must be employed on each non-fire branch of the SLC as shown in the SLC Wiring Manual (document number 52304 and 515253). Fire and non-fire devices must not be used on the same SLC branch. For UL2017 compliance, The N-ANN-LED annunciator must be used to indicate the active, dedicated zone or device

² For entries ending in AR, AR refers to AutoResettable.

³ For HVAC RESTART and HVAC OVRRIDE descriptions, refer to "Monitor Module Operation" on page 141.

Pre-signal

```

EDIT MONITOR
1=PRE-SIGNAL      NO
WIRELESS          NO
    
```

Edit Monitor Screen #3

To enable the Pre-signal feature, press *1* while viewing Edit Monitor Screen #3 until the display reads *Pre-signal Yes*. Each press of the *1* key will cause the display to toggle between *Pre-signal Yes* and *Pre-signal No*. Refer to “Presignal” on page 108 for additional information.

Wireless

```

EDIT MONITOR
1=PRE-SIGNAL      NO
WIRELESS          NO
    
```

Edit Monitor Screen #3

The Wireless selection will update automatically if the system recognizes a wireless device. If the module is wireless, the display reads *Wireless Yes*. If the module is wired, the display will read *Wireless No*. Fore more information on the SWIFT wireless network, refer to the *SWIFT manual*, #LS10036-000NF-E.

Walktest

```

EDIT MONITOR
1=WALKTEST
2=ZONE ASSIGNMENT
000 *** ** *
    
```

Edit Monitor Screen #4

The Walktest feature allows one person to test the system devices without the necessity of manually resetting the control panel after each device activation. To enable devices, which are connected to a monitor module, for the Walktest feature, press *1* while viewing the Edit Monitor Screen #4 until the display reads *Walktest Yes*. Each press of the *1* key will cause the display to toggle between *Walktest Yes* and *Walktest No*. Refer to “Walktest” on page 109 for additional information.

Zone Assignment

A maximum of five zones can be programmed to each addressable monitor module. Pressing *2* while viewing Edit Monitor Screen #4 displays the following screen:

```

ZONE ASSIGNMENT
Z000 Z*** Z*** Z*** Z***
    
```

Zone Assignment Screen

Note that Z*** represents the Zone Number(s) corresponding to this device. The factory default for an unprogrammed device is Z000 for general alarm zone. A flashing cursor will appear on the first *0* to the left. Enter the three digit number corresponding to the zone that is to be assigned to this device. The cursor moves to the next Z*** designation. Continue entering zone assignments or the remaining zones can be left blank or programmed as general alarm zones Z00. When all desired changes have been made, press the Enter key to store the zone assignments. The display will return to the Edit Monitor Screen #4.

Noun/Adjective

```

EDIT MONITOR
1=NOUN/ADJECTIVE
2=DESCRIPTION
*****
    
```

Edit Monitor Screen #5

The Noun/Adjective selection allows the programmer to enter specific descriptors about the monitor module currently being programmed. Pressing *1* while viewing Edit Monitor Screen #5 will cause the following screen to be displayed:

```

1=STANDARD ADJECTIVE
2=STANDARD NOUN
3=CUSTOM ADJECTIVE
4=CUSTOM NOUN
    
```

Noun/Adjective Screen

```

1=STANDARD ADJECTIVE
2=STANDARD NOUN
3=CUSTOM ADJECTIVE
4=CUSTOM NOUN
    
```

Noun/Adjective Screen

Pressing *1* while viewing the Noun/Adjective Screen will cause the following screen(s) to be displayed. Note that the keyboard *down* arrow key must be pressed to see all the Adjective screens. Press the number corresponding to the adjective that is to be used as a descriptor for the location of the monitor module currently being programmed.

```

*****
1=NORTH
2=SOUTH
3=EAST
    
```

Adjective Screen #1

```

*****
1=WEST
2=FRONT
3=CENTER
    
```

Adjective Screen #2

```

*****
1=REAR
2=UPPER
3=LOWER
    
```

Adjective Screen #3

```

*****
1=MAIN
2=FIRST
3=2ND
    
```

Adjective Screen #4

```

*****
1=3RD
2=4TH
3=5TH
    
```

Adjective Screen #5

```

*****
1=FLOOR 1
2=FLOOR 2
3=FLOOR 3
    
```

Adjective Screen #6

```

*****
1=FLOOR 4
2=FLOOR 5
3=ROOM
    
```

Adjective Screen #7

```

1=STANDARD ADJECTIVE
2=STANDARD NOUN
3=CUSTOM ADJECTIVE
4=CUSTOM NOUN
    
```

Noun/Adjective Screen

Pressing 2 while viewing the Noun/Adjective Screen will cause the following screen(s) to be displayed. Note that the keyboard *down* arrow key must be pressed to see all the Noun screens. Press the number corresponding to the noun that is to be used as a descriptor for the location of the monitor module currently being programmed.

```

*****
1=BASEMENT
2=BOILER RM
3=CLASSROOM
    
```

Noun Screen #1

```

*****
1=CLOSET
2=CORRIDOR
3=ELECTRIC RM
    
```

Noun Screen #2

```

*****
1=ELEVATOR
2=ENTRANCE
3=FLOOR
    
```

Noun Screen #3

```

*****
1=GARAGE
2=HALLWAY
3=HVAC RM
    
```

Noun Screen #4

```

*****
1=KITCHEN
2=LOBBY
3=OFFICE
    
```

Noun Screen #5

```

*****
1=PATIENT
2=RESTROOM
3=ROOM
    
```

Noun Screen #6

```

*****
1=STAIRWAY
2=STOREROOM
3=WING
    
```

Noun Screen #7

```

*****
1=ZONE
    
```

Noun Screen #8

Pressing 3 or 4 while viewing the Noun/Adjective Screen will display screens similar to the previous Adjective and Noun Screens. The new screens will list Custom Adjectives and Nouns which have been programmed into the control panel using the FS-Tools utility.

Description

```

EDIT MONITOR
1=NOUN/ADJECTIVE
2=DESCRIPTION
*****
    
```

Edit Monitor Screen #5

The Description selection allows the programmer to enter additional information about the monitor module currently being programmed. This information will be displayed as part of the device label on the LCD display. Pressing 2 while viewing Edit Monitor Screen #5 will cause the following screen to be displayed:

```

DESCRIPTION 1M012
NOUN/ADJECTIVE
*****
    
```

Noun/Adjective Screen

A flashing cursor will appear at the first asterisk to the left. The programmer can enter additional descriptive information about the device being programmed. This information will appear on the LCD display along with the standard device label information.

A maximum of 20 characters (including spaces) can be entered. To enter alphanumeric characters from the keypad, repeatedly press the appropriate key until the desired character is displayed in the first position. For example, to enter the letter *B*, press the 2 (*ABC*) key three times to toggle through the characters 2, *A* and *B*. Press the right arrow key to move the cursor one position to the right and repeat the process to enter the next character. To enter a space, press the * (*OZ*) key four times until a blank appears in the desired position. When all characters have been entered, press the Enter key to store the information. The display will return to the Edit Monitor Screen #4, displaying the new information at the bottom of the screen.

Recall/Increment Function

In addition, the user may use the Recall/Increment function at any time when the cursor is on the first letter of the Adjective or Noun field as follows:

- If the zero key is pressed, a 0 is placed in the first letter position
- If the zero key is then pressed a second time with no intervening key actions, the entire Adjective field is replaced with the field entered *for the previous device programmed*, and the cursor moves to the last character of the field (Recall function). The Recalled Adjective or Noun field may now be changed letter-by-letter
- If the zero key is pressed again with no other intervening key actions and the last character in the field is a number 0-9, the number is incremented by one. If the last character is a letter, it changes to a 0. If the last character is 9 it goes to 0
- The above increment function may be repeated with each press of the zero key

As an example, the user could quickly enter 'FLR_3_ROOM 305' as follows:

1. The cursor is on the first letter of the Adjective field. Press the zero key twice to display *FLR_3*
2. With the cursor on the first letter of the Noun field, press the zero key twice to recall the display *ROOM_304*. The cursor automatically jumps from the first to the last letter of the Noun field
3. With the cursor on the last letter of the Noun field, press the zero key again to increment the room number to *305*
4. Press the right arrow key to advance the zone field
5. Select a zone number from 000 to 049. Z000 (default zone) is the general alarm zone. Z001 through Z049 may be selected to link software zones

Edit Module Screen for Control Modules

```

MODULES
1=ADD
2=DELETE
3=EDIT
    
```

Modules Screen

The programmer can change a module's existing or factory default programming by pressing 3 in the Modules Screen. The following screen will be displayed:

```

EDIT MODULE
ENTER MODULE ADDRESS
***
    
```

Edit Module Screen

A flashing cursor will appear in the position of the first asterisk to the left.

The programmer keys in the three digit module address, such as 002. When the last digit is keyed-in, if the selected address corresponds to a control module, a screen displaying information about the control module with the selected address will be displayed as illustrated in the following:

```

NORMAL CONTROL
<ADJ><NOUN>
ZNNN
* ** 1M002
    
```

Edit Control Screen #1

In the preceding example:

- ✓ Normal - indicates that the module with the selected address is physically installed on the SLC and communicating with the control panel (enabled)
- ✓ ugh.<ADJ><NOUN> - represents the adjective and noun, which have been programmed, describing the location of the displayed device
- ✓ Control - indicates that the selected module is a control module
- ✓ S or * - represents Silenceable (S) or Nonsilenceable (*)
- ✓ W or * - represents Waterflow Timer Delay (W = Waterflow Timer Delay enabled, * = Waterflow Timer Delay disabled)
- ✓ ZNNN - represents the first of five possible software zones that the module is assigned to (NNN = the three digit zone number from 000 - 049)
- ✓ 1M002 - represents the Loop, Device type and Device address (1=SLC Loop, M=Module and 002 = Module Address 02)

To change the programming for the displayed module, press the keyboard *down* arrow key to view the following Edit Control screens:

```

EDIT CONTROL
1=ENABLED YES
2=TYPE CONTROL
3=SILENCEABLE YES
    
```

Edit Control Screen #2

```

EDIT CONTROL
1=WALKTEST YES
2=ZONE ASSIGNMENT
000 *** **
    
```

Edit Control Screen #3

```

EDIT CONTROL
1=NOUN/ADJECTIVE
2=DESCRIPTION
*****
    
```

Edit Control Screen #4

```

EDIT CONTROL
1=CTRL MOD DLY NO
WIRELESS NO
    
```

Edit Control Screen #5

Enable/Disable Module

```

EDIT CONTROL
1=ENABLED
2=TYPE CONTROL
3=SILENCEABLE
    
```

Edit Control Screen #2

To Enable or Disable the control module, press the 1 key while viewing the Edit Control Screen #2. Each press of the key will toggle the screen between *Enabled Yes* and *Enabled No*. If *Enabled No* is selected, the module will not be polled by the control panel, preventing the module from activating its output devices. The control panel will indicate a system trouble condition and the Disable LED will turn on if any devices are disabled.

Control Type

```

EDIT CONTROL
1=ENABLED
2=TYPE CONTROL
3=SILENCEABLE
    
```

Edit Control Screen #2

To select the type of control module being programmed, press the 2 key while viewing the Edit Control Screen #2. This will cause the control panel to display the following Control Type Screens. Press the down arrow key to view additional screens and selections.

```

CONTROL TYPE
FUTURE USE
2=BELL-CIRCUIT
3=HORN-CIRCUIT
    
```

Control Type Screen #1

While viewing one of the Control Type screens, select the type of control module being programmed by pressing the corresponding keypad number key. The display will return to the Edit Control Screen #2 and indicate the new type selection.



NOTE: A control relay module set to the Resettable Power type will follow the main circuit board 24 VDC resettable power unless the control relay module is disabled.

The following table contains control module type codes and their functions which are displayed in the Control Type screens:

Control Type	Special Function
Bell Circuit	NAC Type - supervised
Horn Circuit	NAC Type - supervised
Sounders	NAC Type - supervised
Relay	Ignore Open Circuit
Strobe Circuit	NAC Type - supervised
Control	NAC Type - supervised
Resettable Power ¹	Relay Type - Ignore Open Circuit
HVAC Shutdown RLY ²	Relay Type - Ignore Open Circuit
HVAC Shutdown NAC ²	NAC Type - supervised

1 When using a control relay module to supply resettable power to conventional 2-wire smoke detectors, the addressable monitor module must be programmed for Smoke-Conventional operation
 2 For HVAC SHUTDOWN description, refer to "Control Module Operation" on page 140.

Silenceable

```

EDIT CONTROL
1=ENABLED
2=TYPE
3=SILENCEABLE
    
```

Edit Control Screen #2

The Silenceable selection allows the programmer to select whether output devices connected to the control module can be silenced, either by pressing the Alarm Silence key or by enabling Autosilence. Pressing the 3 key while viewing Edit Control Screen #2 will enable the Silenceable feature causing the display to read *Silenceable Yes*. Repeated presses of the 3 key will cause the display to toggle between *Silenceable Yes* and *Silenceable No*.

Walktest

```

EDIT CONTROL
1=WALKTEST
2=ZONE ASSIGNMENT
000 *** ** ** **
    
```

Edit Control Screen #3

The Walktest feature allows one person to test the system devices without the necessity of manually resetting the control panel after each device activation. To enable devices, which are connected to a control module, for the Walktest feature, press 1 while viewing the Edit Control Screen #3 until the display reads *Walktest Yes*. Each press of the 1 key will cause the display to toggle between *Walktest Yes* and *Walktest No*. Refer to "Walktest" on page 109 for additional information.

Zone Assignment

A maximum of five zones can be programmed to each addressable control module. Pressing 2 while viewing Edit Control Screen #3 displays the following screen:

```

ZONE ASSIGNMENT
Z000 Z*** Z*** Z***
    
```

Zone Assignment Screen

Note that Z*** represents the Zone Number(s) corresponding to this device. The factory default for an unprogrammed device is Z000 for general alarm zone. A flashing cursor will appear on the first 0 to the left. Enter the three digit number corresponding to the zone that is to be assigned to this device. The cursor moves to the next Z*** designation. Continue entering zone assignments or the remaining zones can be left blank or programmed as general alarm zones Z000. When all desired changes have been made, press the Enter key to store the zone assignments. The display will return to the Edit Control Screen #3.

Noun/Adjective

```

EDIT CONTROL
1=NOUN/ADJECTIVE
2=DESCRIPTION
    
```

Edit Control Screen #4

The Noun/Adjective selection allows the programmer to enter specific descriptors about the control module currently being programmed. Pressing 1 while viewing Edit Control Screen #4 will cause the following screen to be displayed:

```

1=STANDARD ADJECTIVE
2=STANDARD NOUN
3=CUSTOM ADJECTIVE
4=CUSTOM NOUN
    
```

Noun/Adjective Screen

```

1=STANDARD ADJECTIVE
2=STANDARD NOUN
3=CUSTOM ADJECTIVE
4=CUSTOM NOUN
Noun/Adjective Screen
    
```

Pressing 1 while viewing the Noun/Adjective Screen will cause the following screen(s) to be displayed. Note that the keyboard *down* arrow key must be pressed to see all the Adjective screens. Press the number corresponding to the adjective that is to be used as a descriptor for the location of the control module currently being programmed.

<pre> ***** 1=NORTH 2=SOUTH 3=EAST </pre> <p>Adjective Screen #1</p>	<pre> ***** 1=WEST 2=FRONT 3=CENTER </pre> <p>Adjective Screen #2</p>	<pre> ***** 1=REAR 2=UPPER 3=LOWER </pre> <p>Adjective Screen #3</p>	<pre> ***** 1=MAIN 2=FIRST 3=2ND </pre> <p>Adjective Screen #4</p>
<pre> ***** 1=3RD 2=4TH 3=5TH </pre> <p>Adjective Screen #5</p>	<pre> ***** 1=FLOOR 1 2=FLOOR 2 3=FLOOR 3 </pre> <p>Adjective Screen #6</p>	<pre> ***** 1=FLOOR 4 2=FLOOR 5 3=ROOM </pre> <p>Adjective Screen #7</p>	

```

1=STANDARD ADJECTIVE
2=STANDARD NOUN
3=CUSTOM ADJECTIVE
4=CUSTOM NOUN
Noun/Adjective Screen
    
```

Pressing 2 while viewing the Noun/Adjective Screen will cause the following screen(s) to be displayed. Note that the keyboard *down* arrow key must be pressed to see all the Noun screens. Press the number corresponding to the noun that is to be used as a descriptor for the location of the control module currently being programmed.

<pre> ***** 1=BASEMENT 2=BOILER RM 3=CLASSROOM </pre> <p>Noun Screen #1</p>	<pre> ***** 1=CLOSET 2=CORRIDOR 3=ELECTRIC RM </pre> <p>Noun Screen #2</p>	<pre> ***** 1=ELEVATOR 2=ENTRANCE 3=FLOOR </pre> <p>Noun Screen #3</p>	<pre> ***** 1=GARAGE 2=HALLWAY 3=HVAC RM </pre> <p>Noun Screen #4</p>
<pre> ***** 1=KITCHEN 2=LOBBY 3=OFFICE </pre> <p>Noun Screen #5</p>	<pre> ***** 1=PATIENT 2=RESTROOM 3=ROOM </pre> <p>Noun Screen #6</p>	<pre> ***** 1=STAIRWAY 2=STOREROOM 3=WING </pre> <p>Noun Screen #7</p>	<pre> ***** 1=ZONE </pre> <p>Noun Screen #8</p>

Pressing 3 or 4 while viewing the Noun/Adjective Screen will display screens similar to the previous Adjective and Noun Screens. The new screens will list Custom Adjectives and Nouns which have been programmed into the control panel using the FS-Tools programming utility.

Description

```

EDIT CONTROL
1=ADJECTIVE/NOUN
2=DESCRIPTION
    
```

Edit Control Screen #4

The Description selection allows the programmer to enter additional information about the control module currently being programmed. This information will be displayed as part of the device label on the display. Pressing 2 while viewing Edit Control Screen #4 will cause the following screen to be displayed:

```

DESCRIPTION 1M002
NOUN/ADJECTIVE
*****
    
```

Adjective/Noun Screen

A flashing cursor will appear at the first asterisk to the left. The programmer can enter additional descriptive information about the device being programmed. This information will appear on the display along with the standard device label information.

A maximum of 20 characters (including spaces) can be entered. To enter alphanumeric characters from the keypad, repeatedly press the appropriate key until the desired character is displayed in the first position. For example, to enter the letter *B*, press the 2 (*ABC*) key three times to toggle through the characters *I*, *A*, and *B*. Press the right arrow key to move the cursor one position to the right and repeat the process to enter the next character. To enter a space, press the * (*QZ*) key four times until a blank appears in the desired position. When all characters have been entered, press the Enter key to store the information. The display will return to the Edit Control Screen #4, displaying the new information at the bottom of the screen.

Recall/Increment Function

In addition, the user may use the Recall/Increment function at any time when the cursor is on the first letter of the Adjective or Noun field as follows:

- If the zero key is pressed, a 0 is placed in the first letter position.
- If the zero key is then pressed a second time with no intervening key actions, the entire Adjective field is replaced with the field entered *for the previous device programmed*, and the cursor moves to the last character of the field (Recall function). The Recalled Adjective or Noun field may now be changed letter-by-letter.
- If the zero key is pressed again with no other intervening key actions and the last character in the field is a number 0-9, the number is incremented by one. If the last character is a letter, it changes to a 0. If the last character is 9 it goes to 0.

- The above increment function may be repeated with each press of the zero key.

As an example, the user could quickly enter 'FLR_3_ROOM 305' as follows:

- The cursor is on the first letter of the Adjective field. Press the zero key twice to display *FLR_3*
- With the cursor on the first letter of the Noun field, press the zero key twice to recall the display *ROOM_304*. The cursor automatically jumps from the first to the last letter of the Noun field.
- With the cursor on the last letter of the Noun field, press the zero key again to increment the room number to *305*.
- Press the right arrow key to advance the zone field
- Select a zone number from 000 to 049. Z000 (default zone) is the general alarm zone. Z001 through Z049 may be selected to link software zones.

Control Module Delay



Edit Control Screen #5

The control module delay feature, if enabled, will delay activation after being triggered by an alarm condition. Pressing 2 while viewing Edit Control Screen #5 will cause the display to change from the factory default of *Ctrl Mod Dly No* to *Ctrl Mod Dly Yes*. Each press of the 1 key will cause the display to toggle between the two options. Delay time varies from 0-180 seconds. See "Control Module Delay" on page 72 to set the delay time. The control module must first be set to *Silenceable No* to enable the Delay Timer.

Wireless



Edit Control Screen #5

The Wireless selection will update automatically if the system recognizes a wireless device. If the module is wireless, the display reads *Wireless Yes*. If the module is wired, the display will read *Wireless No*.

3.6.3 Zone Setup



Programming Screen #2

Pressing 3 while viewing Programming Screen #2 will access the Zone Setup screens as illustrated below:



Zone Setup Screen #1

Zone Setup Screen #2

Zone Setup Screen #3

Enable



Zone Setup Screen #1

Pressing 1 for Enable, while viewing Zone Setup Screen #1, will display the following screen:



Enable Screen

This screens allows the programmer to enable zones, one at a time. A flashing cursor appears next to the Z, prompting the programmer to enter a three digit zone number (001 - 049). When the third digit is entered, the zone will be enabled and the cursor returns to the original position next to the Z. Another zone can then be enabled.

Disable



Zone Setup Screen #1

Pressing 2 for Disable, while viewing Zone Setup Screen #1, displays the following:

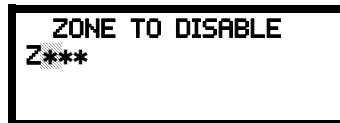

Disable Screen

This screen allows the programmer to disable zones, one at a time. A flashing cursor appears next to the Z, prompting the programmer to enter a three digit zone number (001 - 049). When the third digit is entered, the zone will be disabled and the cursor will return to the original position next to the Z. Another zone can then be disabled.

Special Purpose Zone

Pressing 3 for Special Purpose, while viewing Zone Setup Screen #1, will display the following screens:

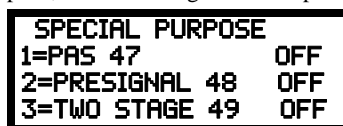

Special Purpose Zone Screen #1

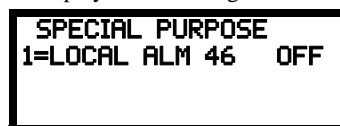

Special Purpose Zone Screen #2

Zones 047, 048, 049, and 046 can be programmed for normal zone operation or for special purpose applications. In the above illustration, the four zones are shown Off, which means they can be programmed to function in the same manner as all other zones, by assigning them to input and output devices in the Programming Zone Assignment Screen.

Pressing 1 will cause the display to change to *PAS 47 On*. Each press of the 1 key will cause the display to toggle between *PAS 47 On* and *PAS 47 Off*. When Zone 047 is programmed On, a PAS (Positive Alarm Sequence) activation of any smoke detector will cause Zone 047 to activate. By assigning Zone 047 to a control module in the Programming Zone Assignment Screen, an output device connected to the control module can be used to indicate a PAS condition in the control panel. *Do not assign Zone 047 to a Notification Appliance Circuit when using this zone to indicate a PAS condition. Attempting to do so will generate an error message and will be prevented by software checks.*

Pressing 2 will cause the display to change to *Pre-signal 48 On*. Each press of the 2 key will cause the display to toggle between *Pre-signal 48 On* and *Pre-signal 48 Off*. When Zone 048 is programmed On, a Pre-signal activation of any device will cause Zone 18 to activate. By assigning Zone 048 to a control module in the Programming Zone Assignment Screen, an output device connected to the control module can be used to indicate a Pre-signal condition in the control panel. *Do not assign Zone 048 to a Notification Appliance Circuit when using this zone to indicate a Pre-signal condition. Attempting to do so will generate an error message and will be prevented by software checks.*

Pressing 3 will cause the display to change to *Two Stage 49 On*. Each press of the 3 key will cause the display to toggle between *Two Stage 49 On* and *Two Stage 49 Off*. Refer to “**Two Stage Operation**” on page 74 for a description of this feature.

Pressing 1 while viewing the Special Purpose Zone Screen #2 will cause the display to change to *Local Alm 46 On*. Each press of the 1 key will cause the display to toggle between *Local Alm 46 On* and *Local Alm 46 Off*. When Zone 46 is programmed On, a Local Alarm activation of any smoke detector will cause Zone 046 to activate. By assigning Zone 046 to a control module in the Programming Zone Assignment Screen, an output device connected to the control module can be used to indicate a local alarm condition in the control panel. *Local Alarm Zone alarms are not reported to the Central Station.*

Zones Installed



Zone Setup Screen #2

Pressing 1 for Zones Installed, while viewing Zone Setup Screen #2, will display a screen similar to the following:



Zones Installed Screen

This display will show all of the zones that have been programmed into the control panel. Note that an up and/or down arrow may appear in the upper right corner of the display, indicating that additional screens of zone information exists. Press the up or down arrow keys to view the additional zones.

Zones Enabled

Pressing 2 for Zones Enabled, while viewing Zone Setup Screen #2, will display a screen similar to the following:



Zones Enabled Screen

This display will show all of the zones that are enabled in the control panel. Note that an up and/or down arrow may appear in the upper right corner of the display, indicating that additional screens of zone information exists. Press the up or down arrow keys to view the additional zones.

Zones Disabled

Pressing 3 for Zones Disabled, while viewing Zone Setup Screen #2, will display a screen similar to the following:



Zones Disabled Screen

This display will show all of the zones that are disabled in the control panel. Note that an up and/or down arrow may appear in the upper right corner of the display, indicating that additional screens of zone information exists. Press the up or down arrow keys to view the additional zones.

Zone Type



Zone Setup Screen #3

Zone Types must be programmed only if a Communicator, programmed for zone reporting, is installed on the control panel. Pressing 1 for Zone Types, while viewing Zone Setup Screen #3, will display a screen similar to the following:



Zones Installed Screen

This display will show the system zones (default and user programmed) and their associated types. Note that an up and/or down arrow will appear in the upper right corner of the display, indicating that additional screens of zone information exists. Press the up or down arrow keys to view zones Z000 through Z049.

Zone types can be changed by pressing the keypad number key corresponding to the zone in each Zones Installed Screen. Available zone types will be displayed in the resultant screens. For example, to change the zone type for zone Z002 in the screen illustrated above, press 3. The following screens will be displayed:



Zone Type Program Screen #1



Zone Type Program Screen #2

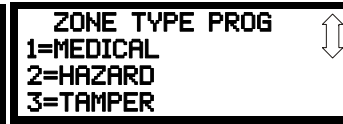

Zone Type Program Screen #3

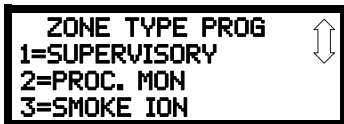

Zone Type Program Screen #4



Zone Type Program Screen #5

To change the zone type for Z002 to Pull Station, scroll the display until Zone Type Program Screen #2 is displayed. Press 2 to program zone Z002 as a Pull Station zone. The display will return to the Zones Installed Screen showing zone Z002 and the Pull Station program type. Repeat the procedure for each zone to be changed.

IMPORTANT! In Zone Type Program Screen #1, selecting WATERFLOW will assign a Waterflow silenceable zone type to the selected zone. Any signaling devices programmed to the same zone can be silenced by pressing the Alarm Silence key or by using the auto-silence feature.

To program a waterflow circuit as nonsilenceable, refer to "System Setup" on page 68.



NOTE: Zone Types are only relevant for Central Station reporting. Changing a zone type will *only* change how it is reported to the Central Station.

Zones Available



Zone Setup Screen #3

Pressing 2 while viewing Zone Setup Screen #3 will display the following screen:



The display will show all of the zones that are still available for programming.

3.6.4 Loop Setup



Programming Screen #2

Loop Setup allows the programmer to configure the SLC Loop for NFPA Class A or B wiring and to select the loop protocol. Pressing 1 while viewing Programming Screen #2 will cause the following screen to be displayed:

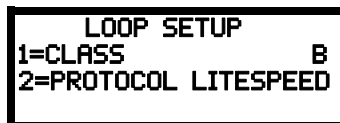

Loop Setup Screen

Class

To program the SLC Class for the selected loop, press *I* for Class, while viewing Loop Setup Screen. In the preceding example, the control panel is programmed for Class B SLC wiring as indicated by the *B* to the right of *Class* in the display. To change the wiring style, press *I* to toggle the display to read *Class A*. Each press of the *I* key will cause the display to toggle between *Class B* and *Class A*.



NOTE: If the FACP reports an open fault on an SLC Loop programmed for Class A, the trouble condition will latch at the FACP. When the SLC Loop has been repaired, the Reset button must be pressed at the FACP (at least 2 minutes after the trouble has been repaired) to clear the SLC trouble.

Loop Protocol

Loop Protocol refers to the SLC loop mode of operation. Refer to “Wire Requirements” on page 138 for wire specifications based upon SLC protocol. There are two Loop Protocols available, each of which will work with the addressable devices in the FireWarden SLC manual:

- CLIP (Classic Loop Interface Protocol) - not recommended due to slower response times.
- FlashScan (displayed as “LiteSpeed”, factory default setting) - results in quicker response times and is the recommended protocol for use with this panel.

Pressing *2* while viewing the Loop Setup Screen will toggle between *CLIP* and *FlashScan* Protocols.

Device Addressing

It is important to note that the NFW-50X addressable device capacity is 50 detectors and control/ monitor modules. Addressable devices must not be set to addresses higher than 50. Programming will not allow addresses higher than 50.

3.6.5 System Setup

System Setup allows the programmer to configure the following control panel features:

- *Function Keys:* This feature allows the user to rapidly enable/disable various fire panel inputs and outputs during scheduled maintenance.
- *Banner:* This option allows the user to change the top two lines of the LCD display from the blank factory default readout to a user defined readout when the control panel is in Normal condition.
- *Time-Date:* This feature allows the programmer to set the time, display format (24 hr or 12 hr), date and daylight savings time feature into the FACP memory
- *Timers:* This option allows the programmer to set the PAS (Positive Alarm Sequence) time delay, Pre-Signal time delay and Waterflow time delay.
- *NACs:* This feature allows the programmer to configure the control panel Notification Appliance Circuits for a variety of options, such as circuit type, silenceable/nonsilenceable, autosilence, coding, silence inhibit, zone assignment and enable/disable.
- *Relays:* This option allows programming of two onboard relays for activation by various control panel events, such as alarm, trouble, supervisory, etc.
- *Canadian Option:* This option allows the programming of certain options to Canadian specifications.
- *Waterflow Silenceable:* This option provides the ability to silence any output circuit activated by a monitor module programmed as a waterflow type.
- *Auxiliary Power:* This option configures the use of the 24VDC auxiliary power output at TB11 on the FACP.
- *Trouble Reminder:* This feature provides an audible reminder that an alarm or trouble still exists on the FACP after the control panel has been silenced. The control panel piezo sounder will pulse once every 15 seconds during an alarm and every two minutes during a trouble condition, after the Alarm Silence or Acknowledge key is pressed. The piezo will continue to sound at these rates until the alarm or trouble condition is cleared. If the trouble condition is not cleared within a selected time of either 4 or 24 hours, the panel will reactivate the trouble sounder and retransmit the trouble condition to the central station if connected. When used with SWIFT wireless devices, the Trouble Reminder must be set to 4 hours.
- *Language:* This option allows the user to switch between English and French language text on the panel display.
- *Charger Enable:* This option allows the user to install an external battery charger.
- *4XTM Supervision:* This feature enables supervision of an installed 4XTM Transmitter Module.
- *Remote Sync Enable:* This feature controls the activation of notification appliances in such a way that all devices will turn on and off at exactly the same time.



Programming Screen #2

Pressing *2* for System Setup, while viewing Programming Screen #2, will cause the following screens to be displayed:



System Setup Screen #1

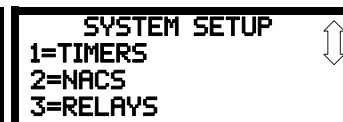

System Setup Screen #2

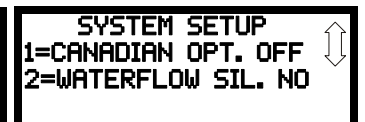

System Setup Screen #3



System Setup Screen #4

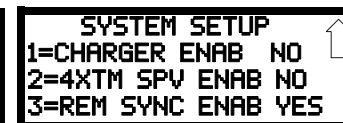

System Setup Screen #5

Function Keys

The NFW-50X keypad has 4 programmable function keys. These keys can be programmed to allow rapid disable/enable of various fire panel inputs and outputs during scheduled maintenance. Pressing any function key results in a trouble signal at the panel. Pressing 1 on System Setup Screen #1 displays the following:



Function Keys Screen

Select 1, 2, 3, or 4 to program the corresponding Function Key. The following screens display for each Function Key where "(X)" represents the number of the key chosen.

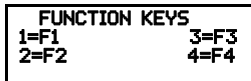

Function Keys Screen



Function Keys Screen #1

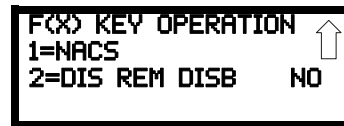

Function Keys Screen #2

To Enable or Disable the Function Key, press the 1 key while viewing the Function Keys Screen #1. Each press of the key will toggle the screen between *Key Enabled Yes* and *Key Enabled No*.

Pressing 2 key while viewing the Function Keys Screen #1 allows the user to select individual zones that the Function Key will control. Pressing 3 assigns all zones to the selected Function Key.

Each function key can be assigned to control any of the 2 onboard NAC circuits on the NFW-50X. By pressing the 2 key while viewing the Function Keys Screen #2 the following screen displays, allowing the user to select the desired NAC circuit(s).

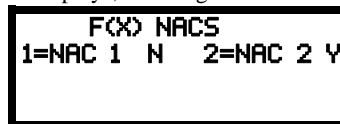

Function Keys Screen

Pressing 1 or 2 toggles the screen between *Yes* (controlled by function key) and *No* (not controlled by function key) for each onboard NAC circuit.



Function Keys Screen #2

The Remote Synchronization (TB8 on the FACP's main circuit board) can also be disabled through programming of a function key. To disable remote synchronization, press the 3 key while viewing the Function Keys Screen #2. Each press of the key will toggle the screen between *Rem Sync Disb Yes* and *Rem Sync Disb No*.

Banner



System Setup Screen #1

The top line of the display, which appears when the control panel is in normal mode, can be changed by using the Banner option. Pressing 2 while viewing System Setup Screen #1 will cause the following to be displayed:



Banner Screen

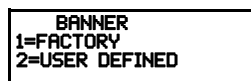

Banner Screen

Pressing 1 while viewing the Banner Screen will select the blank factory default banner setting and display the following screen:



Factory Banner Screen

Pressing the Enter key will store this selection in nonvolatile memory and return the display to the Banner Screen.

Pressing 2 while viewing the Banner Screen will cause the following screens to be displayed:

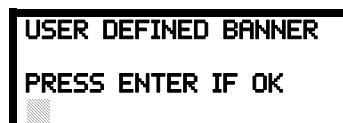

User Defined Banner Screen #1



User Defined Banner Screen #2

These screens allow the programmer to enter a two line custom banner. A flashing cursor will appear in the bottom left corner of each display. A maximum of 20 characters (including spaces) can be entered into each screen for a total of two lines with 40 characters. After entering up to 20 characters in the first screen, press *Enter* to view the second screen. Enter up to 20 characters in the second screen in the same manner or just press *Enter* if a second banner line is not being entered. To quickly clear the current banner, press the *CLR* key.

To enter alphanumeric characters from the keypad, repeatedly press the appropriate key until the desired character is displayed in the first position. For example, to enter the letter *B*, press the *2 (ABC)* key three times to toggle through the characters *I*, *A*, and *B*. Press the right arrow key to move the cursor one position to the right and repeat the process to enter the next character. To enter a space, press the *9 (YZ)* key four times to place a blank in the desired position. When all characters have been entered, press the *Enter* key to store the information. The display will return to the Banner Screen.

Time-Date



System Setup Screen #1

The control panel time and date can be changed by pressing *3* while viewing the System Setup Screen #1. The following screen will be displayed:



Time-Date Screen #1



Time-Date Screen #2

■ Time

To change the time, press *1* while viewing the Time-Date Screen. The following screen will be displayed:



Time Screen

A flashing cursor is located toward the top left of the display. Below the cursor is the current time. To change the time, enter the two-digit hours followed by the two-digit minutes. The cursor will move one position to the right each time a digit is entered. After the last minutes digit is entered, the cursor will again move one position to the right. At this point enter *1* for AM or *2* for PM. The display will then return to the Time-Date Screen which will show the new time entry. If an error is made while entering a digit, press the *CLR* key to delete the entire entry and beginning again.

■ Date

To change the date, press *2* while viewing the Time-Date Screen. The following screen will be displayed:



Date Screen

A flashing cursor is located toward the top left of the display. Below the cursor is the current date. To change the date, enter the two-digit month followed by the two-digit day and then the two-digit year (17 for 2017, 18 for 2018, etc.). The cursor will move one position to the right each time a digit is entered. After the last year digit is entered, the display will return to the Time-Date Screen which will show the new date entry. If an error is made while entering a digit, press the *CLR* key to delete the entire entry and beginning again.

■ Clock Format

The clock can be configured to display 12 hour (AM & PM) or 24 hour (military) time. Pressing *3* while viewing the Time-Date screen will cause the display to toggle between 12HR and 24HR. Select 12HR for 12 hour display or 24HR for 24 hour display.



NOTE: If the clock is changed to 24 hour (military) format, the date will change to the European standard of **Day-Month-Year** (for display purposes only).

■ Daylight Savings Time



Time & Date Screen #2

Pressing *1* while viewing Time-Date Screen #2 will cause the following screens to be displayed:



Daylight Savings Screen #1



Daylight Savings Screen #2

Pressing *1* while viewing Daylight Savings Screen #1 will cause the display to toggle between *Enabled Yes* and *Enabled No*. The control panel will automatically update the time for daylight savings time when *Enabled Yes* is selected.

Pressing *2* while viewing Daylight Savings Screen #1 will display another screen which allows the programmer to select the month that daylight savings time will begin. In this sub-screen, pressing *1* will select March, *2* will select April, and *3* will select May.

Pressing 3 while viewing Daylight Savings Screen #1 will display two sub-screens which allow the programmer to select the week of the month that daylight savings time will begin. In the first sub-screen, pressing 1 will select the first week, 2 will select the second week and 3 will select the third week, while in the second sub-screen, pressing 1 will select the fourth week and 2 will select the last week of the selected month.

Pressing 1 while viewing Daylight Savings Screen #2 will display another screen which allows the programmer to select the month that daylight savings time will end. In this sub-screen, pressing 1 will select September, 2 will select October, and 3 will select November.

Pressing 2 while viewing Daylight Savings Screen #2 will display two sub-screens which allow the programmer to select the week of the month that daylight savings time will end. In the first sub-screen, pressing 1 will select the first week, 2 will select the second week and 3 will select the third week, while in the second sub-screen, pressing 4 will select the fourth week and 5 will select the last week of the selected month.

Timers



System Setup Screen #2

Timer delays for PAS, Pre-signal and waterflow activation can be programmed by pressing 1 while viewing System Setup Screen #2. The following screen will be displayed:



Timer Screen #1



Timer Screen #2

■ PAS (Positive Alarm Sequence) Delay

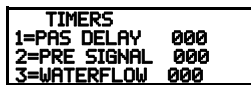

Timer Screen #1

The factory default setting for PAS is 000 for no delay. To select a PAS delay of 001 to 180 seconds for all devices programmed for PAS, press 1 while viewing Timer Screen #1. The following display will appear:



PAS Delay Screen

A flashing cursor is positioned in the lower left corner of the display. Enter a delay time consisting of three digits, such as 005 for five seconds. Upon entering the third digit, the time delay will be stored in the control panel memory and the display will return to the Delay Screen which will indicate the new delay time.

■ Pre-signal Delay

The factory default setting for Pre-signal delay is 000 for no delay. To select a Pre-signal delay of 001 to 180 seconds for all devices programmed for Pre-signal, press 2 while viewing Timer Screen #1. The following screen will be displayed:



Pre-signal Delay Screen

A flashing cursor is positioned in the lower left corner of the display. Enter a delay time consisting of three digits, such as 009 for nine seconds. Upon entering the third digit, the time delay will be stored in the control panel memory and the display will return to the Delay Screen which will indicate the new delay time.

Note that the FACP allows programming for PAS and Pre-signal timers, but a detector can only be programmed for either PAS or Pre-signal operation. Refer to "Edit Detector" on page 51 for programming details.

■ Waterflow Delay



Timer Screen #1

A delay can be added prior to declaring a waterflow type of alarm. Be careful to include any built-in delays of the waterflow device. The factory default setting for Waterflow delay is 000 for no delay. To select a Waterflow delay of 01 to 90 seconds for all devices programmed for Waterflow delay, press 3 while viewing Timer Screen #1. The following screen will be displayed:

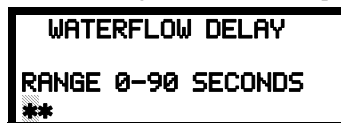

Waterflow Delay Screen

A flashing cursor is positioned in the lower left corner of the display. Enter a delay time consisting of two digits, such as 25 for twenty-five seconds. Upon entering the second digit, the time delay will be stored in the control panel memory and the display will return to the Delay Screen which will indicate the new delay time.

■ AC Loss Delay

```
TIMER
1=AC LOSS DELAY 2
2=CTRL MOD DLY 000
```

Timer Screen #2

The reporting of a loss of AC power to a central station can be delayed by programming the length of the desired delay. The factory default setting is 2 hours. Press 1 while viewing Timer Screen #2 to display the following:

```
AC LOSS DELAY
1=NO DELAY
2=ENTER DELAY
```

AC Loss Delay Screen #1

Pressing 1 while viewing AC Loss Delay Screen #1 will program the FACP to transmit an AC Loss report immediately to the central station.

Pressing 2 while viewing AC Loss Delay Screen #1 will display the following:

```
AC LOSS DELAY
RANGE 00-23
**
```

AC Loss Delay Screen #2

A flashing cursor will appear in the lower left corner of the display. Type the two digit AC loss reporting delay in hours (00 to 23 hour delay). When the second digit is entered, the display will return to AC Loss Delay Screen #1. Refer to the table on page 46 for permissible settings.



NOTE: Upon the loss of AC power at the control panel, relays programmed for 'AC Loss' will transfer immediately, regardless of the AC Loss Delay setting. If no trouble exists at the panel other than AC Loss, the System Trouble relay will delay its activation for the duration of the AC Loss Delay setting.

■ Control Module Delay

```
TIMER
1=AC LOSS DELAY
2=CTRL MOD DLY
```

Timer Screen #2

The control module delay feature, if enabled, will delay activation of a control module after being triggered by an alarm condition. Pressing 2 while viewing Timer Screen #2 will display the following:

```
CTRL MOD DELAY
RANGE 0-180 SECONDS
***
```

Control Module Delay Screen

A flashing cursor will appear in the lower left corner of the display. Type the three digit control module delay in seconds (000 to 180 second delay). When the third digit is entered, the display will return to the Delay Screen which will indicate the new delay time. Refer to the table on page 46 for permissible settings.

NACS (Notification Appliance Circuits)

```
SYSTEM SETUP
1=TIMERS
2=NACS
3=RELAYS
```

System Setup Screen #2

The options for the NACs on the control panel main circuit board can be configured by pressing 2 while viewing System Setup Screen #2. The following screens will be displayed:

```
NACS
1=NAC 1
2=NAC 2
```

NAC Selection Screen

The Notification Appliance Circuits can be configured independently by pressing 1 for NAC 1 or 2 for NAC 2.

The following screens will be displayed for each selection:

```
NAC #
1=ENABLED YES ↓
2=TYPE SYNCED STROBE
3=SILENCEABLE YES
```

NAC Screen #1

```
NAC #
1=AUTO SILENCE 00 ↑↓
2=CODING STEADY
```

NAC Screen #2

```
NAC #
1=ZONE ASSIGNMENT ↑↓
000 *** ** NO
2=SILENC INHIBIT NO
```

NAC Screen #3

```
NAC #
1=SYNC TYPE S ↑
```

NAC Screen #4

■ Enabled

Pressing 1 while viewing NAC Screen #1 will cause the display to change to *Enabled No*. This will prevent the selected main circuit board NAC from activating its devices. Each press of the 1 key will cause the display to toggle between *Enabled Yes* and *Enabled No*.



NOTE: The programming for NAC 1 will determine the operation of the remote power supply sync.

■ **Type**

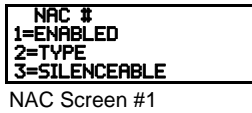

The main circuit board NAC type can be programmed by pressing 2 while viewing NAC Screen #1. The following screen will be displayed. Press the down arrow key to view additional screens:

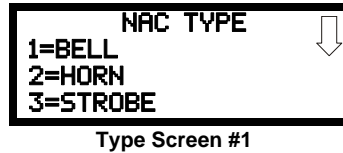

Select the NAC device type by pressing the number corresponding to the type in the appropriate screen. When the selection is made, the display will return to NAC Screen #1.

The following table contains NAC type codes and their functions:

NAC Type Code	Special Function
Bell	None
Horn	None
Strobe	None
Synced Strobe	Synchronized to manufacturer
Strobe Sil Sync	Same as Synced Strobe but Silence turns off audible & visual devices
Future Use	None
Future Use	None
Future Use	None
Blank	None

■ **Silenceable**

Pressing 3 while viewing NAC Screen #1 will cause the display to change to *Silenceable No*. This will prevent the selected main circuit board NAC from being silenced by pressing the Alarm Silence key or by the Auto Silence feature. Each press of the 3 key will cause the display to toggle between *Silenceable Yes* and *Silenceable No*.

Important: When a Notification Appliance Circuit with a mix of audible and visual devices is programmed for silenceable and the **Synced Strobe** feature is selected, only the audible devices will be turned off if the Silence key is pressed or if the Autosilence feature is enabled. The visual devices (strobes, etc.) will continue to operate. If the **Strobe Sil Sync** feature is selected, Silence or Autosilence will turn off both audible and visual devices.

■ **Auto Silence**

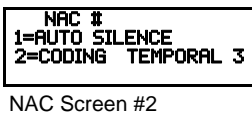

The Auto Silence feature, when enabled, automatically silences all main circuit board silenceable notification appliances after a programmed length of time. To enable this feature and program the time delay before Auto Silence activation, press 1 while viewing NAC Screen #2. The following screens will be displayed:



To disable the Auto Silence feature, press 1 for *No* while viewing Auto Silence Screen #1. To enable the Auto Silence feature, press the number corresponding to the time delay which will elapse before Auto Silence activates. This information will be stored in memory and the display will return to NAC Screen #2.



NOTE: All silenceable control modules as well as the remote power supply sync will be controlled by the Autosilence timer for NAC 1.

■ **Coding (only for NACs not programmed as Sync Strobe Type)**

The Coding feature allows the programmer to select the type of output that the main circuit board notification appliances will generate when activated. Pressing 2 while viewing NAC Screen #2 will cause the following displays to appear:

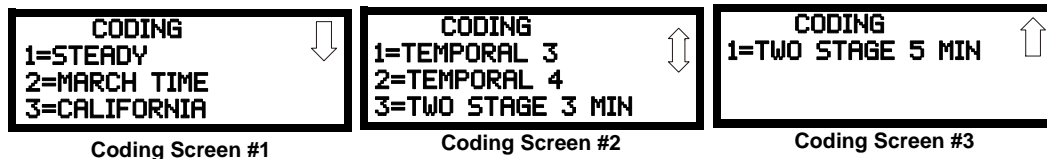

The programmer can select the notification appliance output by pressing the number corresponding to the desired output. The coding selections are:

- Steady - a continuous output with no coding
- March Time - 120 ppm (pulse-per-minute) output

- California - 10 seconds on and 5 seconds off
- Temporal 3 - ½ Second On, ½ Second Off, ½ Second On, ½ Second Off, ½ Second On, 1½ Seconds Off
- Temporal 4 - ½ Second On, ½ Second Off, ½ Second On, ½ Second Off, ½ Second On, ½ Second Off, ½ Second On, 1½ Seconds Off
- Two Stage - refer to, "**Two Stage Operation**" below for a description

Selection of one of the above options will cause the control panel to store the information in memory and return the display to NAC Screen #2, which will display the new coding choice.

Two Stage Operation

Two Stage operation consists of the following:

- 1st stage output - 20 ppm (pulse-per-minute) coding
- 2nd stage output - Temporal coding as described above
- F2 button functions as the two stage advance to stage two button
- F3 button functions as the automatic alarm signal cancel button

If Two Stage operation is programmed as the Coding option, the following sequence of events will occur during an alarm.

1. The on-board NACs which are programmed to General Alarm Zone 000 will activate with a 1st stage output upon activation of any alarm point.
2. If the activated alarm point is directly mapped to a zone which is programmed to an on-board NAC, that NAC will go directly to 2nd stage coding output. All other NACs not directly mapped to the activated alarm point's zone but assigned to Zone 000 will activate with a 1st stage output.
3. If, after the programmed time of 3 or 5 minutes, the Acknowledge switch has not been pressed, all NACs presently in 1st stage activation will go to 2nd stage activation.
4. If an F3 switch has been pressed, the Alarm LED will turn from flashing to steady. Any NACs currently in 1st stage activation will remain in 1st stage. Pressing the Acknowledge switch does not affect NACs already in 2nd stage activation.
5. If an F2 button in pressed, the NACs will progress to the second stage.
6. If another alarm point is activated and the countdown timer is counting, the alarm point will have no effect on the NACs unless the alarm point's zones are directly mapped to one of the NACs, in which case it will follow the procedure outlined in step 2.
7. If another alarm point is activated and the countdown timer has stopped counting due to the Acknowledge switch being pressed, the countdown timer will restart and the NACs will respond as outlined in step 2. NACs that are already in 2nd stage activation will not be affected.
8. Any control modules assigned to special Zone 049 will be activated either by direct mapping of an input device programmed to Zone 049 or if the timer counts down to zero or when any NAC goes into 2nd stage coding.
9. Control modules that are programmed to the same zone as the activated input device will not be delayed for activation.

■ **Zone**

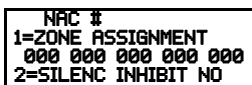

NAC Screen #3

A maximum of five zones can be programmed to each main circuit board NAC. Pressing 1 while viewing NAC Screen #3 displays the following screen:



Zone Screen

Note that Z*** represents the Zone Number(s) corresponding to the selected NAC. The factory default for an unprogrammed device is Z000 for general alarm zone. A flashing cursor will appear on the first 0 to the left. Enter the three digit number corresponding to the zone that is to be assigned to this NAC. The cursor moves to the next Z*** designation. Continue entering zone assignments or the remaining zones can be left blank or programmed as general alarm zone Z000. When all desired changes have been made, press the Enter key to store the zone assignments. The display will return to the NAC Screen #3 which will show the zone assignments just entered.

■ **Silence Inhibit**

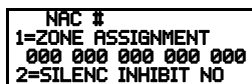

NAC Screen #3

The Silence Inhibit feature, when enabled, prevents the silencing of the selected main circuit board NAC for a period of five minutes. Resetting the FACP will also be prevented for one minute while the NAC programmed for silence inhibit is activated. Pressing 2 while viewing NAC Screen #3 will cause the display to change from the factory default of *Silence Inhibit No* to *Silence Inhibit Yes*. Each press of the 2 key will cause the display to toggle between the two options.

■ **Sync Type**

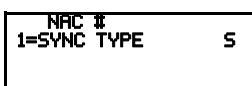

NAC Screen #4

If synchronized strobes were selected as the Type of device installed, the type of synchronization must be selected in this option. Pressing 1 while viewing NAC Screen #4 will cause the following screen to be displayed:



Pressing 1 while viewing this screen will select System Sensor synchronization, 2 will select Wheelock, and 3 will select Gentex.

Maximum Number of Strokes for Synchronization

The total current draw for each Notification Appliance Circuit cannot exceed 2.5 amps. Refer to the manufacturer’s documentation supplied with the Strobes to determine the maximum current draw for each strobe and ensure that the circuit maximum is not exceeded. To ensure proper strobe and circuit operation, there is also a limit to the number of strobes that can be attached to each circuit.

Relays

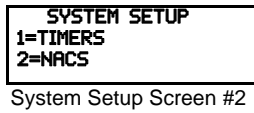

Pressing 3 while viewing System Setup Screen #2 will allow the programmer to configure two main circuit board Form-C relays from the following screen:



To program Relay 1 or Relay 3, press the number corresponding to the selected relay. Note that Relay 2 is fixed as a Trouble relay. Selecting Relay 2 will have no effect on its programming. The following screen will appear for each relay to be programmed:

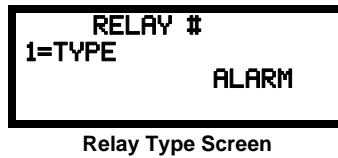

Pressing 1 for Type while viewing the Relay Screen will cause the following screens to be displayed:

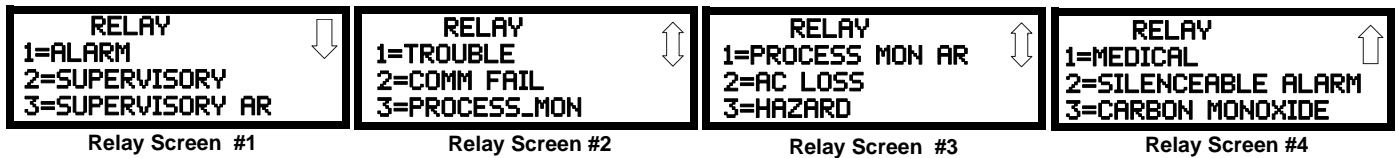

While viewing the selected screen, press the number corresponding to the desired relay type to program the main circuit board relay. The choice will be stored in memory and the display will return to the Relay Type Screen which will show the programmed type choice. Press the Escape key to return to the Relays Selection Screen and repeat the preceding procedure for the remaining relays.



NOTE:

1. AR (*AutoResetable*) in SUPERVISORY AR and PROCMON AR means that a relay with the Supervisory and/or Process Monitor type code, when activated, will automatically reset when the corresponding condition is cleared.
2. A relay programmed with the Silenceable Alarm type will activate upon any alarm and deactivate when the FACP Alarm Silenced LED is illuminated.

Canadian Option



Pressing 1 while viewing System Setup Screen #3 will configure the FACP to comply with Canadian requirements. The display will change to *Canadian Opt. On*. Each press of the 1 key will cause the display to toggle between *Canadian Opt. On* and *Canadian Opt. Off*. Refer to the table on page 46 for permissible settings.

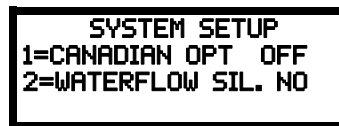

Important! For Canadian Applications, this option must be set to ON prior to any other panel programming.

The Canadian Options configures the FACP with the following as required by Canada:

- The following monitor module type codes are **not** available:
 - ✓ monitor
 - ✓ non-latching supervisory
 - ✓ non-latching drill
 - ✓ non-latching process monitor
 - ✓ process monitor
 - ✓ hazard
 - ✓ tornado
 - ✓ medical alert
- The auto-silence timer is fixed at 20 minutes and cannot be changed.
- Addressable ionization smoke detector sensitivity is automatically monitored using Canadian specifications.
- The Positive Alarm Sequence and Pre-Signal option are not available for Canadian applications.

- The F1 function key is automatically configured to perform a manual alarm signal activation when pressed.
- The F2 function key is automatically configured to perform a two-stage bypass when pressed.
- If NACs are set up for two-stage operation, the Silence Inhibit timer is automatically enabled and is fixed at 5 minutes.
- AlarmNet supervision settings are fixed at 3 minutes and cannot be changed regardless of supervision programming selection.

Waterflow Silenceable

```

SYSTEM SETUP
1=CANADIAN OPT. OFF
2=WATERFLOW SIL. NO
    
```

System Setup Screen #3

Pressing 2 while viewing System Setup Screen #3 will allow the programmer to configure the system for silenceable on nonsilenceable waterflow circuits. Each press of the 2 key will toggle the display between *Waterflow Sil. No* and *Waterflow Sil. Yes*. When *Waterflow Sil. No* is selected, all output devices associated with a waterflow type input device, will be nonsilenceable. When *Waterflow Sil. Yes* is selected, all output devices associated with a waterflow type input device, will be silenceable.

Auxiliary Power

```

SYSTEM SETUP
1=AUX POWER
2=TROUBLE REM 24HR
3=LANGUAGE ENGLISH
    
```

System Setup Screen #4

A Special Application 24 VDC power output is available at TB11 on the main circuit board. Pressing 1 while viewing System Setup Screen #4 displays the following:

```

AUX POWER
1=AUX 1
    
```

Select the AUX 1 output. The following screen will be displayed.

```

AUX 1
1=CLASS A YES
2=RESETTABLE YES
    
```

Aux 1 can be programmed for Class A wiring. If Aux 1 is to be wired for Class A, press 1. Each press of the 1 key will cause the display to toggle between *Class A Yes* and *Class A No*.

In addition, the aux power output can be programmed as resettable or non-resettable power. Non-resettable power is suitable for powering annunciators while resettable power is suitable for powering smoke detectors. Each press of the 1 key will cause the display to toggle between *Resettable Yes* and *Resettable No*.

Trouble Reminder

```

SYSTEM SETUP
1=AUX POWER
2=TROUBLE REM 24HR
3=LANGUAGE ENGLISH
    
```

System Setup Screen #4

The Trouble Reminder features causes the control panel piezo to sound a reminder ‘beep’ for alarms and troubles, after the panel has been silenced. Refer to “Trouble Reminder” on page 68, for a detailed description of this feature. Pressing 2 while viewing System Setup Screen #4 will cause the display to toggle to *Trouble Rem 4* or *Trouble Rem 24*, which enables this feature for resound at either 4 or 24 hours, respectively. Each press of the 2 key will cause the display to toggle between *Trouble Rem 4* or *Trouble Rem 24*. Refer to the table on page 46 for permissible settings.

Language

```

SYSTEM SETUP
1=AUX POWER
2=TROUBLE REM 24HR
3=LANGUAGE ENGLISH
    
```

System Setup Screen #4

The language option is used to change the text on the panel display to either English or French. Pressing the 3 key will cause the display to offer a choice of 1=*English* and 2=*French*.

Charger Enable

```

SYSTEM SETUP
1=CHARGER ENAB YES
2=4XTM SPV ENAB NO
3=REM SYNC ENAB YES
    
```

System Setup Screen #5

If using an external battery charger, the FACP battery charger must first be disabled. Pressing 1 while viewing System Setup Screen #5 will cause the display to toggle to *Charger Enab No*, which will allow the use of an external battery charger. Each press of the 1 key will cause the display to toggle between *Charger Enab. No* and *Charger Enab. Yes*.

4XTM Supervision

```

SYSTEM SETUP
1=CHARGER ENAB YES
2=4XTM SPV ENAB NO
3=REM SYNC ENAB YES
    
```

System Setup Screen #5

If a 4XTM Transmitter Module is installed in the system, supervision must enabled in user programming. Pressing 2 while viewing System Setup Screen #5 will cause the display to toggle to *4XTM Supv Enab. Yes*, which means there is a 4XTM installed. Each press of the 2 key will cause the display to toggle between *4XTM Supv Enab. No* and *4XTM Supv Enab. Yes*. Refer to the table on page 46 for permissible settings.

Remote Sync Enable

```

SYSTEM SETUP
1=CHARGER ENAB YES
2=4XTM SUPV ENAB NO
3=REM SYNC ENAB YES
    
```

System Setup Screen #5

Synchronization is a feature that controls the activation of notification appliances in such a way that all devices will turn on and off at exactly the same time. Refer to Section 2.5, “Remote Synchronization Output”, on page 26 for more information. To enable remote synchronization, press the 3 key while viewing System Setup Screen #5. Each press of the key will toggle the screen between *Rem Sync Enab Yes* and *Rem Sync Enab No*.

3.6.6 History

```

PROGRAMMING
1=HISTORY
2=COMMUNICATOR
3=ANNUNCIATORS
    
```

Programming Screen #3

The History option allows an authorized user to view or erase events which have occurred in the control panel. Pressing 1 while viewing Programming Screen #3 will display the History options as shown in the following display:

```

HISTORY
1=VIEW EVENTS
2=ERASE HISTORY
    
```

History Screen

View Events

```

HISTORY
1=VIEW EVENTS
2=ERASE HISTORY
    
```

History Screen

Pressing 1 while viewing the History Screen will allow the user to select the events to be viewed as illustrated in the following:

```

HISTORY
1=VIEW ALL
2=VIEW ALARMS
3=VIEW OTHER EVENTS
    
```

View Events Screen

While displaying the View Events screen, press 1 to view all events, 2 to view only alarms or 3 to view other events. Use the up and down arrow keys to scroll through all of the displayed events.

Erase History

The Erase History option allows a user to erase all events from the history file. This will provide a clean slate in order to use the history file to track future events. Pressing 2 while viewing the History Screen will display the following screen:

```

ERASE HISTORY
PROCEED ?
1=YES      2=NO
    
```

Erase History Screen

Pressing 1 while viewing the Erase History Screen will erase all events from the History file. During this process, the display will read as follows:

```

ERASING HISTORY
PLEASE WAIT
    
```

Erase History Wait Screen

After the History file has been erased, the display will return to the History Screen.

3.6.7 Communicator

```

PROGRAMMING
1=HISTORY
2=COMMUNICATOR
3=ANNUNCIATORS
    
```

Programming Screen #3

The communicator settings allow the user to configure the settings for the pre-installed IPOTS-COM and CELL-MOD/CELL-CAB-N if installed in the system. Pressing 2 while viewing the Programming Screen #3 will cause the following Communicator options to be displayed:

<pre> COMMUNICATOR 1=INSTALLED YES 2=POTS SETTINGS 3=IP SETTINGS </pre> <p>Communicator Screen #1</p>	<pre> COMMUNICATOR 1=PRI COMM PATH 2=SEC COMM PATH 3=TBL REPRT LIMIT 0 </pre> <p>Communicator Screen #2</p>	<pre> COMMUNICATOR 1=REPORT STYLE POINT 2=EVENT CODES </pre> <p>Communicator Screen #3</p>
---	---	--

Communicator Installed

The pre-installed communicator provides communication to a central station. Use of the communicator requires it be enabled in user programming. Pressing 1 while viewing the Communicator Screen #1 will change the display to *Installed No*. Each press of the 1 key will cause the display to toggle between *Installed Yes* and *Installed No*.

POTS Settings

```

COMMUNICATOR
1=INSTALLED NO
2=POTS SETTINGS
3=IP SETTINGS
    
```

Communicator Screen #1

The POTS settings configure the system when telephone lines are used to contact central station. Pressing 2 while viewing the Communicator Screen #1 will display the following.

```

POTS SETTINGS
1=LINE 1
2=LINE 2
3=GAINS
    
```

POTS Settings Screen

■ POTS Line (X)

If telephone lines are connected to the IPOTS-COM board at J4 (Line 1) and J5 (Line 2), their settings can be configured by pressing 1 or 2, respectively. Pressing 1 or 2 will display the following screen. The programming options for Line 1 and Line 2 are identical.

```

POTS LINE X
1=ENABLED YES
2=TYPE TOUCHTONE
3=SUPERVISED YES
    
```

POTS Line X Screen

Phone Line (X) Enable

To enable the phone line, press 1 while viewing the POTS Line (X) Screen #1 to change the display to *Enabled Yes*. Each press of the 1 key will cause the display to toggle between *Enabled Yes* and *Enabled No*.

Type

```

POTS LINE X
1=ENABLED YES
2=TYPE
3=SUPERVISED YES
    
```

POTS Line X Screen

To select the type, press 2 while viewing the POTS Line (X) Screen #1. The following screen will be displayed:

```

TYPE
1=TOUCHTONE
2=ROTARY 67/33
3=ROTARY 60/40
    
```

Type Settings Screen

Press 1 to select Touchtone dialing, 2 to select Rotary dialing with a make/break ratio of 67/33 or 3 to select Rotary dialing with a make/break ratio of 60/40.

Supervised Phone Line

```

POTS LINE X
1=ENABLED YES
2=TYPE
3=SUPERVISED YES
    
```

POTS Line X Screen

The Supervised Phone Line feature allows the user to disable the supervision of Phone Lines when using an alternate means of secondary transmission path. The factory default setting is Phone Line (X) supervised. Supervision must be set to *Yes* if the selected transmission path is POTS.

Pressing 1 for *Supervision* while viewing the POTS Line (X) Screen #2 will change the screen to read *Supervision No*. Each press of the 1 key will toggle the option between *Supervise Yes* and *No*. Refer to the table on page 46 for permissible settings.

■ Gains

```

POTS SETTINGS
1=LINE 1
2=LINE 2
3=GAINS
    
```

POTS Settings Screen

The Gains value is the telephone's transmitting "volume control". To adjust the settings, press 3 while viewing the POTS Settings screen. The following screen will be displayed:

```

GAINS
1=DIALING NORM
2=REPORTING NORM
    
```

Gains Screen

The Gains value can be adjusted for when the telephones lines are in use for Dialing and Reporting. Press 1 or 2 to change these values, respectively. The following screen will display for both options.

```

GAINS
1=LOW
2=NORMAL
3=HIGH
    
```

Gains Screen

Press 1 for *Low*, 2 for *Normal*, and 3 for *High*. After the Gains value has been selected, the display will return to the Gains Screen.

IP Settings



The IP settings configure the system when the central station will be contacted over the internet. The following screens allow the user to enter the device addresses needed for communication. Pressing 3 while viewing the Communicator Screen #1 will display the following.

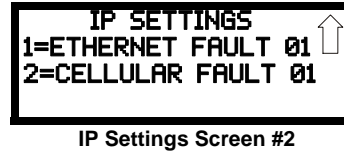
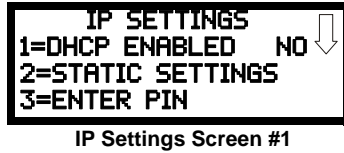

■ DHCP Enabled

If the internet router used by the IPOTS-COM is configured for DHCP (Dynamic Host Configuration Protocol) where addresses are automatically assigned, press 1 while viewing the IP Settings Screen to change the display to *Enabled Yes*. Each press of the 1 key will cause the display to toggle between *Enabled Yes* and *Enabled No*. If the DHCP is enabled, the Static Settings option will disappear since there is no need to enter addresses manually.

■ Static Settings

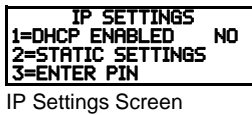

The Static Settings are used to set the addresses manually if the DHCP is not enabled. Press 2 on the IP Settings Screen. The following screens will display:



The A flashing cursor will appear on the first X to the left. Enter the twelve digit address. When the address has been entered, press the Enter key to store the address number. The display will return to the IP Settings Screen.

■ PIN

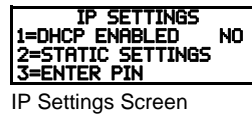

In the event that the Communicator needs to be replaced, the device will need to be re-registered with AlarmNet. AlarmNet will issue a PIN to be entered into the panel for verification. Pressing 3 on the IP Settings screen will display the following.



Enter the 4 digit PIN provided by AlarmNet and press Enter. The display will indicate that it is sending the PIN to AlarmNet for verification.

■ Ethernet Fault

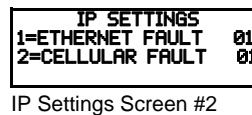

The Ethernet Fault Time is the duration of the communication loss between the FACP and the ethernet infrastructure.

Pressing 1 on the IP Settings Screen #2 will display the following:



Select the number of minutes allowed, 1-60, before a fault is shown on the panel.

■ Cellular Fault

The Cellular Fault Time is the duration of the communication loss between the FACP and the cellular infrastructure (e.g. cell tower).

Pressing 2 on the IP Settings Screen #2 will display the following:



Select the number of minutes allowed, 1-60, before a fault is shown on the panel.

Primary and Secondary Communication Paths



Communicator Screen #1

The Primary and Secondary Communication Path screens are used to configure the methods (primary and backup) for reporting to central station. Pressing 1 for *Pri* or 2 for *Sec* will display the following screens.

Note that the following information must be entered for both the Primary and Secondary Communication Paths.



Comm Path Screen

■ POTS



Comm Path Screen #1

To configure the communication method to contact central station as a telephone line, select 1 for *POTS*. The following screens will display.



POTS (XXX) Path Screen #1



POTS (XXX) Path Screen #2



POTS (XXX) Path Screen #3

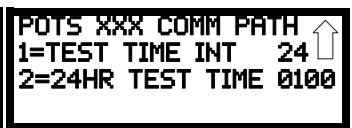

POTS (XXX) Path Screen #3

Enable

To enable the phone line, press 1 while viewing the POTS Line (X) Screen #1 to change the display to *Enabled Yes*. Each press of the 1 key will cause the display to toggle between *Enabled Yes* and *Enabled No*.



NOTE: For UL applications: when POTS is used as the primary transmission path, the use of POTS as the secondary transmission path is only allowed with approval of the local AHJ.

Account Code



POTS Comm Path Screen #1

Pressing 3 while viewing POTS (XXX) Path Screen #1 will cause the following screen to be displayed:



Account Codes Screen

The Account Code, which is assigned by a Central Station, depends on the communication format being used. The Account Code screen will have a flashing cursor in the lower left corner. Enter the supplied account code using 0 - 9 and A - F keys.

Phone Number



POTS Comm Path Screen #2

Pressing 2 while viewing POTS XXX Path Screen #2 will cause the following screen to be displayed:



Phone Numbers Screen

The Phone Number screen is used to enter the Central Station phone number that the Communicator will be contacting. A maximum of 20 characters can be entered with valid entries being 0 - 9 and A - C where A = *, B = # and C = 2 seconds pause.

A flashing cursor will appear in the lower left corner of the screen. Enter the first digit then press the right arrow key to move the cursor to the right one position. Enter the second digit and repeat the process until all digits are entered. Press the *Enter* key to store the phone number in memory.

Communication Format



POTS Comm Path Screen #3

Pressing 1 while viewing Primary/Secondary Screen #3 will cause the following screen to be displayed:

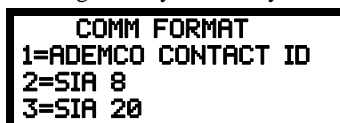

The Communication Format is determined by the type of receiver that the Communicator is transmitting to. Consult your Central Station for proper selection or consult our factory representatives. For any format chosen, the control panel automatically programs all of the event codes.

Select the Communication Format by pressing the corresponding number key while viewing the Comm Format screen. The following table describes each format:

Screen Selection	Communication Format Description
ADEMCO CONTACT ID	Contact ID, DTMF, 1400/2300 ACK
SIA 8	Security Industry Association, 8 messages per call
SIA 20	Security Industry Association, 20 messages per call

Table 3.2 Communication Formats

Test Time Interval



POTS Comm Path Screen #4

Pressing 1 while viewing POTS (XXX) Comm Path #4 will cause the following screens to be displayed:



Test Time Interval Screen #1



Test Time Interval Screen #2

The test report sent to the Central Station phone number may be sent once every 6, 8, 12, or 24 hours. Select the desired Test Time Interval by pressing the corresponding digit in the screens shown above. Refer to the table on page 46 for permissible settings.

24 Hour Test Time



POTS Comm Path Screen #4

Pressing 2 while viewing POTS (XXX) Comm Path #4 will cause the following screen to be displayed:

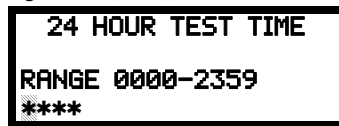

24 Hour Test Time Screen

Use the 24 Hour Test Time screen to program the time that the Communicator will transmit the 24 Hour Test to the Central Station. A flashing cursor will appear in the lower left corner of the screen. Enter a four digit number representing the test time using military time (0000 = midnight and 2359 = 11:59PM).

Ethernet



Comm Path Screen #1

To configure the communication method to contact central station as an ethernet connection, select 2 for Ethernet from the Comm Path Screen. The following screens will display.



Ethernet Options Screen #1



Ethernet Options Screen #2

Enable

To enable the Ethernet connection, press 1 while viewing the Ethernet Options Screen #1 to change the display to *Enabled Yes*. Each press of the 1 key will cause the display to toggle between *Enabled Yes* and *Enabled No*.

Central Station Account



Ethernet Options Screen #1

Press 2 on Ethernet Options Screen #1 to display the following:



Central Station Account Screen

Enter the *City ID*, *Central Station ID*, and *Account Code* all provided by the monitoring station..



NOTE: When using Ethernet as the primary and Cellular as secondary, the three CS account codes must be the same for both paths.

Supervision Settings



Ethernet Options Screen #2
used.

Pressing *1* while viewing Ethernet Options Screen #2 will cause the display to toggle between the 4 supervision setting options. Toggle to select *NFPA 2010 Sole Path*, *NFPA 2010 Dual Path*, *NFPA 2013 Sole Path*, or *NFPA 2013 Dual Path*. Refer to the table on page 46 for permissible settings.

The Supervision Interval is the time from the check-in at AlarmNet to the FACP. Select *Dual Path* when Ethernet and Cellular communications will be used. Select *Sole Path* when only Ethernet or Cellular is

- NFPA 2010 Dual Path: Supervision Interval: 24 Hours
- NFPA 2010 Sole Path: Supervision Interval: 5 min
- NFPA 2013 Dual Path: Supervision Interval: 6 Hours
- NFPA 2013 Sole Path: Supervision Interval: 1 Hour



NOTE: These supervision settings apply to both the Cellular settings and the Ethernet settings.

Cellular



Comm Path Screen #1

To configure the communication method to contact central station as a GSM/Cellular connection, select *3* for *Cellular* from the Comm Path Screen. The following screens will display. Note that a CELL-MOD or CELL-CAB-N must be installed in the system to use this feature.



Cellular Options Screen #1

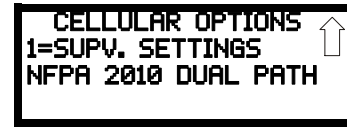

Cellular Options Screen #2

Enable

To enable the Ethernet connection, press *1* while viewing the Ethernet Options Screen #1 to change the display to *Enabled Yes*. Each press of the *1* key will cause the display to toggle between *Enabled Yes* and *Enabled No*.

Central Station Account



Cellular Options Screen #1

Press *2* on Cellular Options Screen #1 to display the following:



Central Station Account Screen

Enter the *City ID*, *Central Station ID*, and *Account Code* all provided by the monitoring station.

Supervision Settings



Ethernet Options Screen #2
used.

Pressing *1* while viewing Ethernet Options Screen #2 will cause the display to toggle between the 4 supervision setting options. Toggle to select *NFPA 2010 Sole Path*, *NFPA 2010 Dual Path*, *NFPA 2013 Sole Path*, or *NFPA 2013 Dual Path*. Refer to the table on page 46 for permissible settings.

The Supervision Interval is the time from the check-in at AlarmNet to the FACP. Select *Dual Path* when Ethernet and Cellular communications will be used. Select *Sole Path* when only Ethernet or Cellular is

- NFPA 2010 Dual Path: Supervision Interval: 24 Hours
- NFPA 2010 Sole Path: Supervision Interval: 5 min
- NFPA 2013 Dual Path: Supervision Interval: 6 Hours
- NFPA 2013 Sole Path: Supervision Interval: 1 Hour



NOTE: These supervision settings apply to both the Cellular settings and the Ethernet settings.

Trouble Report Limit (Dialer Runaway Prevention)



Communicator Screen #2

The Report Limit option limits the number of Communicator trouble calls to the Central Station, to a programmed amount between 0 and 99, for each unique trouble within a 24 hour period. Separate limit counters keep track of each unique type of trouble. Note that the number of phone line (communication) faults called to the Central Station are not limited by this feature. No subsequent restoral message is sent to the Central Station(s) for a particular trouble whose call limit has been reached. Local communicator annunciation will still track the particular trouble and restoral.

To set the Trouble Report Limit, press 3 while viewing Communicator Screen #1. The following screen will be displayed.



Trouble Report Limit Screen

Enter a value between 00 and 99, then press Enter to set the Report Limit to this value. Refer to the table on page 46 for permissible settings.



NOTE: Entering a value of 00 will disable the Trouble Report Limit allowing the Communicator to call the Central Station an unlimited number of times.

Report Style



Communicator Screen #3

Pressing 1 while viewing Communicator Screen #3 will cause the Report Style display to toggle between *Point* and *Zone*. Setting the Report Style to Point will program the Communicator to report individual point status to the Central Station. The control panel is capable of monitoring a total of 50 addressable devices. Setting the Report Style to Zone will program the Communicator to report zone status to the Central Station. The control panel is capable of monitoring a total of 20 individual zones.



NOTE:

1. Detector/Module Address 001 will be reported to the Central Station as Point 001.
2. Detector/Module Address 002 will be reported to the Central Station as Point 002 with reports continuing in a similar fashion up to Detector/Module Address 50 which will be reported as Point 50.

Event Codes



Communicator Screen #3

Pressing 2 while viewing the Communicator Screen #3 will cause the following screen to be displayed:



Event Code Screen

Select the desired communication format to update Event Code programming.



Event Code Screen

Pressing the down arrow key allows viewing of all Events associated with the selected Communication Format. Pressing the number corresponding to the event displayed in each screen will display its default event code which can be customized by the programmer. For example, pressing 1 for Pull Station will display the following screen which allows the Event Code to be changed from the default value.



Event Code Screen

The tables on the following pages list all of the Events and their default Event Codes for the various Communication Formats.

The information shown in Table 3.3 is automatically programmed for the Central Station phone number Event Codes when the Ademco Contact ID or SIA Format is selected. Enter 0s for an Event Code Setting to disable the report. Disabled reports will not get called to the Central Station. The programmer may enable the Event Types in programming as described on the previous page.

Event Description	Ademco Contact ID			SIA	
	Active	Zone	Point	Active	Restoral
PULL STATION	115	Zone	Point	FA	FH
MON-USER-DEF-1	115	Zone	Point	FA	FH
WATERFLOW	113	Zone	Point	SA	SH
MON-USER-DEF-2	113	Zone	Point	SA	SH
SMOKE (PHOTO)	111	Zone	Point	FA	FH
DET-USER-DEF-1	111	Zone	Point	FA	FH
SMOKE (ION)	111	Zone	Point	FA	FH

Table 3.3 Event Codes

DET-USER-DEF-2	111	Zone	Point	FA	FH
HEAT DETECT	114	Zone	Point	KA	KH
DET-USER-DEF-3	114	Zone	Point	KA	KH
SMOKE DUCT-P	116	Zone	Point	FA	FH
DET-USER-DEF-4	116	Zone	Point	FA	FH
PHOTO W/HEAT	111	Zone	Point	FA	FH
DET-USER-DEF-5	111	Zone	Point	FA	FH
CO ALARM	162	Zone	Point	GA	GH
DET-USER-DEF-6	200	Zone	Point	FS	FV
DUCT SUPERVISORY	200	Zone	Point	FS	FV
DET-USER-DEF-7	200	Zone	Point	FS	FV
PHOTO SUPER AR	200	Zone	Point	FS	FV
DET-USER-DEF-8	111	Zone	Point	FA	FH
CO SUPERVISORY	200	Zone	Point	GS	GV
DET-USER-DEF-9	111	Zone	Point	FA	FH
PHOTO ADAPT	111	Zone	Point	FA	FH
DET-USER-DEF-10	111	Zone	Point	FA	FH
PHOTO BEAM	111	Zone	Point	FA	FH
DET-USER-DEF-11	111	Zone	Point	FA	FH
MONITOR	110	Zone	Point	FA	FH
MON-USER-DEF-3	110	Zone	Point	FA	FH
SMOKE CONVEN	111	Zone	Point	FA	FH
MON-USER-DEF-5	111	Zone	Point	FA	FH
HEAT CONVENTIONAL	114	Zone	Point	KA	KH
MON-USER-DEF-6	114	Zone	Point	KA	KH
MEDIC ALERT	100	Zone	Point	MA	MH
MON-USER-DEF-7	100	Zone	Point	MA	MH
HAZARD ALERT	150	Zone	Point	PA	PH
MON-USER-DEF-8	150	Zone	Point	PA	PH
TORNADO ALRT	150	Zone	Point	PA	PH
MON-USER-DEF-9	150	Zone	Point	PA	PH
TAMPER	144	Zone	Point	TA	TH
MON-USER-DEF-11	144	Zone	Point	TA	TH
MON SUPERVISORY	200	Zone	Point	FS	FV
MON-USER-DEF-12	200	Zone	Point	FS	FV
MON SUPERV AUTO	200	Zone	Point	FS	FV
MON-USER-DEF-13	200	Zone	Point	FS	FV
HVAC OVERRIDE	200	Zone	Point	FS	FV
POWER MON	330	Zone	Point	AT	AR
MON-USER-DEF-14	330	Zone	Point	AT	AR
TROUBLE MON	POINT_FAULT code will always be transmitted				
MON-USER-DEF-15	POINT_FAULT code will always be transmitted				
PROCESS MON	000	Zone	Point	00	00
MON-USER-DEF-16	000	Zone	Point	00	00
PROC MON AR	000	Zone	Point	00	00
MON-USER-DEF-17	000	Zone	Point	00	00
POINT FAULT	380	Zone	Point	FT	FJ
POINT DISABLE	570	Zone	Point	FB	FU
MANUAL EVACUATION	110	000	000	00	00
AC_FAIL	301	000	000	AT	AR
DRILL	604	000	000	FI	FK

Table 3.3 Event Codes (Continued)

SLC 1 SHORT A	372	000	000	ET	ER
SLC 1 SHORT B	372	000	000	ET	ER
SLC 1 OPEN A	371	000	000	ET	ER
SLC 1 OPEN B	371	000	000	ET	ER
SLC 1 GND FAULT POS	310	000	000	ET	ER
SLC 1 GND FAULT NEG	310	000	000	ET	ER
SLC 1 COMM FAULT	330	000	000	EM	EN
SLC 1 OPEN FAULT	371	000	000	ET	ER
SLC 1 SHORT FAULT	372	000	000	ET	ER
GROUND FAULT	310	000	000	ET	ER
LOW BATTERY	302	000	000	YT	YR
NO_BATTERY	311	000	000	YT	YR
TELCO LINE 1	351	000	000	LT	LR
TELCO LINE 2	352	000	000	LT	LR
COMM FAULT 1	354	001	001	YC	YK
COMM FAULT 2	354	002	002	YC	YK
TOTAL COMM FAULT	000	N/A	N/A	00	00
ETHERNET FAULT	350	000	000	YS	YK
CELLULAR FAULT	350	000	000	YS	YK
PRINTER FAULT	336	000	000	VT	VR
NAC 1 FAULT	321	001	001	YA	YR
NAC 2 FAULT	322	002	002	YA	YR
24 VDC FAULT	300	000	000	YP	YQ
ACS FAULT	333	000	000	EM	EN
LCD-80F FAULT	330	000	000	EM	EN
PRI ANN-BUS FAULT	333	000	000	ET	ER
SEC ANN-BUS FAULT	333	000	000	ET	ER
PRI ANN CLASS A	333	000	000	ET	ER
REMOTE SYNC DIS	520	000	000	ET	ER
NAC 1 DISABLE	521	001	001	ET	ER
NAC 2 DISABLE	522	002	002	ET	ER
MEMORY FAULT	304	000	000		
CHARGER FAULT	300	000	000	YP	YQ
OPTION CARD 1 FAULT	331	000	000	ET	ER
REMOTE SYNC FAULT	300	000	000	OU	OV
ZONE DISABLE	570	000	000	FB	FU
AUX 1 CLASS A FAULT	300	000	000	YP	YQ
ANN-BUS COMM FAULT	333	000	000	ET	ER
DISPLAY COMM FAULT	300	000	000	ET	ER
NO_DEVICES_INSTLLD	380	000	000	ET	ER
OFF_NORMAL_MESSAGE	308	000	000	LB	LX
24_HOUR_TEST	602	000	000	RP	
24 HOUR ABNORMAL TES	608	000	000	RY	
UPDOWN REQUEST	411	000	000	RB	
UPLOAD SUCCESS	416	000	000	RS	
DOWNLOAD SUCCESS	412	000	000	RS	
UPDOWN FAILURE	413	000	000	RR	
GENERAL ALARM	000	000	000	00	00
GENERAL SUPERVISORY	000	000	000	00	00

Table 3.3 Event Codes (Continued)

3.6.8 Annunciators



Pressing 3 while viewing Programming Screen #3 will cause the control panel to display the following screens:

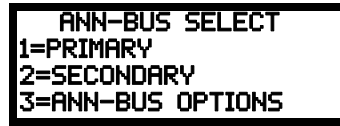

A printer module, graphic annunciator module, LCD annunciator module, LED annunciator module, and relay module can be programmed into the NFW-50X system. These devices communicate with the FACP over the ANN-BUS terminals on the control panel.

ANN-BUS Setup

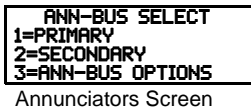

Two ANN-BUS circuits are available on the NFW-50X. Press 1 to configure the Primary ANN-BUS or press 2 to configure the Secondary ANN-BUS. The following screens will be displayed for either ANN-BUS circuit where (XXX) indicates either *Primary* or *Secondary*.



ANN-BUS Screen #1



ANN-BUS Screen #2

■ ANN-BUS Enabled

The ANN-BUS must be enabled if any modules are connected to the ANN-BUS terminals. To enable the ANN-BUS, press 1 while viewing ANN-BUS screen #1 so that the display reads *ANN (XXX) Enabled Yes*. Each press of the 1 key will cause the display to toggle between *ANN (XXX) Enabled Yes* and *ANN (XXX) Enabled No*.

■ Modules Installed

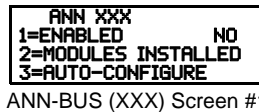

ANN-BUS (XXX) Screen #1

If an ANN-BUS module is installed, press 2 for *Modules Installed* to select ANN-BUS addresses for the module(s). The only difference between the two programming screens are the addresses. The Primary Bus module addresses will have a prefix of "1-" while the Secondary Bus module addresses will have a prefix of "2-". The following screen will be displayed for either bus circuit.

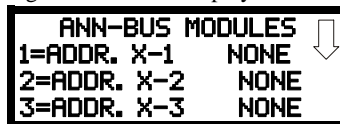

ANN-BUS Modules Screen #1

Pressing the down arrow key will allow the programmer to view additional screens displaying Addresses 1-8. To select one or more addresses for the installed module(s), press the number key corresponding to the module address in each screen. The following screen will be displayed for each address:



ANN-BUS Address Screen

Pressing 1 for *Type* will display the following screens:

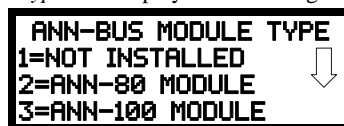

Module Type Screen #1

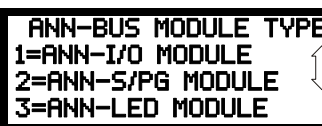

Module Type Screen #2



Module Type Screen #3

Press the number corresponding to the module/device type that is installed with the selected address.



NOTE: If the module type selected is the *ANN-80*, *ANN-100*, or *ANN-S/PG*, or if *Not Installed* is selected, the ANN-BUS Address Screen shown on the previous page will be displayed following the module selection. The options selected for each of these modules will be the same for all modules of the same type (refer to "*ANN-S/PG (Print) Options*" on page 94 and "*ANN-80/100 Options*" on page 94).

If ANN-I/O, ANN-LED, or ANN-RLY is the selected module type, the following ANN-BUS Address Screen will be displayed:

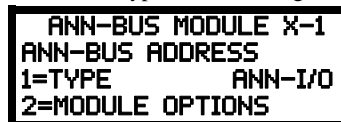

ANN-BUS Address Screen

Since the options for each of these module types can be individually set, pressing 2 for *Module Options*, while viewing the ANN-BUS Address Screen will display the available options as described below.

ANN-I/O Options

Pressing 2 for Module Options while viewing ANN-BUS Address screen when the ANN-I/O option is selected will display the following screen:

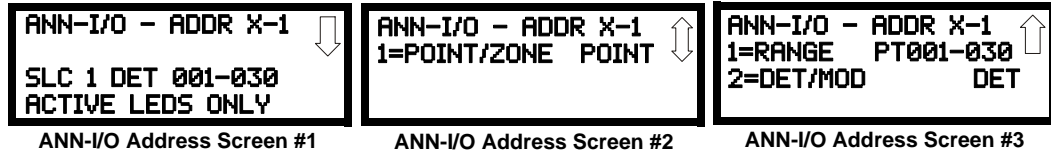

Pressing 1 while viewing the ANN-I/O Address Screen #2 will program the annunciator module to annunciate either Point (addressable device address) information or Zone information. Each press of the 1 key will toggle the display between *Zone* and *Point*.

Pressing 1 while viewing the ANN-I/O Address Screen #3 will select the Point range to be annunciated (refer to the tables in “ANN-I/O Zone Option” on page 88 and “ANN-I/O Point Option” on page 89). If Point has been selected, each press of the 2 key for *Range* will change the points to be annunciated with the options being 001 - 030 and 031 - 050.

Pressing 2 while viewing ANN-I/O Address Screen #3 will select either addressable detectors or addressable modules to be annunciated.

ANN-I/O Zone Option

If *Zone* is selected as the module option, the first ten LEDs on the first N-ANN-I/O module will display the system status information. The remaining 30 LEDs on the first module and 20 LEDs on the second module will display the active/alarm status of each zone in the Zone Range programmed for that particular module. The LED assignments for the N-ANN-I/O module will be as follows.

Module LED	Zone Range 000-029	Zone Range 030-049
1	AC Fault	Zone 030
2	Fire Alarm	Zone 031
3	Supervisory	Zone 032
4	Trouble	Zone 033
5	Alarm Silenced	Zone 034
6	Earth Fault	Zone 035
7	Battery Fault	Zone 036
8	Charger Fault	Zone 037
9	NAC Fault	Zone 038
10	Disabled	Zone 039
11	Zone 000	Zone 040
12	Zone 001	Zone 041
13	Zone 002	Zone 042
14	Zone 003	Zone 043
15	Zone 004	Zone 044
16	Zone 005	Zone 045
17	Zone 006	Zone 046
18	Zone 007	Zone 047
19	Zone 008	Zone 048
20	Zone 009	Zone 049
21	Zone 010	Not Used
22	Zone 011	Not Used
23	Zone 012	Not Used
24	Zone 013	Not Used
25	Zone 014	Not Used
26	Zone 015	Not Used
27	Zone 016	Not Used
28	Zone 017	Not Used
29	Zone 018	Not Used
30	Zone 019	Not Used
31	Zone 020	Not Used
32	Zone 021	Not Used
33	Zone 022	Not Used
34	Zone 023	Not Used
35	Zone 024	Not Used
36	Zone 025	Not Used
37	Zone 026	Not Used
38	Zone 027	Not Used
39	Zone 028	Not Used
40	Zone 029	Not Used

ANN-I/O Point Option



If *Point* is selected as the module option, the first ten LED driver outputs on the first N-ANN-I/O module will display the system status information. The remaining 30 LED driver outputs on the first module and 20 LEDs on the second module will display the active/alarm status of each point in the Point Range programmed for that particular module. The points that will be annunciated on a particular N-ANN-I/O module depend on the programming options selected as far as the device type (detector or module) to be annunciated. The LED assignments for each N-ANN-I/O module will be as follows.

Module LED	ANN-I/O Module #1 Function	ANN-I/O Module #2 Function
1	AC Fault	Not Used
2	Fire Alarm	Not Used
3	Supervisory	Not Used
4	Trouble	Not Used
5	Alarm Silenced	Not Used
6	Not Used	Not Used
7	Not Used	Not Used
8	Not Used	Not Used
9	Not Used	Not Used
10	Not Used	Not Used
11	Point 001 - Active/Alarm	Point 031 - Active/Alarm
12	Point 002 - Active/Alarm	Point 032 - Active/Alarm
13	Point 003 - Active/Alarm	Point 033 - Active/Alarm
14	Point 004 - Active/Alarm	Point 034 - Active/Alarm
15	Point 005 - Active/Alarm	Point 035 - Active/Alarm
16	Point 006 - Active/Alarm	Point 036 - Active/Alarm
17	Point 007 - Active/Alarm	Point 037 - Active/Alarm
18	Point 008 - Active/Alarm	Point 038 - Active/Alarm
19	Point 009 - Active/Alarm	Point 039 - Active/Alarm
20	Point 010 - Active/Alarm	Point 040 - Active/Alarm
21	Point 011 - Active/Alarm	Point 041 - Active/Alarm
22	Point 012 - Active/Alarm	Point 042 - Active/Alarm
23	Point 013 - Active/Alarm	Point 043 - Active/Alarm
24	Point 014 - Active/Alarm	Point 044 - Active/Alarm
25	Point 015 - Active/Alarm	Point 045 - Active/Alarm
26	Point 016 - Active/Alarm	Point 046 - Active/Alarm
27	Point 017 - Active/Alarm	Point 047 - Active/Alarm
28	Point 018 - Active/Alarm	Point 048 - Active/Alarm
29	Point 019 - Active/Alarm	Point 049 - Active/Alarm
30	Point 020 - Active/Alarm	Point 050 - Active/Alarm
31	Point 021 - Active/Alarm	Not Used
32	Point 022 - Active/Alarm	Not Used
33	Point 023 - Active/Alarm	Not Used
34	Point 024 - Active/Alarm	Not Used
35	Point 025 - Active/Alarm	Not Used
36	Point 026 - Active/Alarm	Not Used
37	Point 027 - Active/Alarm	Not Used
38	Point 028 - Active/Alarm	Not Used
39	Point 029 - Active/Alarm	Not Used
40	Point 030 - Active/Alarm	Not Used

ANN-LED Options

```
ANN XXX
1=ENABLED      YES
2=MODULES INSTALLED
3=AUTO-CONFIGURE
ANN-BUS XXX Screen #2
```

Pressing 2 for Module Options while viewing the ANN XXX Address Screen when the ANN-LED option is selected, will display the following screens:

 <p>ANN-LED - ADDR X-1 ZONES 000-009 ALARM, TRBL, SUPV</p>	 <p>ANN-LED - ADDR X-1 1=POINT/ZONE ZONE 2=ALARM/ATS ATS</p>	 <p>ANN-LED - ADDR X-1 1=RANGE ZN000-009</p>
ANN-LED Address Screen #1	ANN-LED Address Screen #2	ANN-LED Address Screen #3

The first screen indicates that the N-ANN-LED at the selected ANN-BUS address is programmed to annunciate Alarms, Troubles and Supervisories for Zones 000 through 009. The programming can be changed using ANN-LED Address Screen 2.

Pressing 1 while viewing ANN-LED Address Screen #2 will program the annunciator module to annunciate either Point (addressable device address) information or Zone information. Each press of the 1 key will toggle the display between *Point* and *Zone*.

Pressing 2 while viewing ANN-LED Address Screen #2 will program the annunciator module to annunciate only Alarms or Alarms, Troubles and Supervisories (ATS). Each press of the 2 key will toggle the display between *Alarms* and *ATS*.

Pressing 1 while viewing ANN-LED Address Screen #3 will select the Point or Zone range to be annunciated (refer to the tables in “**N-ANN-RLED Zone Option - Alarm Only**” on page 90 and “**N-ANN-RLED Point Option - Alarm Only**” on page 91). Pressing the 1 key will display an additional screen where the range can be selected.

- If Zone has been selected, and Alarms Only are to be annunciated, the new screen will give the options of annunciating Zone 000 - 029 or 030 - 049. Two N-ANN-LED modules are required to annunciate all zones in this configuration.
- If Zone has been selected, and Alarms, Troubles and Supervisories are to be annunciated, the new screen will give the options of annunciating Zone 000 - 009, 010 - 019, 020 - 029, 030 - 039, or 040 - 049. Five N-ANN-LED modules are required to annunciate all zones in this configuration.
- If Points has been selected, and Alarms Only are to be annunciated, the new screen will give the options of annunciating Points 001 - 030 and 031 - 050. Two N-ANN-LED modules are required to annunciate all points in this configuration.
- If Point has been selected, and Alarms, Troubles and Supervisories are to be annunciated, the new screens will give the options of annunciating Points 001 - 010, 011 - 020, 021 - 030, 031 - 040 or 041 - 050. Five N-ANN-LED modules are required to annunciate all points in this configuration.

N-ANN-RLED Zone Option - Alarm Only

If *Zone* is selected as the module option, and the module is programmed to annunciate **alarms only**, the first ten LEDs on the N-ANN-RLED module will display the system status information. The remaining 30 LEDs on the first module and the last 30 LEDs on the second module will display the active/alarm status of each zone in the Zone Range programmed for that particular module. The LED assignments for each N-ANN-LED module will be as follows.

Alarm Silenced	NAC 1 Fault	NAC 2 Fault	Not Used	Not Used
Earth Fault	Battery Fault	Charger Fault	Disabled	Maintenance
Zone 000 Active/Alarm	Zone 001 Active/Alarm	Zone 002 Active/Alarm	Zone 003 Active/Alarm	Zone 004 Active/Alarm
Zone 005 Active/Alarm	Zone 006 Active/Alarm	Zone 007 Active/Alarm	Zone 008 Active/Alarm	Zone 009 Active/Alarm
Zone 010 Active/Alarm	Zone 011 Active/Alarm	Zone 012 Active/Alarm	Zone 013 Active/Alarm	Zone 014 Active/Alarm
Zone 015 Active/Alarm	Zone 016 Active/Alarm	Zone 017 Active/Alarm	Zone 018 Active/Alarm	Zone 019 Active/Alarm
Zone 020 Active/Alarm	Zone 021 Active/Alarm	Zone 022 Active/Alarm	Zone 023 Active/Alarm	Zone 024 Active/Alarm
Zone 025 Active/Alarm	Zone 026 Active/Alarm	Zone 027 Active/Alarm	Zone 028 Active/Alarm	Zone 029 Active/Alarm

Table 3.4 N-ANN-RLED Module #1

Not Used	Not Used	Not Used	Not Used	Not Used
Not Used	Not Used	Not Used	Not Used	Not Used
Zone 030 Active/Alarm	Zone 031 Active/Alarm	Zone 032 Active/Alarm	Zone 033 Active/Alarm	Zone 034 Active/Alarm
Zone 035 Active/Alarm	Zone 036 Active/Alarm	Zone 037 Active/Alarm	Zone 038 Active/Alarm	Zone 039 Active/Alarm
Zone 040 Active/Alarm	Zone 041 Active/Alarm	Zone 042 Active/Alarm	Zone 043 Active/Alarm	Zone 044 Active/Alarm
Zone 045 Active/Alarm	Zone 046 Active/Alarm	Zone 047 Active/Alarm	Zone 048 Active Alarm	Zone 049 Active/Alarm
Not Used	Not Used	Not Used	Not Used	Not Used
Not Used	Not Used	Not Used	Not Used	Not Used

Table 3.5 N-ANN-RLED Module #2

N-ANN-LED Zone Option - Alarm, Trouble and Supervisory

If *Zone* is selected as the module option, and the module is programmed to annunciate **alarms, troubles and supervisories**, the first ten LEDs on the first N-ANN-LED module will display the system status information. The remaining 30 LEDs on the first module and the last 30 LEDs on the remaining modules will display the alarm, trouble and supervisory status for each of the ten zones in the Zone Range programmed for that particular module. The LED assignments for each N-ANN-LED module will be as follows.

Alarm Silenced	NAC 1 Fault	NAC 2 Fault	NAC 3 Fault	NAC 4 Fault
Earth Fault	Battery Fault	Charger Fault	Disabled	Maintenance
Zone 000 Active/Alarm	Zone 001 Active/Alarm	Zone 002 Active/Alarm	Zone 003 Active/Alarm	Zone 004 Active/Alarm
Zone 000 Trouble	Zone 001 Trouble	Zone 002 Trouble	Zone 003 Trouble	Zone 004 Trouble
Zone 000 Supervisory	Zone 001 Supervisory	Zone 002 Supervisory	Zone 003 Supervisory	Zone 004 Supervisory
Zone 005 Active/Alarm	Zone 006 Active/Alarm	Zone 007 Active/Alarm	Zone 008 Active Alarm	Zone 009 Active/Alarm
Zone 005 Trouble	Zone 006 Trouble	Zone 007 Trouble	Zone 008 Trouble	Zone 009 Trouble
Zone 005 Supervisory	Zone 006 Supervisory	Zone 007 Supervisory	Zone 008 Supervisory	Zone 009 Supervisory

Table 3.6 N-ANN-LED Module #1

Not Used	Not Used	Not Used	Not Used	Not Used
Not Used	Not Used	Not Used	Not Used	Not Used
Zone 010 Active/Alarm	Zone 011 Active/Alarm	Zone 012 Active/Alarm	Zone 013 Active/Alarm	Zone 014 Active/Alarm
Zone 010 Trouble	Zone 011 Trouble	Zone 012 Trouble	Zone 013 Trouble	Zone 014 Trouble
Zone 010 Supervisory	Zone 011 Supervisory	Zone 012 Supervisory	Zone 013 Supervisory	Zone 014 Supervisory
Zone 015 Active/Alarm	Zone 016 Active/Alarm	Zone 017 Active/Alarm	Zone 018 Active/Alarm	Zone 019 Active/Alarm
Zone 015 Trouble	Zone 016 Trouble	Zone 017 Trouble	Zone 018 Trouble	Zone 019 Trouble
Zone 015 Supervisory	Zone 016 Supervisory	Zone 017 Supervisory	Zone 018 Supervisory	Zone 019 Supervisory

Table 3.7 N-ANN-LED Module #2

The LED assignments for the modules annunciating Zone Ranges 020 - 029, 030 - 039, and 040 - 049 will follow the same pattern as the second N-ANN-LED module.

N-ANN-RLED Point Option - Alarm Only

If *Point* is selected as the module option and the module is programmed to annunciate **alarms** only, the first ten LEDs on the first N-ANN-RLED module will display the system status information. The remaining 30 LEDs on the first module and LEDs 11 - 30 on the second module will display the active/alarm status of each point in the Point Range programmed for that particular module. The LED assignments for each N-ANN-RLED module will be as follows.

First N-ANN-RLED Module (Point Range 001 - 030)				
Alarm Silenced	NAC 1 Fault	NAC 2 Fault	Not Used	Not Used
Earth Fault	Battery Fault	Charger Fault	Disabled	Maintenance
Point 001 Active/Alarm	Point 002 Active/Alarm	Point 003 Active/Alarm	Point 004 Active/Alarm	Point 005 Active/Alarm
Point 006 Active/Alarm	Point 007 Active/Alarm	Point 008 Active/Alarm	Point 009 Active/Alarm	Point 010 Active/Alarm
Point 011 Active/Alarm	Point 012 Active/Alarm	Point 013 Active/Alarm	Point 014 Active/Alarm	Point 015 Active/Alarm
Point 016 Active/Alarm	Point 017 Active/Alarm	Point 018 Active/Alarm	Point 019 Active/Alarm	Point 020 Active/Alarm
Point 021 Active/Alarm	Point 022 Active/Alarm	Point 023 Active/Alarm	Point 024 Active/Alarm	Point 025 Active/Alarm
Point 026 Active/Alarm	Point 027 Active/Alarm	Point 028 Active/Alarm	Point 029 Active/Alarm	Point 030 Active/Alarm

Second N-ANN-LED Module (Point Range 031 - 050)				
Not Used	Not Used	Not Used	Not Used	Not Used
Not Used	Not Used	Not Used	Not Used	Not Used
Point 031 Active/Alarm	Point 032 Active/Alarm	Point 033 Active/Alarm	Point 034 Active/Alarm	Point 035 Active/Alarm
Point 036 Active/Alarm	Point 037 Active/Alarm	Point 038 Active/Alarm	Point 039 Active/Alarm	Point 040 Active/Alarm
Point 041 Active/Alarm	Point 042 Active/Alarm	Point 043 Active/Alarm	Point 044 Active/Alarm	Point 045 Active/Alarm
Point 046 Active/Alarm	Point 047 Active/Alarm	Point 048 Active/Alarm	Point 049 Active/Alarm	Point 050 Active/Alarm
Not Used	Not Used	Not Used	Not Used	Not Used
Not Used	Not Used	Not Used	Not Used	Not Used

N-ANN-LED Point Option - Alarm, Trouble and Supervisory

If *Point* is selected as the module option, and the module is programmed to annunciate **alarms, troubles and supervisories**, the first ten LEDs on the first N-ANN-LED module will display the system status information. The remaining 30 LEDs on the first module and the last 30 LEDs on the remaining modules will display the alarm, trouble and supervisory status for each of the ten points in the Point Range programmed for that particular module. The LED assignments for each N-ANN-LED module will be as follows.

First N-ANN-LED Module (Point Range 001 - 010)				
Alarm Silenced	NAC 1 Fault	NAC 2 Fault	Not Used	Not Used
Earth Fault	Battery Fault	Charger Fault	Disabled	Maintenance
Point 001 Active/Alarm	Point 002 Active/Alarm	Point 003 Active/Alarm	Point 004 Active/Alarm	Point 005 Active/Alarm
Point 001 Trouble	Point 002 Trouble	Point 003 Trouble	Point 004 Trouble	Point 005 Trouble
Point 001 Supervisory	Point 002 Supervisory	Point 003 Supervisory	Point 004 Supervisory	Point 005 Supervisory
Point 006 Active/Alarm	Point 007 Active/Alarm	Point 008 Active/Alarm	Point 009 Active/Alarm	Point 010 Active/Alarm
Point 006 Trouble	Point 007 Trouble	Point 008 Trouble	Point 009 Trouble	Point 010 Trouble
Point 006 Supervisory	Point 007 Supervisory	Point 008 Supervisory	Point 009 Supervisory	Point 010 Supervisory

Second N-ANN-LED Module (Point Range 011 - 020)				
Not Used	Not Used	Not Used	Not Used	Not Used
Not Used	Not Used	Not Used	Not Used	Not Used
Point 011 Active/Alarm	Point 012 Active/Alarm	Point 013 Active/Alarm	Point 014 Active/Alarm	Point 015 Active/Alarm
Point 011 Trouble	Point 012 Trouble	Point 013 Trouble	Point 014 Trouble	Point 015 Trouble
Point 011 Supervisory	Point 012 Supervisory	Point 013 Supervisory	Point 014 Supervisory	Point 015 Supervisory
Point 016 Active/Alarm	Point 017 Active/Alarm	Point 018 Active/Alarm	Point 019 Active/Alarm	Point 020 Active/Alarm
Point 016 Trouble	Point 017 Trouble	Point 018 Trouble	Point 019 Trouble	Point 020 Trouble
Point 016 Supervisory	Point 017 Supervisory	Point 018 Supervisory	Point 019 Supervisory	Point 020 Supervisory

The LED assignments for the modules annunciating Point Ranges 021 - 030, 031 - 040 and 041 - 050, will follow the same pattern as the second N-ANN-LED Module: third module Point Range 021 - 030, fourth module Point Range 031 - 040 and fifth module Point Range 041 - 050.

ANN-RLY Options

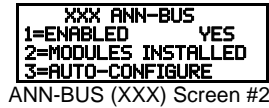

ANN-BUS (XXX) Screen #2

Pressing 2 for *Module Options* while viewing the ANN-BUS Address Screen when the ANN-RLY option is selected, will cause the following screen to be displayed:

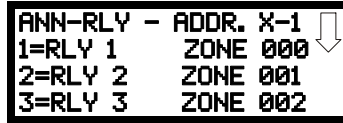

ANN-RLY Options Screen

The N-ANN-RLY module provides ten Form-C relays which can be programmed for various functions. The initial screen displays Relays 1 through 3. Pressing the down arrow key will display the remaining relays for this module.

To program any of the N-ANN-RLY relays, while viewing the appropriate ANN-RLY Option screen, press the number key corresponding to the relay to be programmed. Following is a list of the available programming options for each relay:

- Alarm
- Supervisory
- Supervisory AR
- Trouble
- Comm Fail
- Process Mon
- Process Mon AR
- AC Loss
- Hazard
- Medical
- Silenceable Alarm
- Zone Active XXX (where XXX = programmed zone 000 to 019)
- Carbon Monoxide

■ Auto-Configure

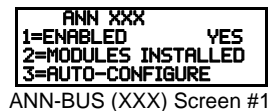

ANN-BUS (XXX) Screen #1

The ANN-BUS Auto-Configure features allows the programmer to quickly bring all installed ANN-BUS modules online on the selected ANN-BUS. The software will search the selected circuit for all ANN-BUS modules and automatically program the device type and address into the system. For the Auto-Configure to work, the selected ANN-BUS must be enabled, the annunciators must be connected/powered, and a unique address must be set on each annunciator. Pressing 3 while viewing ANN-BUS (XXX) Screen #1 will begin

the Auto-Configure process and cause the following screen to be displayed:

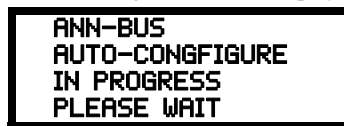

Auto-Configure Screen

■ Class A



ANN-BUS (XXX) Screen #2

This option applies to the Primary ANN-BUS only. The primary ANN-BUS can be configured for Class A wiring. If wired in Class A configuration, press 1 on ANN-BUS Primary Screen #2 to select *Class A Yes*. Each press of the 1 key toggles between *Class A No* and *Class A Yes*.

ANN-BUS Options

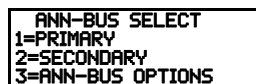

Annunciator Screen

Three ANN-BUS modules have more programming options. Pressing 3 while viewing the Annunciators screen will display the following.

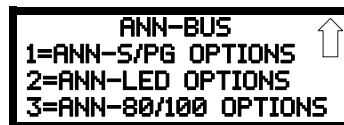

ANN-BUS Options Screen

■ ANN-S/PG (Print) Options

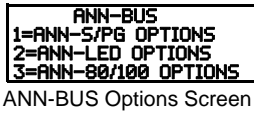

ANN-BUS Options Screen

The Print option allows the programmer to configure the optional printer. Pressing 1 while viewing the ANN-BUS Options screen will display the following screens:

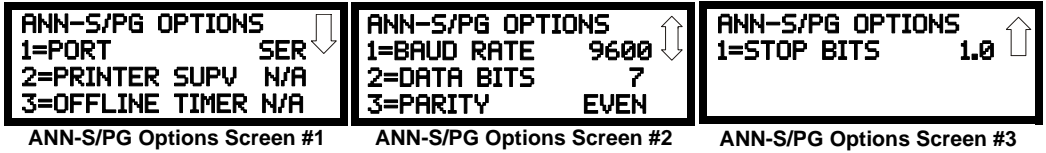

Pressing 1 for Port while viewing ANN-S/PG Options screen #1 will allow the programmer to select between a Parallel and Serial Port for printer connection. Each press of the 1 key will cause the display to toggle between *Port PAR* (parallel) and *Port SER* (serial). It is important to note that the interface selected determines which options are available to the user.

If the Parallel Port option is selected, the user has the option to supervise the printer and select an offline timer for the supervision by pressing 2 for Printer Supervision while viewing Print Options screen #1. Each press of the 2 key will cause the display to toggle between *Printer Supv NO* for no supervision and *Printer Supv YES* for printer supervision. Note that this option is not selectable if the Serial Port option has been selected.

If the Parallel Port option is selected, the user has the ability to select an *Offline Timer* by pressing 3 while viewing Print Options screen #1. The resultant screen allows the programmer to program the *Offline Timer* for a delay of between 0 and 255 seconds before loss of printer supervision is reported as a trouble.

If the Serial Port option is selected, the *Printer Supv* and *Offline Timer* options will not be available. The Baud Rate, Data Bits, Parity and Stop Bits options are only available when the Serial Port option has been selected.

Pressing 1 for *Baud Rate* while viewing ANN-S/PG Options screen #2 will cause a screen to appear which allow the user to select a Baud Rate of 19200, 9600, or 2400.

Pressing 2 for *Data Bits* while viewing ANN-S/PG Options screen #2 will cause a screen to appear which allows the user to select 7 or 8 *Data Bits*.

Pressing 3 for *Parity* while viewing ANN-S/PG Options screen #2 will cause a screen to appear which allows the user to select between *No Parity*, *Even Parity*, or *Odd Parity*.

Pressing 1 for *Stop Bits* while viewing ANN-S/PG Options screen #3 will cause a screen to appear which allows the user to select between 1.0 or 2.0 *Stop Bits*.

■ ANN-LED Options

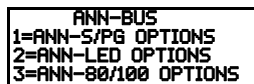

ANN-BUS Options Screen

This option allows the programmer to configure the optional N-ANN-LED annunciator. Pressing 2 while viewing the ANN-BUS screen will display the following screens.

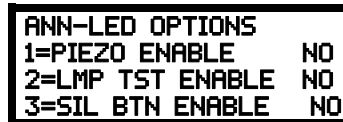

ANN-LED Options Screen

The *Piezo Enable* option allows the programmer to select whether the piezo sounder on any installed N-ANN-LED module will ever sound. Pressing 1 while viewing the ANN-LED Options Screen causes the display to toggle between *Piezo Enable Yes* and *Piezo Enable No*.

The *Lamp Test Enable (LMP TST ENABLE)* option allows the programmer to select whether the Lamp Test button on any installed N-ANN-LED annunciator will function normally or always be ignored. Pressing 2 while viewing the ANN-LED Options Screen causes the display to toggle between *Lmp Tst Enable Yes* (Lamp Test button functions normally) and *Lmp Tst Enable No* (Lamp Test button never functions).

The *Silence Button Enable (SIL BTN ENABLE)* option allows the programmer to select whether the Silence button on any installed N-ANN-LED annunciator will function normally or always be ignored. Pressing 3 while viewing the ANN-LED Options Screen causes the display to toggle between *Sil Btn Enable Yes* (Silence button functions normally) and *Sil Btn Enable No* (Silence button never functions).

■ ANN-80/100 Options



ANN-BUS Options Screen

Pressing 3 while viewing the ANN-BUS screen will display the following screen:

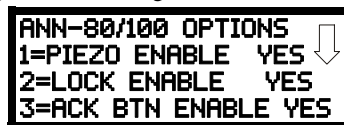

ANN-80/100 Options Screen #1

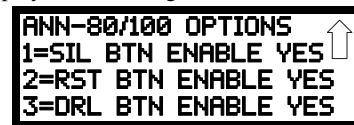

ANN-80/100 Options Screen #2

The *Piezo Enable* option allows the programmer to select whether the piezo sounder on any installed N-ANN-80 or N-ANN-100 module will ever sound. Pressing 1 while viewing the ANN-80/100 Options Screen #1 causes the display to toggle between *Piezo Enable Yes* and *Piezo Enable No*.

The *Lock Enable* option allows the programmer to select whether or not any installed N-ANN-80 or N-ANN-100 annunciator must be unlocked by its key before any annunciator key presses will function. Pressing 2 while viewing the ANN-80/100 Options Screen #1 causes the display to toggle between *Lock Enable Yes* (annunciator must be unlocked for keys to function) and *Lock Enable No* (lock position is ignored). Refer to the table on page 46 for permissible settings.

The Acknowledge Button Enable (*ACK BTN ENABLE*) option allows the programmer to select whether the Ack/Step button on any installed N-ANN-80 or N-ANN-100 annunciator will function normally or always be ignored. Pressing 3 while viewing the ANN-80/100 Options Screen #1 causes the display to toggle between *Ack Btn Enable Yes* (Ack/Step button functions normally) and *Ack Btn Enable No* (Ack/Step button never functions).

The Silence Button Enable (*SIL BTN ENABLE*) option allows the programmer to select whether the Silence button on any installed N-ANN-80 or N-ANN-100 annunciator will function normally or always be ignored. Pressing 1 while viewing the ANN-80/100 Options Screen #2 causes the display to toggle between *Sil Btn Enable Yes* (Silence button functions normally) and *Sil Btn Enable No* (Silence button never functions).

The Reset Button Enable (*RST BTN ENABLE*) option allows the programmer to select whether the Reset button on any installed N-ANN-80 or N-ANN-100 annunciator will function normally or always be ignored. Pressing 2 while viewing the ANN-80/100 Options Screen #2 causes the display to toggle between *Rst Btn Enable Yes* (Reset button functions normally) and *Rst Btn Enable No* (Reset button never functions).

The Drill Button Enable (*DRL BTN ENABLE*) option allows the programmer to select whether the Drill button on any installed N-ANN-80 or N-ANN-100 annunciator will function normally or always be ignored. Pressing 3 while viewing the ANN-80/100 Options Screen #2 causes the display to toggle between *Drl Btn Enable Yes* (Drill button functions normally) and *Drl Btn Enable No* (Drill button never functions).

3.6.9 Password Change



Programming Screen #4

The factory set passwords, which have been programmed into the control panel, can be changed by selecting the Password Change option. Pressing 1 while viewing Programming Screen #4 will cause the following screen to be displayed:



Password Change Screen

Press 1 to change the Master Programming Level password, 2 to change the Maintenance Level password or 3 to change the Remote Download password. *Note that the passwords will not be displayed on LCD annunciators.*

The following screen will appear when any change option is selected:



Enter Password Screen

A flashing cursor will appear in the center of the display. Enter a new eight digit password (such as 10101010 for the Master Level). After the eighth digit is entered, the following screen will be displayed:



Password Change Screen

Re-enter the new password to accept the change. The display will return to the initial Password Change Screen.

Invalid Password

If a password is entered incorrectly, the panel will display *Invalid Message* and a code.



Invalid Password Screen

The programmer may hit the escape key and re-enter the password correctly. However, if the password has been forgotten, record the 20-character code and contact NOTIFIER Technical Services. After proper authentication, the master password will be supplied to the programmer.

3.6.10 Clear Program



Programming Screen #4

Pressing 2 while viewing Programming Screen #4, will select the Clear Program option. This will cause the LCD to display the following screen:

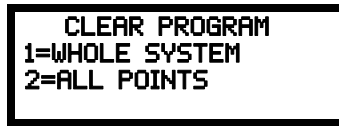

Clear Program Screen

Pressing 1, for Whole System while viewing the Clear Program Screen, will clear all general system programming options and all programmed addressable devices from the nonvolatile memory of the FACP. *This function is useful when the control panel is first installed, prior to autoprogramming. Note that it is necessary to autoprogram after using the Clear Whole System function.*

Pressing 2, for All Points while viewing the Clear Program Screen, will clear all programming related to the SLC loop and connected addressable devices.

Before executing any of the Clear commands listed above, the control panel will provide a warning to the user by prompting with the following display:

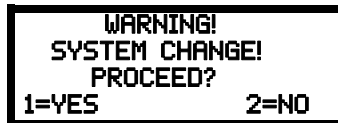

Pressing 1 will cause the control panel to carry out the selected clear option. Pressing 2 will prevent programming from being cleared.

3.6.11 Program Check



Programming Screen #4

The Program Check feature allows the programmer to view the zones which have been programmed to the Notification Appliance Circuits on the control panel but have not been programmed to Initiating Devices as well as other circuits with no input or output correlations. Pressing 3 while viewing Programming Screen #4 will cause the following screen to be displayed:

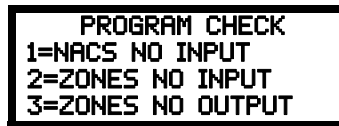

Program Check Screen

Pressing 1 while viewing the Program Check Screen will display an NAC screen similar to the following.



The example above indicates that NAC 1 has been programmed to Zones 005, 010, 012, 015, and 017 but no input devices have been programmed to any of these zones. Use the up and down arrow keys to view all the NAC zones without input assignments for NAC 1 and NAC 2.

Pressing 2 while viewing the Program Check Screen #1 will display a screen similar to the following:



The Zone No Input screen allows the programmer to view the zones which have not been programmed to at least one input device (not including general alarm Zone 00). The example in the preceding screen indicates that Zones 005, 007, 009, 010 and 011 have been programmed to an addressable module (control module in this example) with an address of 001 on loop 1 but have not been programmed to any input devices. Use the up and down arrow keys to view all the zones without input assignments.



Program Check Screen #1

Pressing 3 while viewing Program Check Screen #1 will cause a screen similar to the following to be displayed:



The Zone No Output feature allows the programmer to view the zones which have not been programmed to at least one output device (not including general alarm Zone 00). The example in the preceding screen indicates that Zones 05, 07, 09, 10 and 11 have been programmed to an addressable detector with an address of 001 on loop 1 but have not been programmed to any output devices. Use the up and down arrow keys to view all the zones without output assignments.

3.7 Maintenance Programming Level

To access Maintenance Programming mode, press the *Enter* key. The LCD will display the following:

```
1=READ STATUS MODE
2=PROGRAMMING MODE
3=FSTOOL UP/DOWNLOAD
4=USB UP/DOWNLOAD
```

To enter the Maintenance Programming mode, press 2. The display will read as follows:

```
PROGRAMMING
ENTER PASSWORD
```

When the **Maintenance** level password (default *1111111*) is entered, the following screen will appear:

```
MAINT PROGRAMMING
1=POINT PROGRAM
2=HISTORY
3=PROGRAM CHECK
```

Note that in the preceding screens, an arrow appears to inform the programmer that additional options can be viewed by pressing the keypad *down* arrow key, as shown in the following screen.

```
PROGRAMMING
1=WALKTEST
2=SYSTEM
3=ZONE SETUP
```

3.7.1 Disable Point

```
MAINT PROGRAMMING
1=POINT PROGRAM
2=HISTORY
3=PROGRAM CHECK
```

Maintenance Screen #1

Pressing 1 for Point Program, while viewing Maintenance Screen #1 will cause the following screens to be displayed:

```
POINT PROGRAM
1=DETECTOR
2=MODULE
```

Device Select Screen

Select the device type by pressing 1 for an addressable detector or 2 for an addressable module. The operator will be prompted to enter the three digit device address as shown in the following example for a detector:

```
EDIT DETECTOR
ENTER POINT ADDRESS
***
```

Address Select Screen

A flashing cursor will appear in the bottom left corner of the display, prompting for the three digit device address. When the third digit is enter, *001* for example, a screen will appear which will allow enabling or disabling of the selected point, as illustrated in the following example:

```
EDIT DETECTOR 1D001
1=ENABLED YES
```

Enable/Disable Select Screen

Pressing 1 repeatedly will cause the display to toggle between *Enabled Yes* and *Enabled No*.

3.7.2 History

```
MAINT PROGRAMMING
1=POINT PROGRAM
2=HISTORY
3=PROGRAM CHECK
```

Maintenance Screen #1

Pressing 2 while viewing Maintenance Screen #1 will cause the following screen to be displayed:

```
HISTORY
1=VIEW EVENTS
2=ERASE HISTORY
```

History Screen

The History feature allows the operator to view control panel events which have been stored in a history file in memory and erase the contents of the history file

Pressing *1* while viewing the History screen will cause the following screen to be displayed:

```

HISTORY
1=VIEW ALL
2=VIEW ALARMS
3=VIEW OTHER EVENTS
  
```

Events Screen

To view all the events which have occurred in the control panel since the history file was last erased, press *1* while viewing the Events screen. To view only alarms which have occurred, press *2* while viewing the Events screen. To view events other than alarms, press *3*. The most recent event will be displayed on the screen. To view all of the selected events, press the up or down arrow keys to scroll through the list of events. If no events have occurred, the display will read *NO EVENTS IN HISTORY*.

Pressing *2* while viewing the History Screen will cause the following screen to be displayed:

```

ERASE HISTORY
PROCEED ?
1=YES          2=NO
  
```

Erase History Screen

Pressing *1* while viewing the Erase History Screen will cause the message *ERASING HISTORY, PLEASE WAIT* to be displayed. The display will then return to the History Screen. Pressing *2* will cause the display to return to the History Screen without erasing the History file.

3.7.3 Program Check

```

PROGRAMMING
1=POINT PROGRAM
2=HISTORY
3=PROGRAM CHECK
  
```

Maintenance Screen #1

Pressing *3* while viewing Maintenance Screen #1 will cause the following screen to be displayed:

```

PROGRAM CHECK
1=NACS NO INPUT
2=ZONES NO INPUT
3=ZONES NO OUTPUT
  
```

Program Check Screen #1

The Program Check feature allows the programmer to view the zones which have been programmed to the Notification Appliance Circuits on the control panel but have not been programmed to Initiating Devices as well as other circuits with no input or output correlations. Pressing *1* while viewing Program Check screen will cause a screen similar to the following to be displayed.

```

NACS NO INPUT
NAC 1
005 010 012 015 017
  
```

The example above indicates that NAC 1 has been programmed to Zones 005, 010, 012, 015, and 017 but no input devices have been programmed to any of these zones. Use the up and down arrow keys to view all the NAC zones without input assignments for both NAC 1 and NAC 2.

Pressing *2* while viewing the Program Check screen will display a screen similar to the following:

```

ZONES NO INPUT
005 007 009 010 011
1M001
  
```

The Zone No Input screen allows the programmer to view the zones which have not been programmed to at least one input device (not including general alarm Zone 000). The example in the preceding screen indicates that Zones 005, 007, 009, 010 and 011 have been programmed to an addressable module (control module in this example) with an address of 001 on loop 1 but have not been programmed to any input devices. Use the up and down arrow keys to view all the zones without input assignments.

Pressing *3* while viewing Program Check screen will cause a screen similar to the following to be displayed:

```

ZONES NO OUTPUT
005 007 009 010 011
1D001
  
```

The Zone No Output feature allows the programmer to view the zones which have not been programmed to at least one output device (not including general alarm Zone 000). The example in the preceding screen indicates that Zones 005, 007, 009, 010 and 011 have been programmed to an addressable detector with an address of 001 on loop 1 but have not been programmed to any output devices. Use the up and down arrow keys to view all the zones without output assignments.

3.7.4 Walktest



To perform a walktest, press *1* while viewing Maintenance Screen #2. The following screen will be displayed:

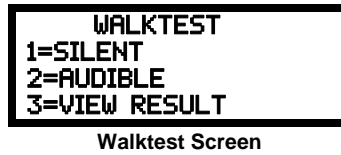

The operator can press *1* to perform a silent walktest or *2* to perform an audible walktest. Pressing *1* or *2* will cause the control panel to enter Walktest Mode and will display the following screen:



From this screen, it is possible to view the walktest log, untested system points or a summary of the addressable devices tested during the current walktest. The user can select between any of these screens without interrupting the current walktest session. The walktest session will not end until the Unit In Walktest screen is exited by pressing the Escape key to return to the Walktest Screen.

Pressing *1* for *View Walktest Log* while viewing the Unit In Walktest screen will cause a screen similar to one of the following two screens to be displayed:



OR



If there are no events in the current walktest session, the first screen will be displayed, indicating no events have been stored in the walktest log. If any events have been stored, a screen similar to the second will be displayed indicating the latest event. As walktest events occur, the display will change to indicate the latest event. All stored events can be scrolled on the screen by pressing the up or down arrow keys. To return to the first event, press the *1st Event* key.

Pressing *2* for *View Points* while viewing the Unit In Walktest screen will display one of the following screens:

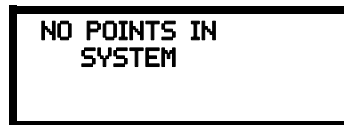

OR



If the system has no points installed, the first screen will be displayed. If points are installed, the second screen will be displayed, which allows the viewing of all untested system points and their status relating to the current walktest session. The up and down arrow keys will allow viewing of all untested points. If a point is tested while it is being displayed, the screen will update and display the next untested point. The first line indicates the total number of untested points. The second line displays information about an untested point. A description on the bottom of the screen will indicate if the displayed point has been disabled, if the Walktest option has been disabled for that point or if the point is not yet tested. The up and down arrow keys allow the user to scroll through all untested points.

Pressing *3* for *View Summary* while viewing the Unit In Walktest screen will display a new screen which will show a total of the tested detectors, tested modules, untested detectors and untested modules for the current walktest session.

To end the Walktest session, press the Escape key to return to the Walktest screen. Pressing *3* for *View Results* while viewing the Walktest screen, after a walktest session has been completed, will allow the operator to view the final results of the most recent walktest.

3.7.5 System



Pressing *2* while viewing Maintenance Screen #2, will display the following screen:

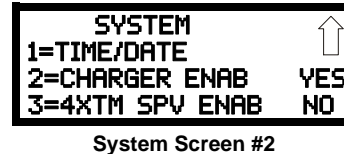
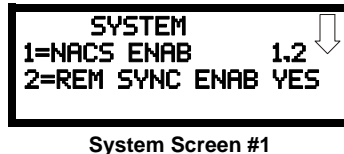

```

SYSTEM
1=NACS ENAB      1.2
2=REM SYNC ENAB YES
    
```

System Screen #1

Pressing 2 while viewing System Screen #1 will display the following:

```

ENABLE NACS
1=NAC1  N
2=NAC2  N
    
```

Enable NAC Screen

Pressing 1 while viewing NAC Screen #1 will cause the display to change to *NAC1 Yes*. This will allow the selected main circuit board NAC to activate its devices. Each press of the 1 key will cause the display to toggle between *NAC1 Yes* and *NAC1 No*. The same action is performed for the other NAC circuit by selecting the number of the desired output circuit.

```

SYSTEM
1=NAC ENAB      1.2
2=REM SYNC ENAB YES
    
```

System Screen #1

To enable remote synchronization, press the 2 key while viewing System Screen #2. Each press of the key will toggle the screen between *Rem Sync Enab Yes* and *Rem Sync Enab No*.

Pressing 1 while viewing System Screen #2 will cause the following screen to be displayed:

```

TIME AND DATE
1=TIME  01:00 AM
2=DATE  05-04-2017
3=CLOCK FORMAT 12HR
    
```

Time and Date Screen

To change the time, press 1 to display the following screen:

```

ENTER TIME
01:00 AM
1=AM           2=PM
    
```

Time Screen

A flashing cursor will appear on the left side of the display. Enter the four digit number corresponding to the time (0000 - 1259). When the fourth digit is entered, the cursor will move one position to the right. Press 1 for AM or 2 for PM to complete entering the time. The display will return to the Time and Date Screen displaying the new time.

To change the date, press 2 while viewing the Time and Date Screen. The following screen will be displayed:

```

ENTER DATE
MONTH DAY YEAR
05-04-17
    
```

Date Screen

A flashing cursor will appear on the left side of the display. Enter the two digit month, two digit day and two digit year. The cursor will move one position to the right after each entry. When the fourth digit of the year has been entered, the display will return to the Time and Date Screen which will show the new date.

The clock can be configured to display 12 hour (AM & PM) or 24 hour (military) time. Pressing 3 while viewing the Time-Date screen will cause the display to toggle between 12HR and 24HR. Select 12HR for 12 hour display or 24HR for 24 hour display.

```

SYSTEM
1=TIME/DATE
2=CHARGER ENAB NO
3=4XTM SPV ENAB NO
    
```

System Screen #2

To enable the onboard battery charger, press the 2 key while viewing System Screen #2. Each press of the key will toggle the screen between *Charger Enab Yes* and *Charger Enab No*. The setting must say *Charger Enab No* when an external battery charger is being used.

If a 4XTM Transmitter Module is installed in the system, supervision must be enabled in user programming. Pressing 3 while viewing System Screen #2 will cause the display to toggle to *4XTM Spv Enb. Yes*, which means there is a 4XTM installed. Each press of the 1 key will cause the display to toggle between *4XTM Spv Enab. No* and *4XTM Spv Enab. Yes*.

3.7.6 Zone Setup

```

PROGRAMMING
1=WALKTEST
2=SYSTEM
3=ZONE SETUP
    
```

Maintenance Screen #2

Pressing 3 while viewing Maintenance Screen #2 will display the following screen:

```

ZONE SETUP
1=ENABLE
2=DISABLE
3=SPECIAL PURPOSE
    
```

Zone Setup Screen

Pressing *1* while viewing Zone Setup screen will display the following screen:



Enable Screen

A flashing cursor appears to the right of the Z. To enable a zone, enter the three digit zone number (000 - 049). After the second digit is entered, the zone will be enabled and the cursor will return to the original position. The next zone to be enabled can then be entered. Press *Esc* (Escape) to return to the previous screen.

Pressing *2* while viewing Zone Setup screen will display the following screen:



Disable Screen

A flashing cursor appears to the right of the Z. To disable a zone, enter the three digit zone number (000 - 049). After the second digit is entered, the zone will be disabled and the cursor will return to the original position. The next zone to be disabled can then be entered. Press *Esc* (Escape) to return to the previous screen.

Pressing *3* while viewing Zone Setup screen will display the following screens:

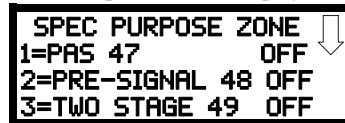

Special Purpose Screen #1



Special Purpose Screen #1

Zones 047, 048, 049, and 046 can be programmed for normal zone operation or for special purpose applications. In the above illustration, the four zones are shown Off, which means they can be programmed to function in the same manner as all other zones, by assigning them to input and output devices in the Programming Zone Assignment Screen.

Pressing *1* will cause the display to change to *PAS 47 On*. Each press of the *1* key will cause the display to toggle between *PAS 47 On* and *PAS 47 Off*. When Zone 047 is programmed On, a PAS (Positive Alarm Sequence) activation of any smoke detector will cause Zone 047 to activate. By assigning Zone 047 to a control module in the Programming Zone Assignment Screen, an output device connected to the control module can be used to indicate a PAS condition in the control panel. *Do not assign Zone 047 to a Notification Appliance Circuit when using this zone to indicate a PAS condition.*

Pressing *2* will cause the display to change to *Pre-signal 48 On*. Each press of the *2* key will cause the display to toggle between *Pre-signal 48 On* and *Pre-signal 48 Off*. When Zone 048 is programmed On, a Pre-signal activation of any device will cause Zone 018 to activate. By assigning Zone 048 to a control module in the Programming Zone Assignment Screen, an output device connected to the control module can be used to indicate a Pre-signal condition in the control panel. *Do not assign Zone 048 to a Notification Appliance Circuit when using this zone to indicate a Pre-signal condition.*

Pressing *3* will cause the display to change to *Two Stage 49 On*. Each press of the *3* key will cause the display to toggle between *Two Stage 49 On* and *Two Stage 49 Off*. Refer to "**Two Stage Operation**" on page 74 for a description of this feature.

Pressing *1* while viewing the Special Purpose Zone Screen #2 will cause the display to change to *Local Alm 46 On*. Each press of the *1* key will cause the display to toggle between *Local Alm 46 On* and *Local Alm 46 Off*. When Zone 046 is programmed On, a Local Alarm activation of any smoke detector will cause Zone 046 to activate. By assigning Zone 046 to a control module in the Programming Zone Assignment Screen, an output device connected to the control module can be used to indicate a local alarm condition in the control panel. *Local Alarm Zone alarms are not reported to the Central Station.*

Section 4: Operating Instructions

4.1 Panel Control Buttons

4.1.1 Acknowledge

The first press of the *Acknowledge* key silences the piezo sounder, changes flashing LEDs to steady, and also changes the status field on the LCD display from capital letters to small letters. When the piezo is silenced, an *acknowledge* message is sent to the printer and the history file. *Acknowledge* also sends a *silence piezo* command to the optional annunciators connected to the FACP.

When more than one event exists, the first press of the Acknowledge key functions as described in the preceding paragraph. Subsequent pressing of the key *steps* through each off-normal active event, with alarm events having a higher priority than trouble and supervisory events.

4.1.2 Alarm Silence

The *Alarm Silence* key performs the same functions as Acknowledge/Step. In addition, if an alarm exists, it turns off all silenceable NACs (Notification Appliance Circuits) and causes the Alarm Silenced LED to turn on. It also sends an ‘alarm silenced’ message to the printer, history file and optional annunciators. A subsequent new alarm will resound the system NACs. *Note that the Alarm Silenced LED is turned off by pressing the Reset key, the Drill key or subsequent activation of the NACs.*

4.1.3 Drill/Hold 2 Sec

When the *Drill* key is held for a minimum of two seconds (time required to prevent accidental activations), the FACP turns on both main panel NAC outputs and all silenceable circuits such as control modules that are programmed as silenceable, and turns off the Alarm Silenced LED if it was previously on. The *EVAC IN SYSTEM* message is shown on the LCD display. The same message is sent to the printer and history file. The *Alarm Silence* key can be used to turn off both silenceable NAC outputs following activation by the *Drill* key.

4.1.4 Reset

Pressing and releasing the *Reset* key turns off all control modules and NACs, temporarily turns off resettable power to 4-wire detectors, causes a *RESET IN SYSTEM* message to be displayed on the LCD and sends the same message to the printer and history file. It also performs a lamp test by turning on all LEDs (except the Ground LED), piezo sounder and LCD display segments after the *Reset* key is released. Any alarm or trouble that exists after a reset will resound the system.

4.1.5 Function Keys F1-F4

The four function keys are user programmable. These keys can be programmed to allow rapid disable/enable of various fire panel inputs and outputs during scheduled maintenance. Refer to “Function Keys” on page 69 for instructions on programming. Slide-in labels are provided on page 153.

4.2 LED Indicators

The 11 LED indicators, which are located on the front panel, operate as follows:

Fire Alarm

This red LED flashes when one or more alarms occur. It illuminates steady when the *Acknowledge/Step* or *Alarm Silence* key is pressed. The Fire Alarm LED turns off when the *Reset* key is pressed. The LED will remain off if all alarms have been cleared.

CO Alarm

This red LED flashes when one or more alarms occur. It illuminates steady when the *Acknowledge/Step* or *Alarm Silence* key is pressed. The CO Alarm LED turns off when the *Reset* key is pressed. The LED will remain off if all alarms have been cleared.

AC Power

This is a green LED which illuminates if AC power is applied to the FACP. A loss of AC power will turn off this LED

Supervisory

This is a yellow LED that flashes when one or more supervisory conditions occur, such as a sprinkler valve tamper condition. It illuminates steady when the *Acknowledge/Step* or *Alarm Silence* key is pressed. It turns off when the *Reset* key is pressed and remains off if all supervisory alarms have been cleared.

Trouble

This is a yellow LED that flashes when one or more trouble conditions occur. It stays on steady when the *Acknowledge/Step* or *Alarm Silence* key is pressed. The LED turns off when all trouble conditions are cleared. This LED will also illuminate if the microprocessor watchdog circuit is activated.

Ground

This is a yellow LED that flashes to indicate a ground fault condition (zero impedance from the FACP to ground).

Battery

This is a yellow LED that flashes to indicate a low battery voltage condition.

Disabled

This is a yellow LED that flashes to indicate that a zone, NAC, detector or module has been temporarily disabled in programming by the user.

Maintenance

This is a yellow LED that flashes to indicate that a smoke detector requires cleaning or replacement due to an invalid chamber reading or excessive drift.

Communication

This is a yellow LED that flashes to indicate a communication fault, including loss of phone lines, communication failure with either Central Station, or total communication failure.

Alarm Silenced

This is a yellow LED that turns on after the *Alarm Silence* key is pressed while an alarm condition exists. It turns off when the *Drill* or *Reset* key is pressed.

4.3 Normal Operation

With no alarms or troubles in the system, the display message is *System Normal* along with the current time and date as shown below. To set the time and date, refer to the appropriate section in this manual.

```

SYSTEM NORMAL
10:00A 072016

```

The NFW-50X performs the following functions at regular intervals while in Normal mode:

- ✓ Monitors AC input voltage and battery voltage
- ✓ Monitors and reports status of SLC loop, option cards, and control panel
- ✓ Polls all devices on the SLC loop and flashes each device LED while checking for valid replies, alarms, troubles, etc.
- ✓ Refreshes LCD display and updates time
- ✓ Scans control panel keypad for key presses
- ✓ Performs autotest for all SLC devices
- ✓ Tests memory
- ✓ Updates and reads all communications buses

4.4 Trouble Operation

With no alarms in the system, the detection of a trouble will cause the following:

- The piezo to pulse 1 second On and 1 second Off
- The system Trouble LED to flash one second On and one second Off
- The trouble relay to activate
- *TROUBL* with device type, noun/adjective, address and trouble description will appear on the LCD display
- The same message, along with the time and date, is sent to the optional printer and the history buffer.
- Communicate the trouble conditions to the Central Station
- Terminate upload or download communications

Note that specific troubles will initiate additional actions; for example, loss of AC power will turn off the AC Power LED, a ground fault will turn on the Ground LED, etc.

Addressable Smoke Detectors, Monitor Modules and Control Modules

For addressable devices connected to the SLC loop, the following is a typical message that could appear on the LCD display for a device trouble:

```

TROUBL SMOKE <PHOTO>
<ADJ> <NOUN>
INVREP
10:00A 010816 1D001

```

The information displayed in the above example provides the following information:

- First line in display:
 - ✓ The type of event; in this example *TROUBL* indicating a device trouble
 - ✓ Device type identifier; in this example, *SMOKE (PHOTO)* indicates a Photoelectric smoke detector. Other device type identifiers which can be displayed include *SMOKE (ION)* for Ionization Detector, *HEAT* for Heat Detector, *CONTROL* for Control Module and *MONITOR* for Monitor Module, *PULL STATION* for a manual pull box, etc. Refer to “*Edit Detector*” on page 51, “*Edit Module Screen for Monitor Module*” on page 57 and “*Edit Module Screen for Control Modules*” on page 62 for information on additional device types.
- Second line in display:
 - ✓ <ADJ>; refers to the user programmed adjective descriptor from library list resident in the control panel or custom entry via PC.

- ✓ <NOUN>; refers to the user programmed noun descriptor from library list resident in the control panel or custom entry via PC.
- Third line in display: *INVREP* indicates an invalid reply from the addressable device. Other possible troubles include:
 - *SHORT* - indicating a shorted circuit on an addressable device
 - *OPEN* - indicating an open circuit on an addressable device
 - *DIRTY1* - maintenance alert indicating that a detector is near but below the allowed alarm limit and is in need of maintenance before the performance is compromised
 - *DIRTY2* - maintenance alert indicating that a detector needs immediate maintenance since it has been within 80% of its alarm threshold for 24 hours
 - *INVREP* - maintenance alert indicating a hardware or communication problem in the detector
 - *TEST F* - indicating a detector has failed the automatic test operation which functionally checks its sensing chamber and electronics
 - *INVID* - indicating that an incorrect device code (Type ID) has been programmed for an installed device (for example, Photo has been programmed but an Ion detector has been installed)
 - *SWTBL* - indicating a module has failed the testing of its Class A switching relay
 - *BLOCK* - indicating that a beam detector's beam is totally blocked
 - *ALIGN* - indicating that a beam detector is in beam alignment mode
- Fourth line in display:
 - ✓ Time; the current time in this example is *10:00A* which represents 10:00 AM
 - ✓ Date; the current month, day and year in this example is *01* for January, *08* for the 8th day of the month and *16* for the year 2016
 - ✓ Device Address; *1D001* in this example *1* represents SLC Loop, *D* represents a detector and *001* represents device address 001

Pressing the *Acknowledge* or *Alarm Silence* key will cause the pulsing piezo to silence and the system Trouble LED to change from flashing to on steady. This block acknowledgment occurs regardless of the number of troubles, alarms and supervisory events active in the system. When the *Acknowledge* key is pressed and at least one new alarm or trouble exists in the system, the 'acknowledge' message is sent to the printer and history file. If the trouble clears, either before or after the *Acknowledge* key is pressed, the 'clear trouble' message is sent to the printer and history file.

If all troubles clear and there are no supervisory or fire conditions active in the system, the system returns to normal mode operation and the *System Normal* message is shown on the LCD display and sent to the history and printer files. The auto-restore feature will restore cleared troubles even if the troubles were never acknowledged. Note that pressing the *Alarm Silence* key when only troubles exist in the system will have the same effect as pressing the *Acknowledge* key except the Alarm Silenced LED will light.

4.5 Alarm Operation

Alarm operation is similar to trouble operation with the following differences:

- The piezo sounder produces a steady output as opposed to a pulsed output
- The Fire Alarm LED flashes 1 second On and 1 second Off
- The LCD displays *Alarm* along with the device name, type, address, adjective/noun, associated zones and time/date
- Communicate the alarm to the Central Station
- Alarms latch and *are not allowed to clear automatically*
- Alarms activate software zones if so programmed
- Timers for Silence Inhibit, Autosilence, and Trouble Reminder are started
- Alarms activate the general alarm relay and general alarm zone Z000
- The trouble relay is not activated
- Store event in history buffer
- Terminate upload or download communications
- Alarms must be Acknowledged before the FACP can be reset

A typical alarm display would be as illustrated below:

```

ALARM PULL STATION
  <ADJ> <NOUN>
          Z000
10:00A 010816 1M001
  
```

Note that the device type, which in this example is *PULL STATION*, can be any other programmable alarm type.

The information displayed in the above example provides the following information:

- First line in display:
 - ✓ The type of event; in this example *ALARM* indicating an alarm condition
 - ✓ Device type identifier; in this example, *PULL STATION* indicates a manual pull box. Other device type identifiers which can be displayed include *SMOKE (ION)* for Ionization Detector, *HEAT* for Heat Detector, *CONTROL* for Control Module and *MONITOR* for Monitor Module, *PULL STATION* for a manual pull box, etc. Refer to "*Edit Detector*" on page 51, "*Edit Module Screen for Monitor Module*" on page 57 and "*Edit Module Screen for Control Modules*" on page 62 for information on additional device types.
- Second line in display:
 - ✓ <ADJ>; refers to the user programmed adjective descriptor from library list resident in the control panel or custom entry via PC.
 - ✓ <NOUN>; refers to the user programmed noun descriptor from library list resident in the control panel or custom entry via PC.

- Third line in display: *Z000* indicates the zone programmed to this device which, in this example, is general alarm Zone 000. Note that a single device can be programmed to five different zones but only the first zone will be displayed.
- Fourth line in display:
 - ✓ Time; the current time in this example is *10:00A* which represents 10:00 AM
 - ✓ Date; the current month, day and year in this example is *01* for January, *08* for the 8th day of the month and *16* for the year 2016
 - ✓ Device Address; *1M001* in this example *1* represents SLC Loop, *M* represents a module and *001* represents device address 001

4.6 CO Alarm Operation



NOTE: When using carbon monoxide detection the system must be monitored by a Supervising Station, meeting the Standard for the Installation of Carbon Monoxide (CO) Detection and Warning Equipment, NFPA 72.

When a CO alarm operation occurs:

- The piezo sounder produces a steady Temporal 4 output
- The CO Alarm LED flashes 1 second On and 1 second Off
- The LCD displays *CO Alarm* along with the device name, type, address, adjective/noun, associated zones and time/date
- Communicate the CO alarm to the Central Station
- CO alarms latch and *are not allowed to clear automatically*
- CO alarms activate software zones if so programmed
- Timers for Silence Inhibit, Autosilence, and Alarm Reminder are started
- CO alarms activate the relays programmed for CO alarm
- The trouble relay is not activated
- Store event in history buffer
- Terminate upload or download communications
- CO alarms must be Acknowledged before the FACP can be reset

A typical CO alarm display would be as illustrated below:

```

ALARM CAR MONOXIDE
<ADJ> <NOUN>
      Z002
10:00A 090816 1M001
  
```

The information displayed in the above example provides the following information:

- First line in display:
 - ✓ The type of event; in this example *ALARM* indicating a CO alarm condition
 - ✓ Device type identifier; in this example, *CAR MONOXIDE* indicates a CO detector.
- Second line in display:
 - ✓ <ADJ>; refers to the user programmed adjective descriptor from library list resident in the control panel or custom entry via PC.
 - ✓ <NOUN>; refers to the user programmed noun descriptor from library list resident in the control panel or custom entry via PC.
- Third line in display: *Z002* indicates the zone programmed to this device which, in this example, is general alarm Zone 002. Note that a single device can be programmed to five different zones but only the first zone will be displayed.
- Fourth line in display:
 - ✓ Time; the current time in this example is *10:00A* which represents 10:00 AM
 - ✓ Date; the current month, day and year in this example is *09* for September, *08* for the 8th day of the month and *16* for the year 2016
 - ✓ Device Address; *1M001* in this example *1* represents SLC Loop, *M* represents a module and *001* represents device address 001

4.7 Supervisory Operation

Supervisory operation is similar to alarm operation but with the following differences:

- The piezo sounder pulses ½ second On and ½ second Off
- The Supervisory LED flashes ½ second On and ½ second Off
- The LCD displays the status label *Active Supervisory* along with the device name, type, address, adjective/noun, associated zones, and time/date
- Communicate the supervisory condition to the Central Station
- The supervisory relay is activated
- The alarm relay is not activated
- Silenced alarms are resounded
- Timers are not started
- Store event in history buffer
- Terminate upload or download communications

A typical Supervisory event would be displayed as illustrated in the following:

```

ACTIVE SUPERVISORY
<ADJ> <NOUN>
          Z000
10:00A 012116 1M001
  
```

Note that, like alarms, supervisory signals latch (except when programmed for supervisory autoresettable) and can be assigned to software zones. Supervisory alarms do not cause resound as do other alarm conditions. Open circuits in supervisory wiring are processed by the control panel the same way as other trouble conditions. Refer to “Alarm Operation” on page 104, for a description of the information displayed on the control panel LCD.

4.8 Process Monitor Operation

Process Monitor operation will initiate the following events:

- The piezo sounder pulses ¼ second On and ¼ second Off
- The LCD displays a process monitor message along with the device name, type, address, adjective/noun, associated zones, and time/date
- Communicate the process monitor condition to the Central Station (if the default event code has been changed from 000 to a reportable event code)
- Relays programmed for process monitoring will be activated
- The alarm relay is not activated
- Fire Alarm NACs will not activate
- SLC NACs (control modules) will activate
- Timers are not started
- Store event in history buffer
- Activate appropriate LED on the N-ANN-LED annunciator (required for this application)
- Each N-ANN-LED can support up to 10 zones.

Note that, like supervisory, process monitor signals latch (except when programmed for process monitor autoresettable) and can be assigned to software zones.

4.9 Hazard/Tornado Condition Operation

Hazard/Tornado operation is intended for Manual activation.

Hazard/Tornado Condition operation will initiate the following events:

- The piezo sounder pulses 1/4 second On, 1/4 second Off
- The LCD displays a hazard message along with the device name, type, address, adjective/noun, associated zones, and time/date
- Communicate the hazard condition to the Central Station (if the default event code has been changed from 000 to a reportable event code)
- Relays programmed for hazard will be activated
- The alarm relay is not activated
- Fire Alarm NACs will not activate
- SLC NACs (control modules) will activate
- Timers are not started
- Store event in history buffer
- Activate appropriate LED on the N-ANN-LED annunciator (required for this application)
- Each N-ANN-LED can support up to 10 zones.

Hazard conditions latch. They can be assigned to software zones.

4.10 Medical Alert Condition Operation

Medical alert operation is:

- not intended for nurse call stations (applications) per UL1069.
- not intended for signaling professional medical staff.
- to be used for summoning security guards or other trained personnel within the facility
- intended for Manual activation.

Medical Alert Condition operation will initiate the following events:

- The piezo sounder 1/4 second On, 1/4 second Off
- The LCD displays a medical alert message along with the device name, type, address, adjective/noun, associated zones, and time/date
- Communicate the medical alert condition to the Central Station
- Relays programmed for medical alert will be activated
- The alarm relay is not activated
- Fire Alarm NACs will not activate
- SLC NACs (control modules) will activate

- Timers are not started
- Store event in history buffer
- Activate appropriate LED on the N-ANN-LED annunciator (required for this application)
- Each N-ANN-LED can support up to 10 zones.

Medical alert conditions latch. They can be assigned to software zones.

4.11 NAC Operation

There are two programmable NACs (Notification Appliance Circuits) resident on the NFW-50X main circuit board. Both NACs may be programmed as silenceable or nonsilenceable and may also be programmed for steady or coded operation. Coded operation provides a choice between March Time, Temporal or California coding.

4.12 Programmed Zone Operation

Each addressable detector and monitor module can be assigned to a maximum of five software alarm zones. A general alarm zone Z000 may be listed for output (control) points, but it is not necessary to list Z000 for input points, since this is the default zone for all alarm input devices. Zone Z000 is not activated by supervisory points.

When an input device alarms and is not disabled, it activates all software zones assigned to it. An output device that is not disabled is turned on when any of the software zones to which it is programmed become active. Only alarms, hazards/tornado alerts can turn on either of the two main NACs.

4.13 Disable/Enable Operation

Input points which are disabled do not cause an alarm or any zone activation. Disabled output points are held in the off state. All disabled points are treated as if they were in trouble, with the exception being the status label that will be displayed is *DISABL*.

4.14 Waterflow Circuits Operation

If an alarm exists from a monitor module point that has a waterflow type code and its mapped NAC control module outputs are programmed for nonsilenceable operation, the Alarm Silence key will not function. Also, any output zone activated by a waterflow device will not be silenceable if the Waterflow Silenceable option is set to NO in system programming.

4.15 Detector Functions

Maintenance Alert

Each addressable detector is monitored by the control panel for its maintenance status. If a detector is near but below the allowed alarm limit, a 'maintenance alert' message will automatically be displayed, signaling that the detector is in need of servicing.

Automatic Test Operation

An automatic test of an addressable detector is performed each minute, resulting in a complete SLC loop test in approximately 5 hours (if the loop has the maximum number of devices installed). The detector's sensing chamber and electronics are functionally tested for normal, safe operation. A trouble message is displayed upon failure of this test. A System Reset will clear this trouble.

Type Code Supervision

The FACP monitors addressable hardware device codes at slow intervals. Mismatch of any type code, compared to the system program, will cause a device trouble.

System Alarm Verification

The control panel may be programmed to perform alarm verification to help eliminate the nuisance of false alarms. Alarm verification applies to smoke detectors only.

Smoke Detector Data

Smoke detector data is monitored by the FACP, eliminating the need to test the sensitivity of each detector at its location. A printout of each detector's data can be retrieved from the FACP using an optional printer or Windows® HyperTerminal. Detector sensing ability can decrease with age and should be monitored as part of a system's routine maintenance.

4.16 Time Functions: Real-Time Clock

The NFW-50X includes a crystal-based clock that provides time of day, date and day of week. Time is displayed as 12 or 24 hour time with month/day/year and is stored in RAM. Daylight savings time change-over is programmable and automatic. If both AC and battery are lost, the time must be reset.

4.17 Synchronized NAC Operation

Synchronization is a panel feature that controls the activation of notification appliances in such a way that all devices will turn on and off at exactly the same time. This is particularly critical when activating strobes which must be synchronized to avoid random activation and a potential hazard or confusion. The FACP can be programmed to operate with a variety of manufacturer's devices. NAC synchronization can only be supported properly by the Remote Power Supply Sync Terminal, which follows NAC 1 programming.

Important: When a Notification Appliance Circuit with a mix of audible and visual devices is programmed for silenceable and the synchronization feature is selected, only the audible devices will be turned off if the Silence key is pressed. The visual devices (strobes, etc.) will continue to operate.

4.18 Coded Operation

The NAC circuits resident on the control panel main circuit board can be programmed for coded operation. The available pulse rates which can be programmed for coded operation are as follows:

- Continuous: Steady output with no pulsing
- March Time: Pulses at 120 ppm (pulses per minute)
- Temporal 3 Code: Pulses at 1/2 second On, 1/2 second Off, 1/2 second On, 1/2 second Off, 1/2 second On, 1-1/2 second Off
- Temporal 4 Code: Pulses at 1/2 second On, 1/2 second Off, 1/2 second On, 1/2 second Off, 1/2 second On, 1/2 second On, 1/2 second Off, 1-1/2 second Off
- California Code: 10 seconds On, 5 seconds Off
- Two-Stage: Pulses at 20 ppm (pulses per minute) for 3 or 5 minutes (depending on programming) and then changes to Temporal

4.19 Presignal

Presignal option programs an initiating device to delay the activation of NACs and/or control modules while allowing visual verification by a person. Once a detector or monitor module triggers an alarm, the onboard piezo sounds immediately, but the NACs are not activated for a user programmed time duration of up to three minutes. Note that the alarm relay and communicator will respond to the initial alarm immediately. In addition, Zone 048 will activate. This zone can be programmed to a control module which may be used to activate a sounder or indicator which the installer designates as a Presignal indication. *Do not assign Zone 048 to a Notification Appliance Circuit when using this zone to indicate a Pre-signal condition.*

After the programmed delay, the NACs will activate if the source of the alarm is not cleared. Note that if a second alarm occurs during the programmed time delay, the alarm will be processed immediately, causing activation of the appropriate output zones. The events which occur upon Presignal activation are as follows:

- ✓ onboard piezo sounds immediately
- ✓ control panel LCD display will indicate a presignal event and the active point
- ✓ control points programmed to Zone 048 will activate
- ✓ annunciators (if enabled) will sound the local piezo, and pulse the alarm LED and zone LED
- ✓ outputs (NACs and control modules) of associated zones will be inhibited from activating for a user programmed time delay of up to three minutes
- ✓ second alarm occurring anytime during the time delay will cause immediate activation of all associated outputs

Presignal does not affect monitor modules programmed as waterflow, supervisory, process monitoring or remote switches. *Presignal operation requires the approval of the local Authority Having Jurisdiction.*

4.20 Positive Alarm Sequence

PAS (Positive Alarm Sequence) option will program a smoke detector to delay panel activation (including alarm relay and communicator) for a period of 15 seconds. Zone 047, however, will activate immediately and may be used to connect a signaling device to indicate PAS activation. *Do not assign Zone 047 to a Notification Appliance Circuit when using this zone to indicate a PAS condition.*

When a detector triggers an alarm, the onboard piezo sounds immediately, but the NACs are prevented from activating for 15 seconds. This inhibit time is factory set and cannot be changed. Pressing the Alarm Silence or Acknowledge/Step key during the 15 second inhibit time will silence the piezo sounder and start a timer which prevents activation of NACs for an additional time duration which can be user programmed for up to three minutes. After the programmed delay, the NACs will activate if the source of the alarm is not cleared. Note that if a second alarm occurs during either time delay, the alarm will be processed immediately, causing activation of the appropriate output zones. The events which occur upon PAS activation are as follows:

- ✓ onboard piezo sounds immediately
- ✓ control panel LCD display will indicate a presignal event and the active point
- ✓ control points programmed to Zone 047 will activate
- ✓ outputs (NACs and control modules) of associated zones will be inhibited from activating for a factory set duration of 15 seconds
- ✓ pressing the Alarm Silence or Acknowledge/Step key will start a timer which inhibits output activation for additional time delay of up to three minutes which is user programmable
- ✓ second alarm occurring anytime during either time delay will cause immediate activation of all associated outputs

PAS operation requires the approval of the local Authority Having Jurisdiction.

Note that the *PAS BYPASS* monitor type code, when activated, will inhibit the PAS capability until the *PAS BYPASS* monitor is deactivated. While PAS is inhibited, signaling devices will immediately place the control panel into alarm. This feature may be employed by wiring a normally open device, such as a switch, to a monitor module which has been programmed for *PAS BYPASS*.

4.21 Special System Timers

4.21.1 Silence Inhibit Timer

This option, if selected, prevents the *Alarm Silence* key from functioning for 5 minutes following an alarm. A new alarm during the initial 5 minute period will not cause the timer to restart with a new 5 minutes. *Silence Inhibit operation requires the approval of the local Authority Having Jurisdiction.*

4.21.2 Autosilence Timer

If Autosilence is selected, the notification appliances, programmed as silenceable, will automatically be silenced after a programmable duration of 5 to 30 minutes. Pressing the *Drill* key will restart the timer. *Autosilence operation requires the approval of the local Authority Having Jurisdiction.*

4.21.3 Trouble Reminder

If selected, this feature causes a reminding 'beep' every 15 seconds during an alarm (after the *Alarm Silence* key is pressed) and every two minutes during a trouble condition (after the *Acknowledge/Step* or *Alarm Silence* key is pressed). The 'beeps' from the onboard piezo sounder will occur until the alarm or fault is cleared.

Note that if the trouble is not cleared within 24 hours, the piezo will resound, indicating that the trouble condition still exists.

4.21.4 Waterflow Retard Timer

If selected, this option will delay the activation of a waterflow type alarm for a programmable time duration from 1 to 90 seconds. This delay is in addition to any time delay inherent in the waterflow device. *This feature requires the approval of the local Authority Having Jurisdiction.*

4.21.5 Alarm Verification (None or One Minute)

If alarm verification is selected, an addressable smoke detector's alarm is ignored for a retard time of 13 seconds and the detector's alarm condition is automatically reset. There will be no alarm indication at the FACP during the Retard period. A confirmation period of 60 seconds follows, during which a subsequent alarm from the same detector will cause the panel to immediately activate the appropriate outputs and indicate the alarm condition at the FACP. If a different detector alarms any time during the first detector's verification period, the panel will immediately activate all appropriate outputs and indicate the alarm condition at the FACP. If no additional detector alarms occur within 73 seconds of the first alarm (13 second retard plus 60 second confirmation), the timer resets and the panel is ready to verify any new detector alarms which may occur. The following is a graphic representation of Alarm Verification.

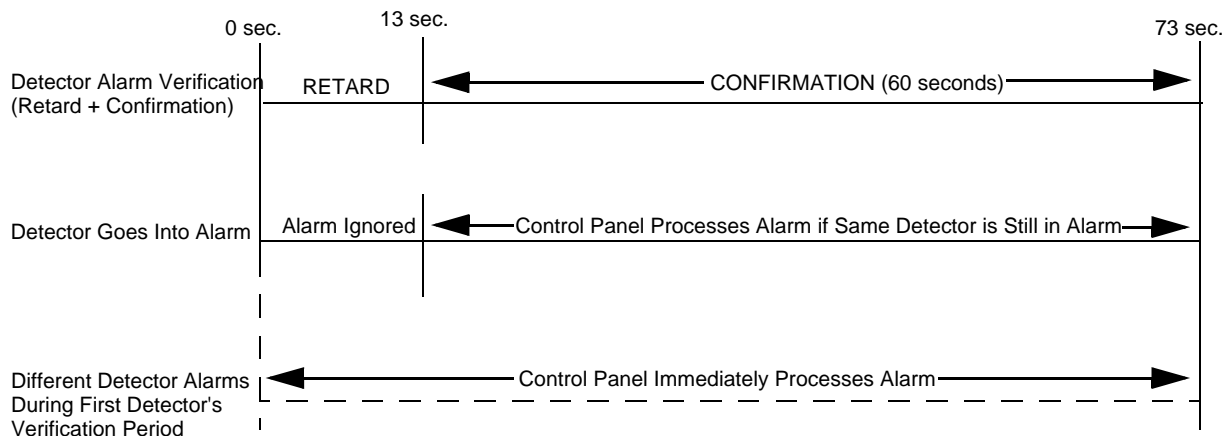

NOTE: Alarm Verification is available only for addressable smoke detectors, not conventional smoke detectors.

4.21.6 Control Module Delay Timer

The control module delay feature, if enabled, will delay activation of a control module after a programmed time of 1-180 seconds after being triggered by an alarm condition. *This feature requires the approval of the local Authority Having Jurisdiction.* Refer to the table on page 46 for permissible settings.

4.22 Walktest

Walktest is a feature which allows one person to test the fire alarm system. An audible walktest will momentarily sound the Notification Appliance Circuits in the building and store the walktest information in a file at the panel. A silent walktest will not sound the NACs but will store the walktest information in a file which can be viewed at the panel. Disabled NAC devices will not activate during walktest.

Alarm/Shorted Condition

When in audible Walktest, the panel responds to each new alarm and activates its programmed control outputs for four seconds, if those outputs have been programmed for silenceable activation. It also stores each alarm in the walktest history file which can be sent to an optional printer. The stored display will be the same as if the device actually activated except the colon (:) in the time stamp is replaced with an asterisk (*).

Note that if the system under test includes one or more enabled monitor modules, the following may apply:

If the monitor module is used for a supervised, 2-wire smoke zone, alarming any monitor module in the system will result in the activation of programmed control outputs for an additional eight seconds or less. This is caused by the temporary removal of 24 VDC resettable power from the monitor module. The monitor module reports this loss of power as an open condition in addition to the alarm condition.

Open Condition

Addressable devices are monitored for fault conditions during Walktest mode. When a new trouble condition occurs, the FACP will activate all NACs and control modules programmed for Walktest and mapped to the faulty device, then shut them off after eight seconds.

While in Walktest, the trouble relay is activated and the system Trouble LED flashes (as in all of the Program and status change operations). The alarm relay is not activated.

4.23 Read Status

Read Status functions do not require a password. The control panel will continue to provide fire protection while in Read Status mode. This mode can be entered while the control panel is in alarm or trouble. If a new alarm or trouble occurs during these functions, the Read Status is exited to prevent confusion.

Read Status Entry

When the operator presses the control panel **ENTER** key, the LCD will display the following:



Pressing *I*, while this screen is being displayed, will cause the control panel to enter the Read Status mode which allows the user to view and print the programmed features and status of the control panel.

The following screens will be displayed:

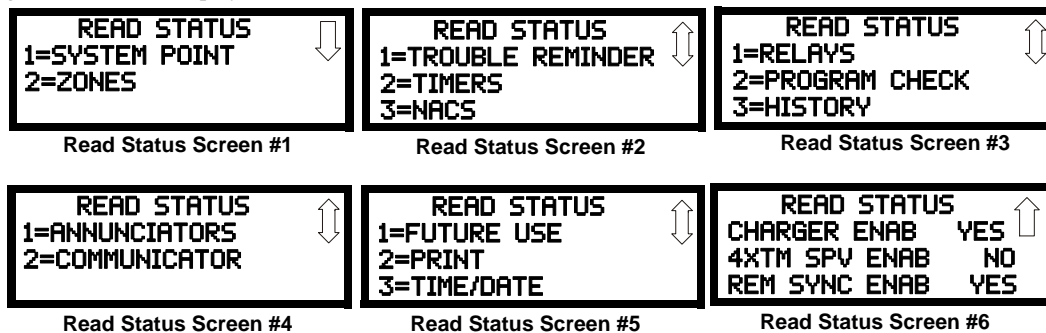

4.23.1 System Point



Read Status Screen #1

Pressing *I* while viewing Read Status Screen #1 will cause the following screen to be displayed:

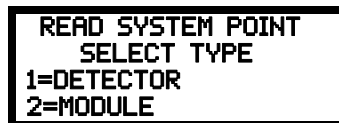

The operator selects the type of device which is to be viewed by pressing *I* for Detector or 2 for Module. If *I* is pressed, the display will change to the following screen:



Entering the three digit detector address will cause the control panel to display the current status of the selected device. For example, if a detector with address *001* on the SLC loop is entered, a display similar to the following will appear:

```

NORMAL SMOKE(PHOTO)
NORTH CLASSROOM
      Z005
V  1D001
  
```

The information in the preceding display includes:

- *NORMAL* - the present status (could also be ALARM, TROUBL, DISABL, etc.)
- *SMOKE (PHOTO)* - the device type which is a photoelectric smoke detector (could also be ION for ionization smoke detector)
- *NORTH CLASSROOM* - the Adjective/Noun label for this device
- *Z005* - the first of five possible assigned software zones
- *ID001* - *I* = SLC Loop, *D* = Detector, *001* = Address 001
- *V* - Alarm Verification Enabled (*V* = Yes, * = No)
- *S* - Silenceable for control modules (*S* = Yes, * = No)
- *W* - Walktestable for control and monitor modules (*W* = Yes, * = No)

Pressing the down arrow key, while viewing the screen shown above, will allow the operator to view additional programming information about the selected device, such as:

- Enable/Disable Status
- Device Type
- Alarm Verification On/Off (for detectors)
- Walktest Yes/No
- PAS (Positive Alarm Sequence) Yes/No (for detectors only)
- Pre-Signal Yes/No (for detectors and monitor modules)
- Zone Assignments (five maximum)
- Chamber Value
- Adjective/Noun descriptor
- Silenceable Yes/No (for control modules)
- Wireless Yes/No (for detectors only)
- Sounder Base Yes/No (for detectors only)
- Sounder Base Values and Zone Assignments (for detectors only)

4.23.2 Zones

```

READ STATUS
1=SYSTEM POINT
2=ZONES
  
```

Read Status Screen #1

Pressing 2 while viewing Read Status Screen #1 will cause the following screens to be displayed:

```

      ZONES
1=ZONES INSTALLED
2=ZONES ENABLED
3=ZONES DISABLED
  
```

Zones Screen #1

```

      ZONES
1=SPECIAL PURPOSE
2=ZONE TYPE
  
```

Zones Screen #2

From the preceding screens, the control panel operator can view:

- *Zones Installed* - all software zones programmed into the system (49 maximum)
- *Zones Enabled* - all software zones that are enabled
- *Zones Disabled* - all software zones that have been disabled
- *Special Purpose* - on or off programming for Special Purpose Zones 047 reserved for PAS, 048 reserved for Pre-signal, 049 reserved for Two Stage, and 046 for Local Alarm
- *Zone Type* - the Type assigned to each installed zone (default is Alarm)

4.23.3 Trouble Reminder

```

READ STATUS
1=TROUBLE REMINDER
2=TIMERS
3=NAC
  
```

Read Status Screen #2

Pressing 1 while viewing Read Status Screen #2 will display the following screen:

```

TROUBLE REMINDER
TROUBLE REM    24HR
  
```

The screen indicates whether the Trouble Reminder feature is set to sound every 4 or 24 hours.

4.23.4 Timers

Pressing 2 while viewing Read Status Screen #2 will cause the following Timer screens to be displayed:



These screens will indicate the delay time, in seconds, for each of the first three and last possible delay options. The AC Loss Delay time is displayed in hours.

4.23.5 NACs

Each NAC can be programmed individually with unique settings with the exception of Canadian Mode. When the Canadian Option is selected in programming (see “Canadian Option” on page 75), all NAC settings are changed to that of NAC 1. While in Canadian Mode, if any NAC is setting is changed, all NACs will get those same settings. Pressing 3 while viewing Read Status Screen #2 will display the following screen:

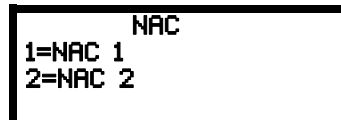

The operator can press 1 to view the programmed options for NAC 1, or 2 to view the programmed options for NAC 2. The resulting screens will display the following information:

- Enable/Disable Status
- Circuit Type (Bell, Strobe, etc.)
- Silenceable/Nonsilenceable
- Auto Silence Enable/Disable and time delay (in minutes)
- Coding Selection (Temporal, Steady, etc.)
- Zone Assignments
- Silence Inhibit Enabled/Disabled
- Synchronization Type (System Sensor, Wheelock, or Gentex)

4.23.6 Relays



Read Status Screen #3

Pressing 1 while viewing Read Status Screen #3 will display the following screen:



The operator can view the programmed option for each relay by pressing the corresponding number key.

4.23.7 Program Check

Pressing 2 while viewing Read Status Screen #3 will cause a screen similar to the following to be displayed:

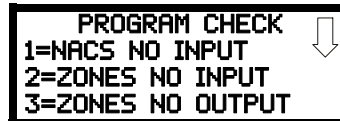

Program Check Screen #1

Pressing 1 while viewing Program Check screen #1 will display a screen which will indicate if any input zones have not been programmed to one of the Notification Appliance Circuits. Use the up and down arrow keys to view both NAC circuits.

Pressing 2 while viewing the Program Check screen #1 will display a screen which will indicate if any output zones have not been programmed to at least one input zone. Use the up and down arrow keys to view all zones.

Pressing 3 while viewing the Program Check screen #1 will display a screen which will indicate if any input zones have not been programmed to at least one output zone. Use the up and down arrow keys to view all zones.

4.23.8 History

Pressing 3 while viewing Read Status Screen #3 will display the following screen:



The operator can view all events which have been stored in the history file, only alarms or other events, such as troubles or supervisories, by pressing the corresponding number key.

4.23.9 Annunciators



Read Status Screen #4

Pressing 1 while viewing Read Status Screen #4 will display the following screens:

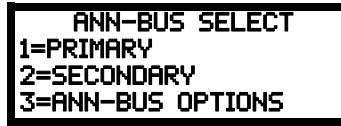

Annunciator Screen

Pressing 1 or 2 for ANN-BUS while viewing the Annunciator Screen allows the operator to view the settings and devices for each ANN-BUS. Press 1 for the Primary ANN-BUS and 2 for the Secondary ANN-BUS.

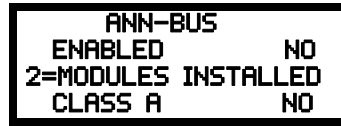

ANN-BUS Screen #1

The ANN-BUS Screen #1 indicates if the ANN-BUS has been enabled *Yes* or disabled *No*.

Pressing 2 for *Modules Installed* while viewing ANN-BUS Screen #1 will display screens for ANN-BUS Addresses 1 -8 and the devices installed at each address. A subscreen will display the options that have been programmed for each device.

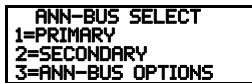

Annunciator Screen

Pressing 3 for ANN-BUS Options while viewing the Annunciator Screen allows the operator to view the settings for any ANN-S/PG, ANN-LED, ANN-80, and ANN-100 installed in the system.



ANN-BUS Screen #2

Pressing 1 for ANN-S/PG Options while viewing ANN-BUS Screen #2 will display the options selected for the installed N-ANN-S/PG annunciators.

Pressing 2 for ANN-LED Options while viewing ANN-BUS Screen #2 will display the options selected for the installed N-ANN-LED annunciators.

Pressing 3 for ANN-80/100 Options while viewing ANN-BUS Screen #2 will display the options selected for the installed N-ANN-80 or N-ANN-100 annunciators.

4.23.10 Communicator



Read Status Screen #4

Pressing 2 while viewing Read Status Screen #4 will display the following screens:



Communicator Screen #1



Communicator Screen #2



Communicator Screen #3



Communicator Screen #4

The Communicator Screen #1 indicates if an IPOTS-COM has been installed *Yes* or *No*.

Pressing 2 for *POTS Settings* while viewing Communicator Screen #1 will display settings for the telephone portion of the Communicator.

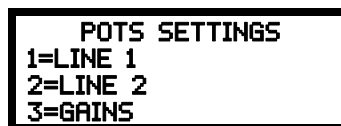

Pressing 1 or 2 will display whether each phone line is enabled *Yes* or disabled *No*, whether the phone type is *touchtone* or *rotary*, and whether the phone line is being supervised *Yes* or *No*.

Pressing 3 will display the phone lines' Gains setting. The value for the Dialing Gains and Reporting Gains is shown as *High*, *Normal*, or *Low*.

```

READ STATUS
INSTALLED      YES
2=POTS SETTINGS
3=IP SETTINGS
    
```

Communicator Screen #1

Pressing 3 for *IP Settings* while viewing Communicator Screen #1 will display settings for the ethernet portion of the Communicator. The screen will indicate if DHCP has been enabled *Yes* or disabled *No*. If the DHCP has not been enabled, the Static Settings will be displayed.

```

COMMUNICATOR
1=PRI COMM PATH
2=SEC COMM PATH
TBL REPORT LIMIT 0
    
```

Communicator Screen #2

Communicator Screen #2 allows the programmer to press 1 to view the *Primary Communication Path* settings or 2 to view the *Secondary (backup) Communication Path* settings for the Communicator and indicates the Call Limit for Communicator trouble calls within a 24 hour period.

Pressing 1 while viewing Communicator screen #2 will cause the following screen to be displayed:

```

COMMUNICATOR
1=POTS
2=ETHERNET
3=CELLULAR
    
```

Pressing 1 for *POTS* indicates whether the receiver has been enabled or disabled. It also provides information on the receiver such as:

- Account Code
- Phone Number Prefix
- Phone Number
- Communication Format

Pressing 2 for *Ethernet* indicates whether the receiver has been enabled or disabled. It also provides information on the receiver such as CS account info.

Pressing 3 for *Cellular* indicates whether the receiver has been enabled or disabled. It also provides information on the receiver such as the CS account.

```

COMMUNICATOR
1=EVENT CODES
TEST TIME INT 24
24HR TEST TIME 0100
    
```

Communicator Screen #3

Communicator Screen #3 allows the user to view the Event Codes for the chosen communication format as well as the Test Time Interval and 24 Hour Test Time.

```

COMMUNICATOR
REPORT STYLE POINT
    
```

Communicator Screen #4

Communicator Screen #4 allows the user to view whether the reporting style is by *Point* or *Zone*.

4.23.11 Print

```

READ STATUS
1=FUTURE USE
2=PRINT
3=TIME/DATE
    
```

Read Status Screen #5

To print program data or control panel status, press 2 while viewing Read Status Screen #5. The following screens will be displayed:

```

PRINT
1=HISTORY
2=WALKTEST LOG
3=WALKTEST SUMMARY
    
```

Print Screen #1

```

PRINT
1=DETECTOR DATA
2=COMM SETTINGS
3=EXIT PRINTING
    
```

Print Screen #2

Pressing 1 while viewing Print Screen #1 allows the user to print the History file which will detail all of the system activities since the file was last cleared from memory.

Pressing 2 while viewing Print Screen #1 allows the user to print the Walktest log which will detail all of the system activations during walktest since the log was last cleared.

Pressing 3 while viewing Print Screen #1 allows the user to print the Walktest summary which will list the total of each type of input activation.

Pressing 1 while viewing Print Screen #2 allows the user to print the detector data for each addressable smoke detector connected to the system. A printout, similar to the following example, will be generated if an optional printer is connected to the FACP.

DEVICE #	DEVICE TYPE	% DRIFT COMP	CHAMBER	TIME/DATE
1D001	SMOKE (PHOTO)	20	1281	12:01 AM 01-08-2016
1D002	SMOKE (PHOTO)	20	1281	12:01 AM 01-08-2016
1D003	SMOKE (PHOTO)	21	1259	12:01 AM 01-08-2016
1D004	SMOKE (PHOTO)	20	1309	12:02 AM 01-08-2016
1D005	SMOKE (PHOTO)	21	1281	12:02 AM 01-08-2016
1D006	SMOKE (PHOTO)	20	1322	12:02 AM 01-08-2016
1D007	SMOKE (PHOTO)	20	1280	12:02 AM 01-08-2016
1D008	SMOKE (PHOTO)	20	1215	12:02 AM 01-08-2016

DEVICE #	DEVICE TYPE	% DRIFT COMP	CHAMBER	TIME/DATE
ID009	SMOKE (PHOTO)	20	1310	12:02 AM 01-08-2016

Chamber Value

The Chamber value should be within the indicated range for the following smoke detectors:

- NP-100(R), NP-200(R), FSP-851(T/R), FSP-951(T/R), ND-100(R), and FSD-751(R)PL Addressable Photoelectric Smoke Detectors: **405 - 2100** (obscuration of 1.00%/ft to 3.66%/ft.)
- FSI-851 and NI-100 Addressable Ionization Smoke Detectors: **750 - 2100** (obscuration of 0.50%/ft. to 1.44%/ft.)

If the addressable smoke detector’s Chamber reading is not within the acceptable range, clean the detector and check the Chamber value again. If the reading is still not within the acceptable range, immediately replace the detector.

Drift Compensation

Drift compensation uses software algorithms that identify and compensate for long-term changes in the data readings from each addressable smoke detector. These long-term changes in detector data readings are typically caused by dirt and dust accumulation inside the smoke chamber. Drift compensation performs the following functions:

- Samples photoelectric smoke detectors every 6 seconds and ionization smoke detectors every 3 seconds
- Allows a smoke detector to retain its original ability to detect actual smoke and resist false alarms, even as dirt and dust accumulate
- Reduces maintenance requirements by allowing the control panel to automatically perform the periodic sensitivity measurements required by NFPA Standard 72

The FACP software also provides filters to remove transient noise signals, usually caused by electrical interference.

Maintenance Alert

The software determines when the drift compensation for a detector reaches an unacceptable level that can compromise detector performance. When a detector reaches an unacceptable level, the control panel indicates a maintenance alert. Table 4.1 summarizes the three levels of maintenance alert:

Maintenance Level:	FACP Status Displays:	Indicates:
Low Chamber Value	INVREP	A hardware problem in the detector
Maintenance Alert	DIRTY1	Dust accumulation that is near but below the allowed limit. <i>DIRTY 1</i> indicates the need for maintenance before the performance of the detector is compromised
Maintenance Urgent	DIRTY2	Dust accumulation above the allowed limit.

Table 4.1 Maintenance Alert Levels

Figure 4.1 illustrates a graphic representation of the maintenance levels:

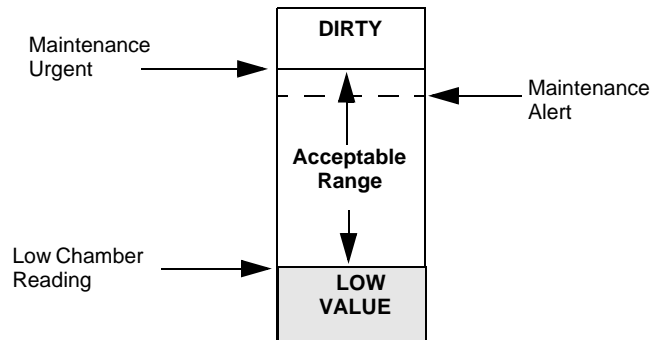

Figure 4.1 Diagram of Maintenance Levels

```

PRINT
1=DETECTOR DATA
2=COMM SETTINGS
3=EXIT PRINTING
Print Screen #2
    
```

Pressing 2 while viewing Print Screen #2 allows the user to print the Communicator’s settings. Refer to “Communicator” on page 77 for additional information on the display.

Pressing 3 while viewing Print Screen #2 exits the user from the print menu.

4.23.12 Time-Date

```

READ STATUS
1=FUTURE USE
2=PRINT
3=TIME/DATE
    
```

Read Status Screen #5

The operator can view the daylight savings time and the month and week when daylight savings time will begin and end. Pressing 2 while viewing Read Status Screen #5 will display the following screens:

```

DAYLIGHT SAVINGS
ENABLED YES
START MONTH MAR
START WEEK WEEK-2
    
```

```

DAYLIGHT SAVINGS
END MONTH NOV
END WEEK WEEK-1
    
```

4.23.13 Battery Charger

```

READ STATUS
CHARGER ENAB YES
4XTM SPV ENAB NO
REM SYNC ENAB YES
    
```

Read Status Screen #6

Read Status Screen #6 indicates whether the onboard battery charger is enabled or disabled.

4.23.14 4XTM Supervision

Read Status Screen #6 indicates whether 4XTMF Supervision is enabled or disabled.

4.23.15 Remote Sync

Read Status Screen #6 indicates whether remote synchronization is enabled or disabled.

Section 5: Central Station Communications - POTS Transmission

The control panel transmits zone and system status reports to Central Stations via the public switched telephone network. Two supervised telephone line connections are made to interface the control panel to the telephone lines. Two optional 7 foot telephone cords are available for this purpose and can be purchased separately.

The control panel supervises both telephone lines for proper voltage. A delay of two minutes will occur before a fault in either phone line connection is reported as a trouble. When a fault is detected, an audible trouble signal will sound, the yellow trouble LED will blink, the LCD display will indicate the phone line trouble and the trouble condition will be reported to the Central Station over the remaining operational phone line.

The control panel comes with line seizure capability provided for both the primary and secondary telephone line interfaces. Any time that the control panel needs to make a call to a Central Station, line seizure will disconnect any local premises phones sharing the same telephone line.

All transmissions to the Central Stations will be sent over the primary phone line. In the event of noisy phone lines, transmissions will be sent over the backup secondary phone line.

Two phone numbers must be programmed, the primary Central Station phone number and the secondary Central Station phone number. All system reports will be transmitted to the primary Central Station phone number. Reports will automatically be sent to the secondary Central Station phone number if attempts to transmit to the primary Central Station phone number are unsuccessful. If 10 total attempts to communicate are unsuccessful, a Communicator Failure report will be displayed.

The NFW-50X meets NFPA 72 National Fire Code reporting requirements for: (a) the type of signal, (b) condition and (c) location of the reporting premises. The general priority reporting structure is:

1. Zone Alarms and Restores
2. Zone Troubles and Restores
3. System Troubles and Restores
4. 24-hour Test

The minimum wire gauge allowed is 26 AWG.

5.1 Transmittal Priorities

The integral communicator transmits highest priority events first. Events, in terms of priority, are listed below in descending order:

1. Alarms (highest priority level)
 - ✓ Pull stations
 - ✓ Waterflow
 - ✓ Smoke detector
 - ✓ Other fire alarm types
 - ✓ CO alarm
2. Supervisory Zone
3. System Troubles
 - ✓ Zone disabled
 - ✓ Fire drill
 - ✓ AC fail (after delay)
 - ✓ Zonal faults
 - ✓ Earth fault
 - ✓ Low battery
 - ✓ Telephone line fault
 - ✓ Notification Appliance Circuits fault
 - ✓ Communication trouble
 - ✓ Annunciator trouble
 - ✓ System off normal
4. Restoral Reports
 - ✓ Zone alarm
 - ✓ Supervisory
 - ✓ Zone(s) enabled
 - ✓ Fire drill
 - ✓ AC
 - ✓ Zone fault
 - ✓ Earth
 - ✓ Battery
 - ✓ Telephone line
 - ✓ Notification Appliance Circuits
 - ✓ Communication
 - ✓ Annunciator trouble
 - ✓ System off normal
5. 24 Hour Test (lowest priority)

Red LEDs are provided on the circuit board to identify which telephone line is activated. Also, a green LED labeled *Kissoff* will turn on whenever the control panel has successfully transmitted reports to the Central Station. The *Kissoff* LED may turn on several times during communications with a Central Station.

The table below shows UL listed receivers which are compatible with the NFW-50X.

Format	Ademco 685 (1)	Ademco MX8000 (2)	Silent Knight 9500 (3)	Silent Knight 9800 (4)	Osborne Hoffman 2000E (5)	Radionics 6600 (6)	SurGard MLR2 (7)	SurGard System III (8)	SurGard MLR-2000 (9)	FBI CP220FB (10)	Honeywell Security AlarmNet 7810-ir
0	SIA-DCS-8	✓	✓	✓	✓	✓		✓		✓	
1	SIA-DCS-20		✓	✓	✓	✓		✓		✓	
2	Ademco Contact ID	✓	✓	✓	✓	✓	✓	✓	✓	✓	✓

Table 5.1 Compatible UL Listed Receivers

1. With 685-8 Line Card with Rev. 4.4d software
2. With 124060V206B and 124063 Line Card Rev. B
3. With version V2.4 Receiver and 126047 Line Card Rev. G
4. With 124077V2.00 Receiver and 126047 Line Card Rev. M
5. With V.7301 Receiver S/W
6. With 01.01.03 Receiver S/W and Line Card 01.01.03
7. With software V1.86
8. With software V1.72
9. With DSP4016 and V1.6 Line Card
10. With software V3.9

IMPORTANT! It is the installer’s responsibility to ensure that the Digital Alarm Communicator/Transmitter is compatible with the Central Station Receiver, utilized by the monitoring service, prior to installation. The Compatibility Table provides a list of compatible receivers and associated software versions for the receivers. Changes in the hardware and/or software by the receiver manufacturers may affect the receiver compatibility with the FACP DACT. After completing the installation, communication between the DACT and Central Station Receiver must be tested and verified.

Section 6: FS-Tools Upload/Download

Important! The FACP will automatically reset 2 minutes after completion of a user program download via the FS-Tools programming utility. To prevent program corruption, the operator must wait until this panel reset occurs before performing any panel operations.

The control panel may be programmed or interrogated off-site via an Ethernet connection or locally using a USB cable. Any personal computer with Windows® XP or newer, 32 or 64 bit, and Upload/Download software FS-Tools, may serve as a Service Terminal. This allows download of the entire program or upload of the entire program, history file, walktest data, current status, system voltages, time and date.

The control panel may also communicate to a local PC at the job-site. The PC must be connected to the USB connector J20 on the FACP main circuit board. A standard USB cable with male-A to male-A connectors, which must be purchased separately, is required.

Important: Remote modification of FACP programming requires that the panel be enabled for remote download (refer to 6.1, "FS-Tools Up/Download" below). Remote interrogation of panel programming, history logs, detector status, etc., is possible without enabling the remote download option.

CAUTION: After successfully downloading a program, make certain to perform the following steps:

1. Print out all programmed data via Print Mode or manually view programmed entries and compare to intended program data
2. Test all affected panel operations
3. Immediately correct any problems found

6.1 FS-Tools Up/Download

NFPA 72 requirements state that a technician be on-site and at the control panel whenever the FS-Tools Programming Utility is used to download any information to the FACP. This applies to local and remote programming. For this reason, a new option has been added to the FACP which allows an individual at the FACP to enter a password and either enable the proprietary mode where downloading will be allowed at any time or access a specific password protected screen where downloading will be allowed regardless of the current proprietary setting. The FS-Tools Download option can be selected from the main menu screen as shown below:

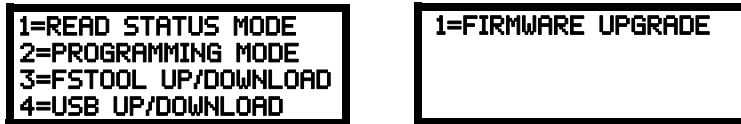

Pressing 3 for FS-Tools Download while viewing the main menu will cause the following screen to be displayed:



The FS-Tools Download password (default 22222222) must be entered to access the FS-Tools Download feature. Note that the default password can be changed using the Password Change option (refer to "Password Change" on page 95). Entering the correct password will cause the following screen to be displayed:

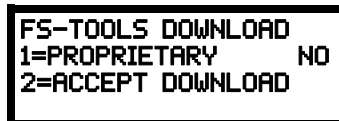

Pressing 1 for *Proprietary No* (factory default setting), while viewing the FS-Tools Download screen, will cause the display to toggle from *Proprietary No* to *Proprietary Yes*. Each press of the 1 key will cause the display to toggle between *Proprietary No* and *Proprietary Yes*. Selecting *Proprietary Yes* will program the FACP to allow remote programming downloads from the FS-Tools programming utility at all times without the need to access the FS-Tools Download screen. Refer to the table on page 46 for permissible settings.

Pressing 2 for *Accept Download* will cause the following screen to be displayed:



While this screen is displayed, remote programming downloads are allowed regardless of the Proprietary setting. Exiting this screen will disable any further downloads to the FACP. Also, following 30 minutes of inactivity (including up/downloading), the Accept Download screen will time-out, causing the display to return to the System Normal screen.

6.2 Transferring a Program

The first time that the control panel is downloaded (whether initiated at the jobsite or remotely), a secret code is loaded in by a Service Terminal. Future upload or download requests cause verification of the secret code by the control panel before processing of data is allowed. If the secret code is not verified, the control panel will terminate the request.

While the control panel is communicating with the Service Terminal, one of the DACT's red phone line active LEDs will turn on steady.

In order to download the panel (whether initiated at the jobsite or remotely), the following must be true:

- ✓ The control panel must be in the Normal Mode of operation. Downloading is not possible if the panel is in any other mode

- ✓ There cannot be any active communications ongoing with a Central Station receiver
- ✓ All active events must be successfully 'kissed-off' by the Central Station(s). The communicator must be in a standby state with no new information waiting to be transmitted to a Central Station

6.2.1 Security Features

Upload and download with the control panel have been carefully designed to include key security features to ensure proper functionality. Any time a transfer is initiated, the control panel and the Service Terminal will communicate and transfer data before contacting a Central Station. When the data transfers are completed and the control panel disconnects from the Service Terminal, the control panel will call the Central Station and report one of the following conditions:

- Upload/Download request received
- Upload and/or Download request successful
- Upload/Download failed

The key features are listed and explained in the following sections.

Secret Code Verification

A secret code is stored in the control panel by a Service Terminal to prevent unauthorized access. The secret code is created at the Service Terminal by the master user and cannot be viewed or changed by anyone other than a master user. Viewing of the secret code is prohibited at the control panel. Prior to allowing an upload or download of data, the control panel will verify the secret code transmitted by the Service Terminal.

Time-out at Control Panel

Upon answering an incoming call on the primary Central Station phone line, the control panel will listen for a modem connection signal. If this signal is not received within 50 seconds, the control panel will disconnect the call. Upon successful connection (secret code verified), if no communication occurs within 30 minutes, the panel will disconnect the call. Upon time-out, transfer activity will be reported to the Central Station (if enabled) and the connection will be terminated.

Error Checking

As each block of data is received by the control panel, it is checked for accuracy. If an error is detected, the block is retransmitted until correct, up to a maximum of four times. If the Secret Code is not verified and four errors occur, the call is disconnected and the report that the upload/download was not successful is called to the Central Station(s).

Central Station Data Protection

The primary and secondary Central Station phone numbers, communications format, account code, test time and programmable event codes are vital Central Station information. These blocks of data are protected from partial programming due to faulty phone connections, line noise and other errors. This prevents the panel from being confused due to a wrong phone number, account code, test time and most critical formatting errors.

Section 7: USB Upload/Download

Important! The FACP will automatically reset 2 minutes after completion of a user program download. To prevent program corruption, the operator must wait until this panel reset occurs before performing any panel operations.

CAUTION: After successfully downloading a program, make certain to perform the following steps:

1. Print out all programmed data via Print Mode or manually view programmed entries and compare to intended program data
2. Test all affected panel operations
3. Immediately correct any problems found

7.1 USB Upload/Download

NFPA 72 requirements state that a technician be on-site and at the control panel whenever the FS-Tools Programming Utility is used to download any information to the FACP. This applies to local and remote programming. For this reason, a new option has been added to the FACP which allows an individual at the FACP to enter a password and either enable the proprietary mode where downloading will be allowed at any time or access a specific password protected screen where downloading will be allowed regardless of the current proprietary setting.

The USB upload/download option allows for the transfer of programming information via a flash drive. The USB thumb drive must be in FAT32 file system format. This is typically the default format. Insert a USB flash drive into J20 on the bottom edge of the fire panel's circuit board. The USB Download option can be selected from the main menu screen as shown below:

```
1=READ STATUS MODE
2=PROGRAMMING MODE
3=FS TOOL UP/DOWNLOAD
4=USB UP/DOWNLOAD
```

Pressing 4 for USB Up/Download while viewing the main menu will cause the following screen to be displayed:

```
USB UP/DOWNLOAD
ENTER PASSWORD
*****
```

The USB Upload/Download password (default 22222222) must be entered to access the USB Upload/Download feature. Note that the default password can be changed using the Password Change option (refer to "Password Change" on page 95). Entering the correct password will cause the following screen to be displayed:

```
USB UP/DOWNLOAD
1=UPLOAD PROGRAM
2=DOWNLOAD PROGRAM
```

Pressing 1 for *Upload Program*, while viewing the USB Up/Download screen, will display the following.

```
UPLOAD TO USB
FILENAME:
```

Using the keypad and arrow keys, enter a name for the current FACP configuration to save to the USB drive, and then press Enter.

The following screen will be displayed while the program is sent to the USB drive:

```
USB UP/DOWNLOAD
SYSTEM CONFIGURATION
TRANSFER IN PROCESS
PLEASE WAIT
```

An error message will display if there is no USB drive inserted in the FACP or if there is an existing configuration saved on the drive with the same file name.

While this screen is displayed, USB programming uploads are allowed. Exiting this screen will disable any further uploads to a flash drive. Also, following 30 minutes of inactivity (including up/downloading), the Accept Upload screen will time-out, causing the display to return to the System Normal screen.

Similarly, the following screen will display when 2 for Download Program is pressed.

```
DOWNLOAD FROM USB
FILE: FS_50.cfg
1=NO
2=YES
```

Pressing 2 for *Yes* will cause the following screen to be displayed:



USB UP/DOWNLOAD
SYSTEM CONFIGURATION
TRANSFER IN PROCESS
PLEASE WAIT

An error message will display if there is no USB drive inserted in the FACP or if there is no existing configuration saved on the USB drive.

While this screen is displayed, local programming downloads are allowed. Exiting this screen will disable any further downloads to a flash drive. Also, following 30 minutes of inactivity (including up/downloading), the Accept Download screen will time-out, causing the display to return to the System Normal screen.

Important!

The program database created by the FS-Tools programming utility will be called, "FS_50.cfg" on the USB flash drive. Before loading the new database into the fire panel, the existing database will be saved as file, "FS_50.bak" on the USB flash drive. Only one new and one saved database can reside on the USB flash drive.

Section 8: Firmware Upgrade

In order to supply the latest features and functionality in fire alarm and life safety technology to our customers, we make frequent upgrades to the embedded software in our products. To ensure that you are installing and programming the latest features, we strongly recommend that you download the most current version of software for each product from www.notifier.com prior to commissioning any system. Contact Technical Support with any questions about software and the appropriate version for a specific application.

8.1 Firmware Upgrade

The Firmware Upgrade option can be selected from the main menu screen as shown below:



Panel Programming Screen #1



Panel Programming Screen #2

Pressing *1* for Firmware Upgrade while viewing Main Menu Screen #2 will cause the following screen to be displayed:



The Firmware Upgrade password (default 00000000) must be entered to access the Firmware Upgrade feature. Note that the default password can be changed using the Password Change option (refer to “Password Change” on page 95). Entering the correct password will cause the following screen to be displayed:



Pressing *1* for *Main Panel* will upgrade the software on the FACP. Pressing *2* for *SLC Loop Card* will update the firmware on the SLC Communication Loop Card. Pressing *3* will update the software for the *IPOTS-COM Communicator* (pre-installed). Pressing any option will cause the following screen to be displayed:



Before upgrading any software, the panel will give the option to save current programming to a flash drive. Press *1* for *No* to bypass programming backup or press *2* for *Yes* to save a copy of the current programming to the flash drive. The USB thumb drive must be in FAT32 file system format. This is typically the default format. An error message will display if there is not enough free memory space on the flash drive, if a backup was selected.

Insert the flash drive with the hardware upgrade downloaded from www.notifier.com into the USB port J20 on the bottom edge of the main panel circuit board. After the backup option screen, the following is an example of the main panel upgrade:



Press *1* for *No* to cancel or *2* for *Yes* to continue with the panel upgrade. The following screen will display if *Yes* is selected.



If the following error message displays, ensure the flash drive is inserted at J20 and it is fully seated.



The following error message will display if the upgrade file is not found on the flash drive. Ensure the file is present and it is a valid file for the type of hardware being updated.



Notes

Section 9: Power Supply Calculations

9.1 Overview

This section contains instructions and tables for calculating power supply currents in alarm and standby conditions. This is a four-step process, consisting of the following:

1. Calculating the total amount of AC branch circuit current required to operate the system
2. Calculating the worst-case system current load on the control panel, when primary (AC) power is applied, to assure that the limit of the its internal power supply will not be exceeded. This considers the fire alarm condition only.
3. Calculating the total current load on the batteries (secondary power source) in the event of an AC power loss. This considers both standby and fire alarm conditions.
4. Calculating the size of the batteries required to support the system if AC power loss occurs, based on the total battery current load, plus a regulatory agency mandated derating factor.

9.2 Calculating the AC Branch Circuit

The control panel requires connection to a separate, dedicated AC branch circuit, which must be labeled **FIRE ALARM**. This branch circuit must connect to the line side of the main power feed of the protected premises. No other non-fire alarm equipment may be powered from the fire alarm branch circuit. The branch circuit wire must run continuously, without any disconnect devices, from the power source to the control panel. Overcurrent protection for this circuit must comply with Article 760 of the National Electrical Codes as well as local codes. Use 14 AWG (2.00 mm²) wire with 600 volt insulation for this branch circuit.

Use Table 9.1, to determine the total amount of current, in AC amperes (A), that must be supplied to the system.

Device Type	Number of Devices		Current Draw (AC amps)		Total Current per Device
NFW-50X	1	X	1.75	=	
CHG-75	[]	X	2.05	=	
CHG-120	[]	X	2.00	=	
	[]	X	[]	=	
Sum Column for AC Branch Current Required				=	

Table 9.1 AC Branch Circuit Requirements

9.3 Calculating the System Current Load

9.3.1 Overview

The control panel's internal power supply must support all connected devices while primary (AC) power is applied. The continuous system current load is highest during a fire alarm condition. To calculate the fire alarm load on the internal power supply, use Calculation Column 1 in Table 9.3 on page 126.

The secondary power source (batteries) must be able to power the system under both standby and fire alarm conditions upon loss of primary (AC) power. To calculate the fire alarm load on the secondary power source, use Calculation Column 2 in Table 9.3 on page 126. To calculate the standby load on the secondary power source, use Calculation Column 3 in Table 9.3 on page 126.

All currents are given in amperes (A). Table 9.2 shows how to convert milliamperes and microamperes to full amperes.

To convert...	Multiply	Example
Milliamperes (mA) to amperes (A)	mA x 0.001	3 mA x 0.001 = 0.003A
Microamperes (µA) to amperes (A)	µA x 0.000001	300 µA x 0.000001 = 0.0003 A

Table 9.2 Converting to Full Amperes

9.3.2 How to Calculate System Current Load

Use Table 9.3 on page 126 to calculate current load as follows:

1. Enter the quantity of devices in all three columns.
2. Enter the current draw where required. Refer to the Device Compatibility Document and SWIFT Manual for compatible devices and their current draw.
3. Calculate the current draws for each in all columns.
4. Sum the currents for each column. This is the total load.
5. Verify that the total from Column 1 is less than or equal to the value specified in the note.
6. Copy the totals from Column 2 and Column 3 to Table 9.4 on page 127.

Table 9.3 contains columns for calculating current load. For each column, calculate the current and enter the total (in amperes) in the bottom row. When finished, copy the totals from Calculation Column 2 and Calculation Column 3 to Table 9.4 on page 127. For maximum output current available per circuit and per panel, refer to Section 1.2, "Specifications", on page 13.

Device Type	Calculation Column 1 Primary (AC) Power Source Fire Alarm Current (amps)			Calculation Column 2 Secondary (Battery) Power Source Fire Alarm Current (amps)			Calculation Column 3 Secondary (Battery) Power Source Standby Current (amps)		
	Qty	X[current draw]=	Total	Qty	X [current draw]=	Total	Qty	X [current draw]=	Total
Main Circuit Board ¹				1	X[0.257]=		1	X[0.141]=	
IPTS-COM Communicator	[]	X[0.041]=		[]	X[0.041]=		[]	X[0.040]=	
CELL-MOD/CAB-N	[]	X[0.100]=		[]	X[0.100]=		[]	X[0.055]=	
N-ANN-80	[]	X[0.040]=		[]	X[0.040]=		[]	X[0.015]=	
N-ANN-100	[]	X[0.025]=		[]	X[0.025]=		[]	X[0.020]=	
N-ANN-(R)LED	[]	X[0.068]=		[]	X[0.068]=		[]	X[0.028]=	
N-ANN-RLY	[]	X[0.075]=		[]	X[0.075]=		[]	X[0.015]=	
N-ANN-I/O	[]	X[0.200]=		[]	X[0.200]=		[]	X[0.035]=	
N-ANN-S/PG	[]	X[0.045]=		[]	X[0.045]=		[]	X[0.045]=	
4XTM	[]	X[0.011] ² =		[]	X[0.011]=		[]	X[0.005]=	
4-wire Detector Heads	[]	X[]=		[]	X[] ³ =		[]	X[]=	
Power Supervision Relays ⁴	[]	X[0.025]=		[]	X[0.025]=		[]	X[0.025]=	
NI-100, FSI-851							[]	X[0.00030]=	
NP-100, NP-200, FSP-851, FSP-951							[]	X[0.00030]=	
NP-100T, NP-200T, FSP-851T, FSP-951T							[]	X[0.00030]=	
NP-A100, FAPT-851							[]	X[0.00030]=	
NH-100, NH-200, FST-851, FST-951							[]	X[0.00030]=	
NH-100R, NH-200R, FST-851R, FST-951R							[]	X[0.00030]=	
NH-100H, NH-200H, FST-851H, FST-951H							[]	X[0.00030]=	
ND-100, FSD-751PL							[]	X[0.00030]=	
ND-100R, FSD-751RPL							[]	X[0.00030]=	
B501BH & B501BHT ⁵							[]	X[0.001]=	
B224RB							[]	X[0.00050]=	
B224BI							[]	X[0.00045]=	
NMM-100, FMM-1							[]	X[0.00040]=	
XP10-M							[]	X[0.00350]=	
NDM-100, FDM-1							[]	X[0.00075]=	
NMM-100P, FMM-101							[]	X[0.000375]=	
NZM-100, FZM-1							[]	X[0.00027]=	
NZM-100-6, XP6-MA							[]	X[0.00200]=	
NOT-BG-12LX, NBG-12LX							[]	X[0.00030]=	
NC-100/FCM-1							[]	X[0.00039]=	
XPC-6							[]	X[0.00225]=	
NC-100R/FRM-1							[]	X[0.00027]=	
XPR-6							[]	X[0.00145]=	
N-100ISO, ISO-X							[]	X[0.00040]=	
ISO-6							[]	X[0.00045]=	
FWSG							[]	X[0.040] or [0.024] ⁶	
NAC #1 ⁷	[]	X[]=		[]	X[]=				
NAC #2 ⁷	[]	X[]=		[]	X[]=				
FCPS (remote sync)	[]	X[0.02]=		[]	X[0.0217]=				
Current Draw from TB3	[]	[]=		[]	[]=		[]	[]=	
Sum each column for totals	AC Powered, Fire Alarm Load ⁸ =			Battery Powered, Fire Alarm Load ⁹ =			Battery Powered, Standby Load ¹⁰ =		

Table 9.3 System Current Load Calculations

- 1 Main board with display only.
- 2 If using the Reverse Polarity Alarm output, add 0.005 amps; if using the Reverse Polarity Trouble output, add another 0.005 amps.
- 3 Refer to the Device Compatibility Document for standby current.
- 4 Must use compatible listed Power Supervision Relay.
- 5 Maximum alarm current for each sounder base is 0.015 amps which must be supplied by aux. 24VDC source.
- 6 When powered by an external source, use 0.040A. When powered by the SLC, use 0.024A.

- 7 If using Gentex brand NACs, the max number of devices for each NAC output is 35. The "UL Max" current rating, published in their data sheets, must be used in order to maintain performance under low battery conditions with the maximum wire resistances shown in Table D.2 on page 139.
- 8 Total Alarm current load cannot exceed 3.0 amps.
- 9 When AC power is initially applied to the panel and the battery is not fully charged, an initial charge current of up to 5.3 amps may be observed at the battery. This high current is only applied for a very short duration (milliseconds) and does not affect system load or battery size calculations.
- 10 Total Standby current load cannot exceed 2.25 amps.

9.4 Calculating the Battery Size

Use Table 9.4 to calculate the total Standby and Alarm load in ampere hours (AH). This total load determines the battery size (in AH), required to support the system upon loss of primary (AC) power. Complete Table 9.4 as follows:

1. Enter the totals from Table 9.3 on page 126, Calculation Columns 2 and 3 where shown
2. Enter the NFPA Standby and Alarm times (refer to 'NFPA Requirements' below)
3. Calculate the ampere hours for Standby and Alarm, then sum the Standby and Alarm ampere hours
4. Multiply the sum by the derating factor of 1.2 to calculate the proper battery size (in AH)
5. Write the ampere hour requirements on the Protected Premises label located inside the cabinet door

Total Standby Load, Battery Powered (from Table 9.3 Calculation Column 3) []	Required Standby Time (24 hours) X[]	= AH
Total Fire Alarm Load, Battery Powered (from Table 9.3 Calculation Column 2) []	Required Alarm Time (for 5 min., enter 0.084, for 10 min., enter 0.168) X[]	= AH
Sum of Standby and Alarm Ampere Hours		= AH
Multiply by the Derating Factor		X 1.2
Battery Size, Total Ampere Hours Required		= AH

Table 9.4 Total Secondary Power Requirements at 24 VDC

9.4.1 NFPA Battery Requirements

NFPA 72 Local, Proprietary, Central, Auxiliary and Remote Fire Alarm Systems require 24 hours of standby power followed by 5 minutes in alarm.

9.4.2 Selecting and Locating Batteries

Select sealed lead acid batteries that meet or exceed the total ampere hours calculated in Table 9.4 . The control panel can charge batteries in the 7 AH to 18 AH range. The control panel cabinet is capable of housing batteries up to 18 AH. Batteries larger than 18 AH require a UL listed external battery charger and cabinet such as the BB-26, NFS-LBB or other UL listed external battery cabinet.

Appendix A: Software Zones

A.1 Correlations

Setup and configuration of an addressable system is different than a conventional system. In a conventional system, assignment of input devices (smoke detectors, pull stations, heat detectors, etc.) to zones is accomplished through wiring. The wiring is direct from clearly marked panel terminals to any device assigned to a particular zone. Connection of output devices (horns, bells, strobes, etc.) in a conventional system is accomplished by direct wiring of the output devices to Notification Appliance Circuit terminals.

In an addressable system, a minimum of a single pair of wires (SLC communication loop) is used to connect all addressable input and output devices. Communications between the FACP (Fire Alarm Control Panel) and all addressable devices takes place over the wire pair which originates from the FACP. Software programming is used to configure the system as opposed to direct wiring. Zone assignments are created via software means, hence the term *software zones*.

Setup of an NFW-50X software zone is accomplished by panel programming. Each addressable device can be assigned to a maximum of five software zones. Each software zone, however, may have from 1 to 50 addressable input and output devices assigned to it.

Monitor modules, control modules and detectors comprise a group of 50 addresses, each device having a unique address from 1 to 50. Be careful not to duplicate addresses between devices. Refer to the following page for an example of zoning.

In the example on the following page:

- Zone 01 has the following addressable devices assigned to it:
 - ✓ smoke detectors with addresses 01 and 02
 - ✓ monitor module with address 03
 - ✓ monitor module with address 04 and 05
 - ✓ control modules with addresses 06, 07, 10, 11, and 13
- Zone 02 has the following addressable devices assigned to it:
 - ✓ monitor module with addresses 04 and 05
 - ✓ smoke detectors with addresses 15 and 16
 - ✓ control modules with addresses 20, 11, and 21
- Zone 03 has the following addressable devices assigned to it:
 - ✓ smoke detectors with addresses 22, 24, and 25
 - ✓ control module with address 30
 - ✓ control modules with addresses 11, 31, and 32

The example points out some of the key assignment features of the NFW-50X. Addresses of detectors, monitor modules and control modules are not duplicated. The control module with address 11 is assigned to three software zones (providing floor above and floor below). Be careful to properly plan the installation prior to installing any devices.

Correlation of Input and Output Zones

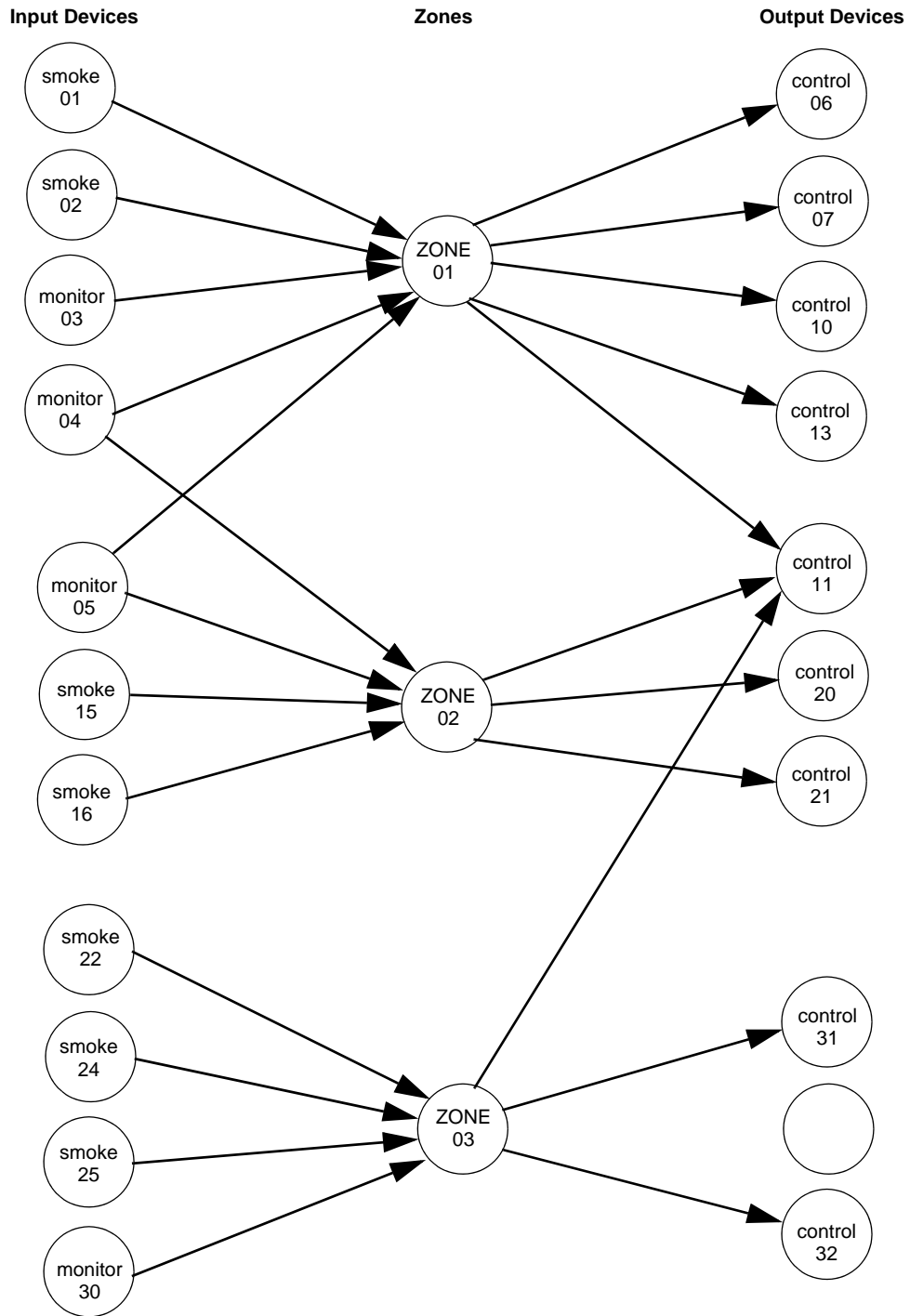

The zone correlations which are shown graphically above are also presented in Table A.1 on page 130.

ADDRESSABLE DEVICE ZONE ASSIGNMENT			
Address	Device Type	Zone Number	ADJ/NOUN
01	smoke detector	1	FIRST HALL
02	smoke detector	1	ELEV. LOBBY
03	monitor module	1	
04	monitor module	1, 2	
05	monitor module	1, 2	
06	control module	1	
07	control module	1	
08			
09			
10	control module	1	
11	control module	1, 2, 3	
12			
13	control module	1	
14			
15	smoke detector	2	2ND FLOOR
16	smoke detector	2	ROOM 210
17			
18			
19			
20	control module	2	
21	control module	2	
22	smoke detector	3	3RD FLOOR
23			
24	smoke detector	3	MEZZANINE
25	smoke detector	3	MECH. ROOM
26			
27			
28			
29			
30	monitor module	3	
31	control module	3	
32	control module	3	
33			
34			
35			
36			
37			
38			
39			
40			
41			
42			
43			
44			
45			
46			
47			
48			
49			
50			

Table A.1 Detector Programming Sheet Example

ADDRESSABLE DEVICE ZONE ASSIGNMENTS			
Address	Device Type	Zone Number	ADJ/NOUN
01			
02			
03			
04			
05			
06			
07			
08			
09			
10			
11			
12			
13			
14			
15			
16			
17			
18			
19			
20			
21			
22			
23			
24			
25			
26			
27			
28			
29			
30			
31			
32			
33			
34			
35			
36			
37			
38			
39			
40			
41			
42			
43			
44			
45			
46			
47			
48			
49			
50			

Table A.2 Blank Programming Sheet

ADDRESSABLE DEVICE ZONE ASSIGNMENTS			
Address	Device Type	Zone Number	ADJ/NOUN
01			
02			
03			
04			
05			
06			
07			
08			
09			
10			
11			
12			
13			
14			
15			
16			
17			
18			
19			
20			
21			
22			
23			
24			
25			
26			
27			
28			
29			
30			
31			
32			
33			
34			
35			
36			
37			
38			
39			
40			
41			
42			
43			
44			
45			
46			
47			
48			
49			
50			

Table A.3 Blank Programming Sheet

Appendix B: Default Programming

The following table provides a list of the programming options and their factory default settings.

Program Option	Factory Default	Program Option	Factory Default
Detector Programming	Not Installed	Waterflow Silenceable	No
Detector Type	Smoke-Photo	Relay 1	Alarm
Detector Verification	Off	Relay 2	Trouble (fixed)
Detector Walktest	Yes	Relay 3	Supervisory
Detector PAS	No	Communicator Installed	Yes
Detector Presignal	No	POTS, Ethernet, Cellular Enabled	No
Detector Zone Assign.	000 only	Ethernet, Cellular Location ID	0000
Detector Adj/Noun	none	Ethernet, Cellular CS ID	0000
Module Programming	Not Installed	POTS, Ethernet, Cellular Account Code	000000
Module Type	Monitor	POTS Enabled	No
Module Walktest	Yes	POTS Type	Touchtone
Module Presignal	No	POTS Supervised	No
Module Zone Assign.	000 only	Gains Dialing	Normal
Module Adj/Noun	none	Gains Reporting	Normal
Module Control Module Delay	No	IP Settings- DHCP	Enabled
Zone Type	Alarm Zone	Trouble Report Limit	0
Zone 000 Enable	Enabled	Report Style	Point
Zone 001 Enable	Enabled	AC Loss Delay	2
Zone 002 Enable	Enabled	Primary Account Code	000000
Zone 003 Enable	Enabled	Secondary Account Code	000000
.....through.....	Test Time	0100
Zone 045 Enable	Enabled	Primary Phone Number	
Special Purpose Zones 046-049	Off	Secondary Phone Number	
Loop Class	Class B	Primary Comm Format	Ademco Contact ID
Loop Protocol	LITESPEED	Secondary Comm Format	Ademco Contact ID
Trouble Reminder	24 Hr	ANN-Primary Enabled	No
Banner		ANN-Primary Modules Addr. 1 - 8	None
Time Format	12 Hr	ANN-Secondary Enabled	No
Hours Setting	12	ANN-Secondary Modules Addr. 1 - 8	None
Minutes Setting	00	ANN-S/PG Port	Serial
Second Settings	00	ANN-S/PG Baud	9600
AM-PM Setting	AM	ANN-S/PG Data Bits	7
Month Setting	01	ANN-S/PG Parity	Even
Day Setting	01	ANN-S/PG Stop Bits	1
Year Setting	00	ANN-S/PG Offline Timer	60
Daylight Savings	Enabled	ANN-S/PG Printer Supervision	No
Month Start Daylight Savings	April	ANN-80/100 Piezo Enabled	Yes
Week Start Daylight Savings	Week 2	ANN-80/100 Lock Enabled	Yes
Month End Daylight Savings	November	ANN-80/100 Acknowledge Button Enabled	Yes
Week End Daylight Savings	Week 1	ANN-80/100 Silence Button Enabled	Yes
Alarm Verification	Off	ANN-80/100 Reset Button Enabled	Yes
PAS Timer	0	ANN-80/100 Drill Button Enabled	Yes
Presignal Timer	0	ANN-I/O Point/Zone	Zone
Waterflow Retard Timer	0	ANN-I/O Range	00-29
Control Module Delay Timer	0	ANN-I/O Active LEDs Only	
NAC 1 & 2 Enable	Enabled	ANN-RLY Relay 1	Zone 1
NAC 1 & 2 Silenceable	Yesthrough.....
NAC 1 & 2 Type	Strobe Sync	ANN-RLY Relay 10	Zone 10
NAC 1 & 2 Sync Type	System Sensor	ANN-LED Point/Zone	Zone
NAC 1 & 2 Autosilence	0	ANN-LED Alarms/ATS (Alarm, Trbl, Supv)	ATS
NAC 1 & 2 Coding	Steady	ANN-LED Range	0 - 9
NAC 1 & 2 Zones	Zone 000 only	F1 - F4 function keys	Disabled
NAC 1 & 2 Silence Inhibit	No	Master Password	00000000
Charger Enabled	Yes	Maintenance Password	11111111
4XTM Supervision	No	Upload/Download Password	22222222
Remote Sync Enabled	Yes		
Aux Power Class A	No		
Aux Power Resettable	No		
Canadian Option Enabled	No		

Appendix C: NFPA Standard-Specific Requirements

The NFW-50X has been designed for use in commercial, industrial, and institutional applications and meets the requirements for service under the National Fire Protection Association (NFPA) Standards outlined in this Appendix. The minimum system components required for compliance with the appropriate NFPA standard are listed below:

NFW-50X Control Panel

Contains the main control board, cabinet (backbox and door), main power supply transformer and power supply.

Batteries

Refer to “Power Supply Calculations” on page 125, for Standby Power Requirements.

Initiating Devices

Connected to one of the control panel's Initiating Device Circuits.

Notification Appliances

Connected to the control panel's Notification Appliance Circuits via a control module.

The following additional equipment is needed for compliance with the NFPA 72 standards listed below:

NFPA 72 NATIONAL FIRE ALARM STANDARDS FOR:

NFPA 72 Central Station Service (Protected Premises Unit) or Remote Station Service

Onboard Digital Alarm Communicator Transmitter for connection to a compatible listed Central Station DACR or Protected Premises Receiving Unit. This unit must be installed as outlined in “Components” on page 15.

OR

4XTM Transmitter Module for connection to the RS82 Remote Station Receiver. See Figure C.2, “Remote Station Connection Using 4XTM Module,” on page 135, for installation instructions for this unit.

NFPA 72 Auxiliary Fire Alarm System

4XTM Transmitter Module for connection to a compatible listed Local Energy Municipal Box. This unit must be installed as illustrated in the section titled “4XTM Transmitter Module Installation” on page 29 and as outlined in Figure C.1, “Municipal Box Connected to 4XTM Transmitter Module” on page 134.

NFPA 72 Proprietary Fire Alarm System

NFW-50X Alarm, Trouble and Supervisory contacts connected to Transmitter(s). See Figure C.3, “Proprietary Protective Signaling System,” on page 136, for installation instructions for this unit.

NFPA 72 Auxiliary Fire Alarm System

All connections are power-limited and supervised. This application is not suitable for separate transmission of sprinkler supervisory or trouble conditions.

Notes:

1. 3 ohms maximum loop resistance allowed for wiring from control panel to Municipal Box.
2. Cut JP3 on the NFW-50X main circuit board to supervise placement of 4XTM module and circuit.
3. Cut JP2 on the NFW-50X main circuit board to enable FACP Supervisory relay.
4. Refer to “4XTM Transmitter Module Installation” on page 29 for detailed information.

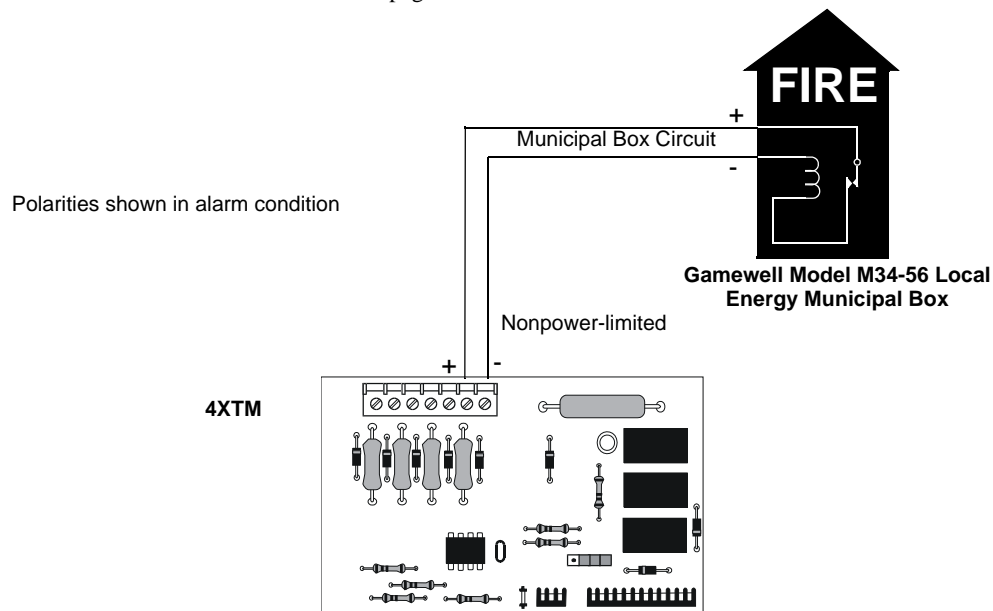

Figure C.1 Municipal Box Connected to 4XTM Transmitter Module

NFPA 72 Remote Station Protective Signaling System

Notes:

1. Cut Jumper JP3 on the NFW-50X main circuit board to supervise placement of the 4XTM module.
2. Refer to “4XTM Transmitter Module Installation” on page 29 for detailed information.

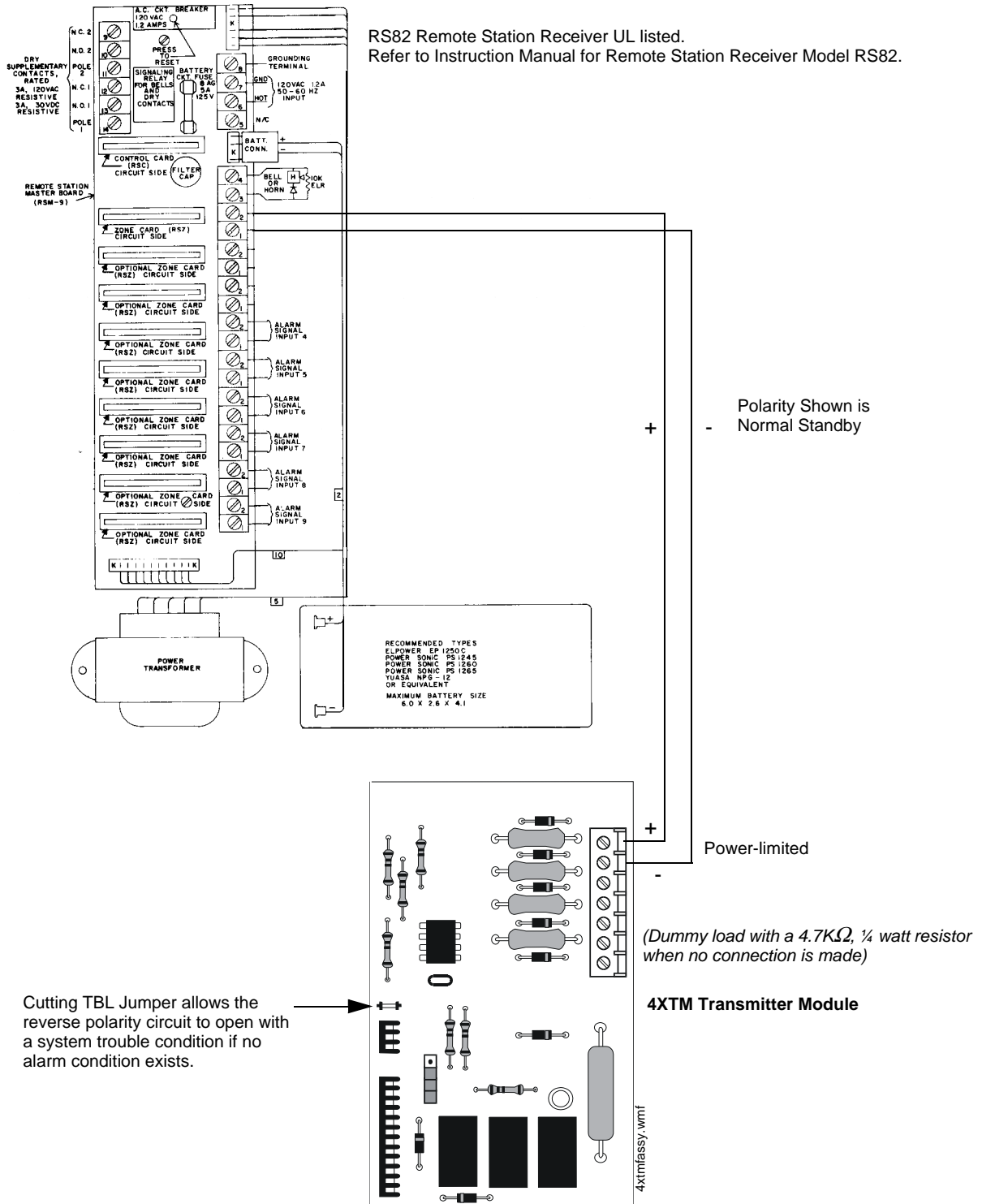
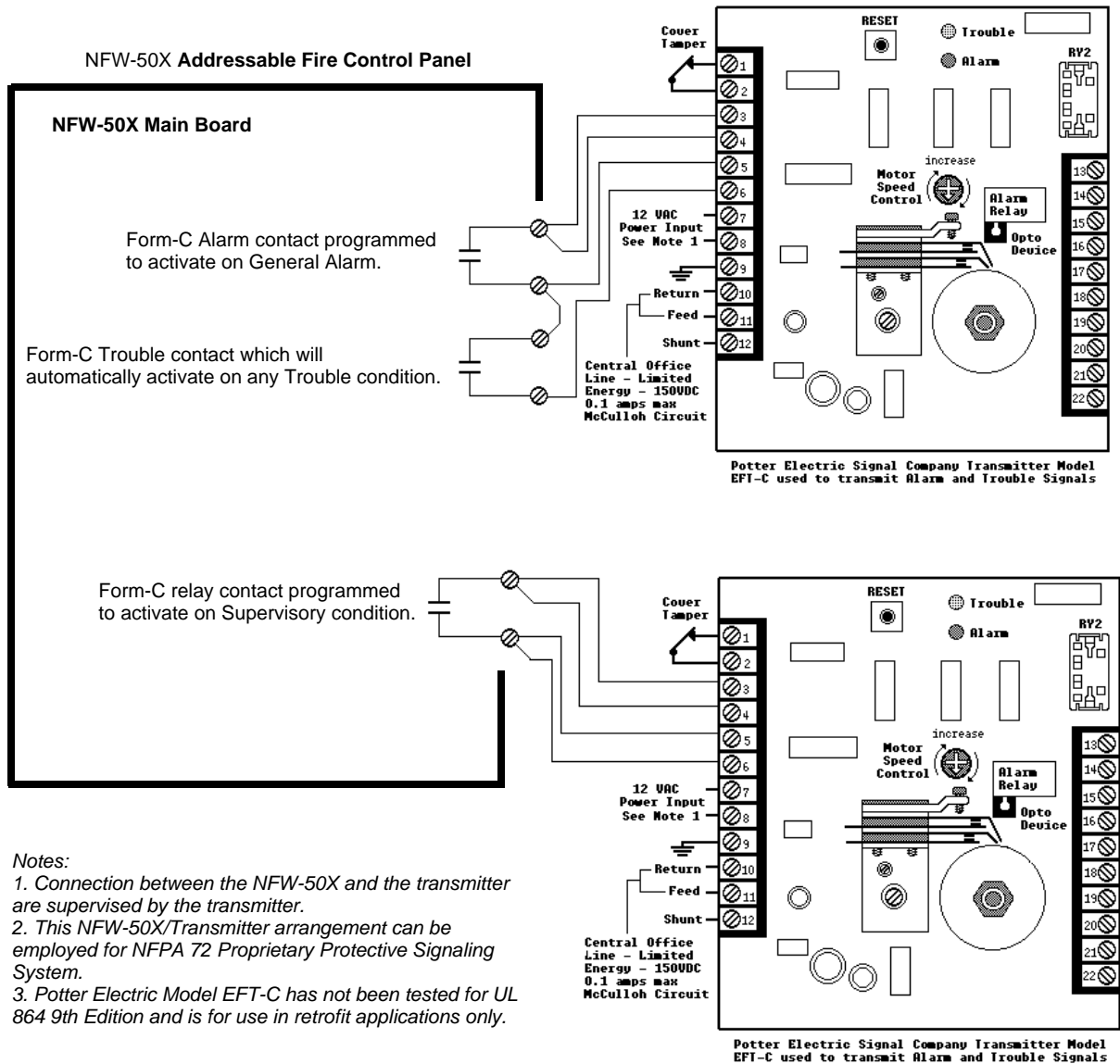

Figure C.2 Remote Station Connection Using 4XTM Module

NFPA 72 Proprietary Protective Signaling Systems



- Notes:
1. Connection between the NFW-50X and the transmitter are supervised by the transmitter.
 2. This NFW-50X/Transmitter arrangement can be employed for NFPA 72 Proprietary Protective Signaling System.
 3. Potter Electric Model EFT-C has not been tested for UL 864 9th Edition and is for use in retrofit applications only.

Figure C.3 Proprietary Protective Signaling System

C.1 MBT-1 Municipal Box Trip - Silenceable

The following figure illustrates the connection of the MBT-1 (Municipal Box Trip) between the FACP and a Local Energy Municipal Box. The use of an addressable control module programmed for *General Alarm* and *Silenceable* allows silencing of the Municipal Box without resetting the panel or box.

The addressable Control Module must be programmed as *Silenceable* and *General Alarm*.

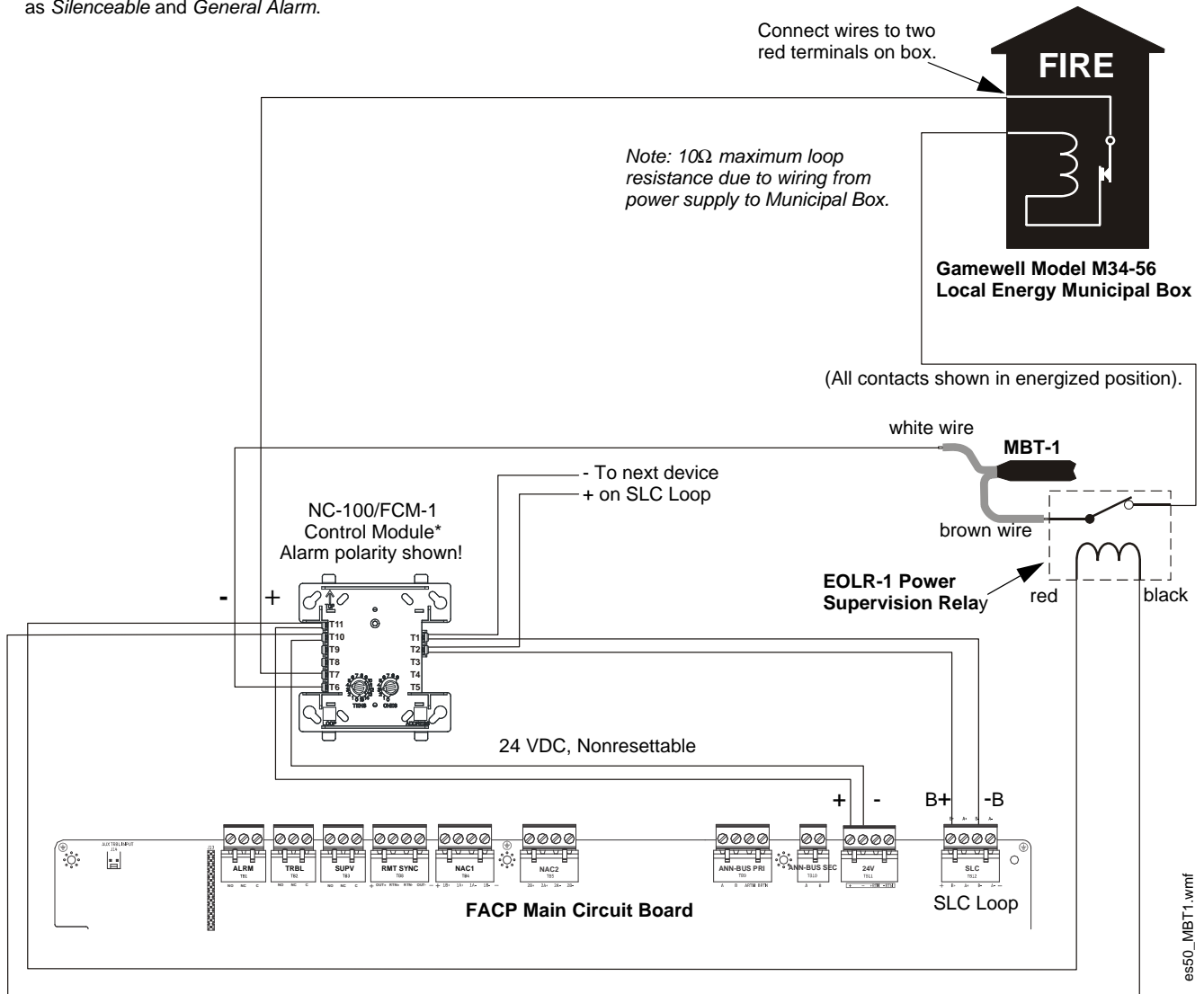

*If the SLC device does not match the one in this figure, refer to the FireWarden SLC manual wiring conversion charts for legacy and newer versions of the modules.

Figure C.4 MBT-1 Silenceable

Appendix D: Wire Requirements

T-tapping of the SLC loop wiring is allowed for 2-wire (Class B) configurations. The total resistance of any branch cannot exceed 40 ohms. The total wire length of all branches cannot exceed 10,000 feet (3,000 m).

Connecting external system accessories to the NFW-50X main circuits must be carefully considered to ensure proper operation. It is important to use the correct type of wire, gauge and run length for each NFW-50X circuit. Reference the chart below to specify wire requirements and limitations for each NFW-50X circuit.

Note:

1. If the SLC loop is to be run in conduit with Notification Appliance Circuits, the risk of encountering problems can be greatly reduced by exclusively employing electronic sounders instead of more electronically noisy notification appliances such as electromechanical bells or horns.
2. The SLC can be programmed to operate in FlashScan mode (displayed as “LiteSpeed”, factory default setting) for a quicker device response time. While shielded wire is not required in FlashScan mode, it is recommended that all SLC wiring be twisted-pair to minimize the effects of electrical interference. Use the following table to determine the specific wiring requirements for the SLC when unshielded wire is used:

Refer to Table D.1 on page 138 and Table D.2 on page 139 for wiring requirements.

CIRCUIT CONNECTIONS		WIRE REQUIREMENTS		
Circuit Type	Circuit Function	Wire Type and Limitations	Recommended Max. Distance Feet (meters)	Wire Gauge and Compatible Brands
SLC loop (power-limited)	Connects to Addressable Devices	Twisted, shielded pair 40 ohms maximum per length of Class A loops. 40 ohms per branch maximum for Class B loops	10,000 (3,000 m)	12 AWG (3.25 mm ²): Genesis 4410, Signal 98230, Belden 9583, WPW999 14 AWG (2.00 mm ²): Genesis 4408 & 4608 Signal 98430, Belden 9581, WPW995 16 AWG (1.30 mm ²): Genesis 4406 & 4606 Signal 98630, Belden 9575, WPW991 <u>Direct Burial Cable</u> Isotec NP713110VNQ-S 18 AWG (0.75 mm ²): Genesis 4402 & 4602 Signal 98300, Belden 9574, WPW975 <u>Direct Burial Cable</u> Isotec NP714110VNQ-S
	CLIP MODE		8,000 (2,400 m) 4,875 (1,450 m) 3,225 (980 m)	
	FLASHSCAN MODE	Twisted, unshielded pair 40 ohms maximum per length of Class A loops. 40 ohms per branch maximum for Class B loops	10,000 (3,000 m) 8,000 (2,400 m) 4,875 (1,450 m) 3,225 (980 m)	12 AWG (3.25 mm ²): Belden 5020UL & 6020UL, Genesis WG-4315 & WG-4515 14 AWG (2.00 mm ²): Belden 5120UL & 6120UL, Genesis WG-4313 & WG-4513 16 AWG (1.30 mm ²): Belden 5220UL & 6220UL, Genesis WG-4311 & WG-4511 18 AWG (0.75 mm ²): Belden 5320UL & 6320UL, Genesis WG-4306 & WG-4506
		Untwisted, unshielded pair ¹	3,000 (900 m)	12-18 AWG (3.25 - 0.75 mm ²) using listed wire
ANN-BUS (EIA-485) (power-limited)	Connects to annunciator modules/	Twisted pair Maximum loop wire resistance is 2 ohms for power and 40 ohms for data	6,000 (1,800 m)	Refer to “ANN-BUS Wiring” on page 31 for information on device wiring
monitor module (power-limited)	Initiating Device Circuit: Contact Closure	Maximum loop wire resistance is 1500 ohms	2,500 (760 m)	12-18 AWG (3.25 - 0.75 mm ²)
monitor module (power-limited)	Initiating Device Circuit: Two-wire Modules	No more than a 2.4 volt drop allowed at end of circuit. Maximum loop wire resistance is 25 ohms	2,500 (760 m)	12-18 AWG (3.25 - 0.75 mm ²)
control module (power-limited)	Notification Appliance Circuit	In alarm, no more than a 1.2 volt drop allowed at end of circuit	Distance limitation set by 1.2 volt maximum line drop	12-18 AWG (3.25 - 0.75 mm ²)
Remote Sync Output	Provides strobe and normal sync for remote NAC power supplies	Untwisted, unshielded pair wire	Distance set by 295 ohm resistance limitation	12-18 AWG (3.25 - 0.75 mm ²)

Table D.1 FACP Wire Specifications

¹ When using untwisted, unshielded wire, full conduit is recommended for optimum EMI/RFI protection.

D.1 NAC Wiring

The following table lists NAC wiring requirements for the FACP.

NAC Load (Amps)	Max. allowable total loop resistance (ohms)	CLASS-B Max. allowable wire pair length (feet)				CLASS-A Max. allowable wire pair length (feet)			
		AWG 12 solid	AWG 14 solid	AWG 16 solid	AWG 18 solid	AWG 12 solid	AWG 14 solid	AWG 16 solid	AWG 18 solid
0.25	14.40	4450	2797	1756	1105	2225	1399	878	553
0.5	7.20	2225	1399	878	553	1112	699	439	276
0.75	4.80	1483	932	585	368	742	466	293	184
1	3.60	1112	699	439	276	556	350	220	138
1.25	2.88	890	559	351	221	445	280	176	111
1.5	2.40	742	466	293	184	371	233	146	92
1.75	2.06	636	400	251	158	318	200	125	79
2	1.80	556	350	220	138	278	175	110	69
2.25	1.60	494	311	195	123	247	155	98	61
2.5	1.44	445	280	176	111	222	140	88	55

Table D.2 NAC Wiring Requirements for FACP

Notes:

1. Calculations are based on Direct-Current Resistance data for **uncoated copper wire**, per National Electrical Code (2011 Edition) Table 8, Conductor Properties.
2. These distances reflect the worst case scenario and are based on the current draw of the highest candela strobes at the low end of the supported NAC voltage with the entire load at the end of the circuit. Further distances can be achieved by performing a point-to-point voltage calculation that more accurately reflects the specific devices used and how they are dispersed on the circuit.
3. If using Gentex brand notification appliances, the “UL Max” current rating published in their data sheets, must be used in order to maintain performance under low battery conditions with the maximum wire resistances shown in the table above.

Appendix E: HVAC Control

The FACP can be programmed to shut down a building's HVAC fans in the event of a fire. The fans cannot be restarted until the fire alarm condition has been cleared and the FACP has been reset to a normal (non-alarm) condition.

IMPORTANT! This HVAC feature is *not* to be used for smoke control. It is only designed to shut down fans during an alarm condition.

E.1 Control Module Operation

E.1.1 HVAC SHUTDOWN

The **HVAC SHUTDOWN** type code can be assigned to any addressable control relay module for the purpose of shutting down HVAC fans during a fire alarm, duct supervisory, photo supervisory, CO alarm, or CO supervisory condition. Devices connected to a module with this type code are unsupervised. To program this feature in the FACP:

- Program the **HVAC SHUTDN** type code to the control module which will be used to shut down the fans (refer to *Type* under the section titled, "Edit Module Screen for Control Modules" on page 62).
- Program the control module to a software zone and program fire alarm, duct supervisory, photo supervisory, CO alarm, or CO supervisory input devices which, when activated, are to cause fan shutdown to the same software zone (refer to *Zone Assignment* under the section titled, "Edit Module Screen for Control Modules" on page 62).
- If using a relay control module for HVAC shutdown, monitor the state of the control module using an addressable monitor module programmed for *Trouble Monitor*. (Refer to *Type Monitor* under section titled, "Edit Module Screen for Monitor Module" on page 57). The monitor module's display label must be programmed to display HVAC SHUTDOWN. When a shutdown event occurs, the control module will both shut down the fans and activate the monitor module. When the control module is active, the monitor module will indicate a trouble condition at the FACP along with the label HVAC SHUTDOWN.

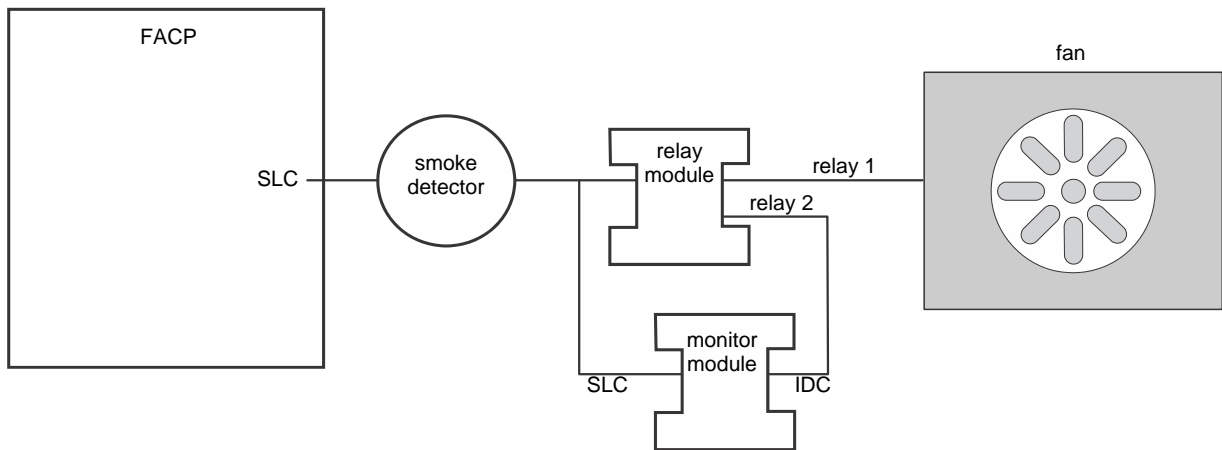

Figure E.1 HVAC RLY Shutdown

- If using a NAC control module for HVAC shutdown, monitor the state of the control module using an addressable monitor module programmed for *Trouble Monitor* and an MR Series relay (MR-101CR). (Refer to *Type Monitor* under the section titled, "Edit Module Screen for Monitor Module" on page 57). The monitor module's display label must be programmed to display HVAC SHUTDOWN. When a shutdown event occurs, the control module will activate the MR Series relay which, in turn, will both shut down the fans and activate the monitor module. When the control module and the MR series relay are active, the monitor module will indicate a trouble condition at the FACP along with the label HVAC SHUTDOWN. Note that the 24 VDC power used by the control module must be supervised using another addressable monitor module and an EOLR-1 power supervision relay.

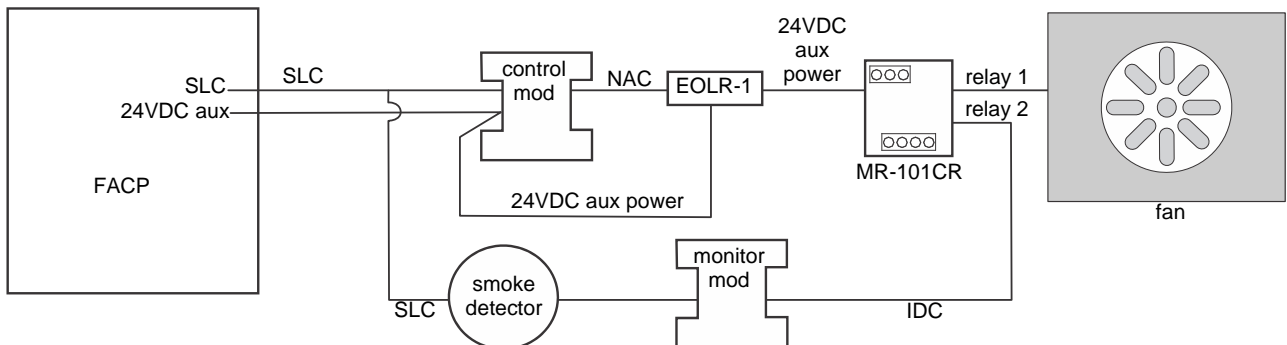

Figure E.2 HVAC NAC Shutdown

Once activated, the HVAC SHUTDOWN control module remains activated, even if the FACP is silenced or reset. After all the fire alarms, duct supervisories, photo supervisories, CO alarms, and CO supervisory conditions on the FACP have been cleared and the panel reset, the HVAC SHUTDOWN control module remains activated and the fans remain off. The fans can only be restarted when the HVAC SHUTDOWN control module is deactivated by the HVAC RESTART module.

E.2 Monitor Module Operation

E.2.1 HVAC RESTART

The **HVAC RESTART** type code can be assigned to any addressable monitor module for the purpose of resetting (deactivating) the HVAC SHUTDN control module and turning the fan back on. The **HVAC RESTART** monitor module acts globally throughout the FACP system and therefore, is not programmed to a particular zone. To program this feature in the FACP:

- Program the **HVAC RESTART** type code to a monitor module which will be used to deactivate the HVAC SHUTDN control module and restart the fans (refer to *Type Monitor* under the section titled, “Edit Module Screen for Monitor Module” on page 57).

The HVAC RESTART monitor module does not latch when activated. Pressing a switch connected to the monitor module will deactivate the HVAC SHUTDN control relay module *only if there no alarm conditions present*. The HVAC SHUTDN control relay module can be deactivated if trouble conditions exist on the FACP.

E.2.2 HVAC OVERRIDE

The **HVAC OVERRIDE** type code can be assigned to any addressable monitor module for the purpose of overriding or preventing the HVAC SHUTDN control modules from activating. The **HVAC OVERRIDE** monitor module acts globally throughout the FACP system and therefore, is not programmed to a particular software zone. To program this feature in the FACP:

- Program the **HVAC OVERRIDE** type code to the monitor module which will be used to override the HVAC SHUTDN control module and prevent the fans from turning off (refer to *Type Monitor* under the section titled, “Edit Module Screen for Monitor Module” on page 57).

The HVAC OVERRIDE monitor module does not latch when activated. Activating a switch connected to the monitor module will override all HVAC SHUTDN control relay modules in the system, preventing the HVAC SHUTDN modules from activating and causing the FACP LCD to display an active HVAC OVERRIDE module and turn on the Supervisory LED. Releasing the switch will allow the HVAC SHUTDN control relay modules to activate with subsequent events, turning off the fans.

As an example, pressing the HVAC OVERRIDE switch with no fire alarms, duct supervisories, photo supervisories, CO alarms, or CO supervisories in the system will prevent the fans from being turned off when an alarm does occur. As long as the switch is activated, the fans will not shutdown for any alarms. If the system is still in alarm/supervisory condition when the switch is released, the fans will not shutdown unless another alarm/supervisory event occurs after the switch is released.

Important! If an alarm/supervisory event exists in the system and HVAC Shutdown has already occurred, HVAC OVERRIDE will have no effect on the HVAC SHUTDN control relay modules. HVAC OVERRIDE will prevent HVAC Shutdown from occurring only if it is initiated prior to an alarm/supervisory condition.



NOTE: Activation of the HVAC OVERRIDE module causes a supervisory event that will be communicated to the Central Station, if enabled.

Appendix F: Ademco Contact ID Format Event Code Descriptions

This appendix describes the various Event Codes and their messages which are available for the Ademco Contact ID Format.

F.1 Transmission Format Between DACT and Receiver

The transmission string for the Ademco Contact ID Format is as follows:

SSSS 18 QXYZ GG CCC where

SSSS	Four digit Subscriber ID Account Code
18=	Identifies transmission as Contact ID to the receiver at the Central Station
Q=	Event Qualifier where 1 = New Event and 3 = New Restore
XYZ=	Event code
GG=	Group number
CCC=	Zone/Point number

Notes:

1. **18**, which is used in the reporting structure to identify the transmission as Contact ID, is not printed out in the alarm and trouble report.
2. **GG** Group Number is fixed at '00'.
3. **CCC** for Zone or Point Number:
 - ✓ Zone Number is transmitted as '01' for zone 1 up to '49' for zone 49
 - ✓ Point Number is transmitted as '01' for point/address 1 up to '50' for point/address 50

F.2 Ademco Contact ID Typical Printout

A typical printout from a Central Station receiver (such as the Ademco 685) of alarm and trouble reports in the Ademco Contact ID Reporting Structure follows:

Time	Date	Rcvr/Line ID	SSSS	QXYZ	GG	CCCC
11:28	03/25	11	7777	E110	00	C001 - general fire alarm on zone one
11:28	03/25	11	7777	E111	00	C002 - smoke detector alarm on zone two
11:28	03/25	11	7777	E380	00	C003 - fault on zone three
11:28	03/25	11	7777	E570	00	C009 - Zone nine disabled
11:28	03/25	11	7777	R110	00	C001 - Zone one alarm restored
11:28	03/25	11	7777	R111	00	C002 - smoke detector zone two restored
11:28	03/25	11	7777	R380	00	C003 - zone three fault restored
11:28	03/25	11	7777	R570	00	C009 - zone nine reenabled
11:28	03/25	11	7777	E158	00	C006 - high temperature, zone six
11:28	03/25	11	7777	E151	00	C007 - gas detected, zone seven

Notes:

1. **11** is an example of a Receiver/Line Card, showing which receiver and line card the message was transmitted to.
2. **Q**, which is the Event Qualifier for the reporting structure, is printed out in the report as an E for New Event or R for New Restore.

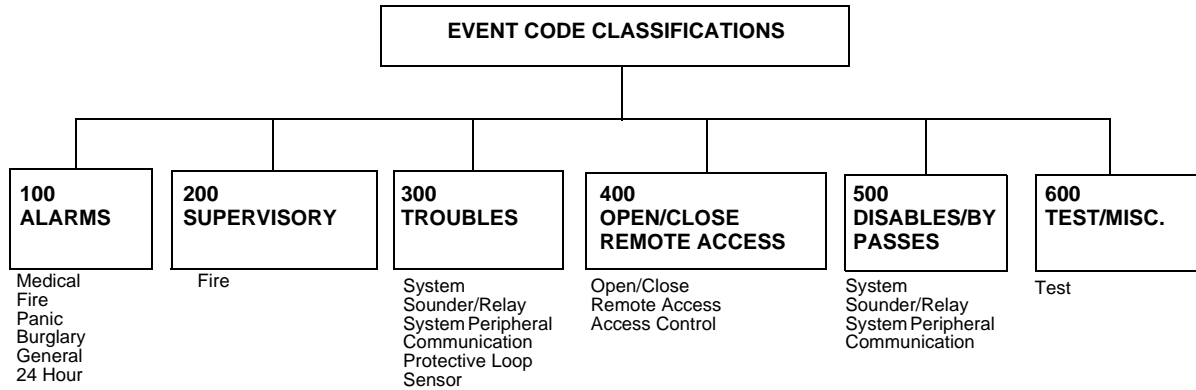

EVENT	MESSAGE
<u>Medical Alarms - 100</u>	
100 Medical	EMERG - Personal Emergency - #
101 Pendant Transmitter	EMERG - Personal Emergency - #
102 Fail to report in	EMERG - Fail to Check-in - #
<u>Fire Alarms - 110</u>	
110 Fire Alarm	FIRE - Fire Alarm - #
111 Smoke	FIRE - Smoke Detector - #
112 Combustion	FIRE - Combustion - #
113 Waterflow	FIRE - Waterflow - #
114 Heat	FIRE - Heat Sensor - #
115 Pull Station	FIRE - Pull Station - #
116 Duct	FIRE - Duct Sensor - #
117 Flame	FIRE - Flame Sensor - #
118 Near Alarm	FIRE - Near Alarm - #
<u>Panic Alarms - 120</u>	
120 Panic Alarm	PANIC - Panic - #
121 Duress	PANIC - Duress - #
122 Silent	PANIC - Silent Panic - #
123 Audible	PANIC - Audible Panic - #
<u>Burglar Alarms - 130</u>	
130 Burglary	BURG - Burglary - #
131 Perimeter	BURG - Perimeter - #
132 Interior	BURG - Interior - #
133 24-Hour	BURG - 24-Hour
134 Entry/Exit	BURG - Entry/Exit - #
135 Day/Night	BURG - Day/Night - #
136 Outdoor	BURG - Outdoor - #
137 Tamper	BURG - Tamper - #
<u>General Alarms - 140</u>	
140 General Alarm	ALARM - General Alarm - #
141 Polling loop open	ALARM - Polling Loop Open - #
142 Polling loop short	ALARM - Polling Loop Short - #
143 Expansion module failure	ALARM - Exp. Module Fail - #
144 Sensor tamper	ALARM - Sensor Tamper - #
145 Expansion module tamper	ALARM - Exp. Module Tamper - #

EVENT	MESSAGE
<u>24-Hour Non-Burglary - 150 and 160</u>	
150 24-Hour Non-Burg	ALARM - 24-Hr. Non-Burg - #
151 Gas detected	ALARM - Gas Detected - #
152 Refrigeration	ALARM - Refrigeration - #
153 Loss of heat	ALARM - Heating System - #
154 Water leakage	ALARM - Water Leakage - #
155 Foil break	ALARM - Foil Break - #
156 Day trouble	ALARM - Day Zone - #
157 Low bottled gas level	ALARM - Low Gas Level - #
158 High Temp	ALARM - High Temperature - #
159 Low Temp	ALARM - Low Temperature - #
161 Loss of air flow	ALARM - Air Flow - #
<u>Fire Supervisory - 200 and 210</u>	
200 Fire supervisory	SUPER. - Fire Supervisory - #
201 Low water pressure	SUPER. - Low Water Pressure - #
202 Low CO2	SUPER. - Low CO2
203 Gate valve sensor	SUPER. - Gate Valve - #
204 Low water level	SUPER. - Low Water Level - #
205 Pump activated	SUPER. - Pump Activation - #
206 Pump failure	SUPER. - Pump Failure - #
<u>System Troubles - 300 and 310</u>	
300 System trouble	TROUBLE - System Trouble
301 AC loss	TROUBLE - AC Power
302 Low system battery	TROUBLE - System Low Battery
303 RAM checksum bad	TROUBLE - RAM Checksum (restore not applicable)
304 ROM checksum bad	TROUBLE - ROM Checksum (restore not applicable)
305 System reset	TROUBLE - System Reset (restore not applicable)
306 Panel program changed	TROUBLE - Prog. Change (restore not applicable)
307 Self-test failure	TROUBLE - Self Test Failure
308 System shutdown	TROUBLE - System Shutdown
309 Battery test failure	TROUBLE - Battery Test Failure
310 Ground fault	TROUBLE - Ground Fault - #
311 No battery	TROUBLE - No Battery
<u>Sounder/Relay Troubles - 320</u>	
320 Sounder/Relay	TROUBLE - Sounder/Relay - #
321 Bell 1	TROUBLE - Bell/Siren #1
322 Bell 2	TROUBLE - Bell/Siren #2
323 Alarm relay	TROUBLE - Alarm Relay
324 Trouble relay	TROUBLE - Trouble Relay
325 Reversing relay	TROUBLE - Reversing Relay
326 Bell 3	TROUBLE - Bell/Siren #3
327 Bell 4	TROUBLE - Bell/Siren #4
<u>System Peripheral Troubles - 330 and 340</u>	
330 System peripheral	TROUBLE - Sys. Peripheral - #
331 Polling loop open	TROUBLE - Polling Loop Open
332 Polling loop short	TROUBLE - Polling Loop Short
333 Expansion module failure	TROUBLE - Expansion Module Failure - #
334 Repeater Failure	TROUBLE - Repeater Failure - #
335 Local printer paper out	TROUBLE - Printer Paper Out
336 Local printer failure	TROUBLE - Local Printer

EVENT	MESSAGE	
<u>Communication Troubles - 350 and 360</u>		
350 Communication	TROUBLE - Communication Trouble	
351 Telco 1 fault	TROUBLE - Phone Line #1	
352 Telco 2 fault	TROUBLE - Phone Line #2	
353 Long range radio transmitter fault	TROUBLE - Radio Transmitter	
354 Fail to communicate	TROUBLE - Fail to Communicate	
355 Loss of radio supervision	TROUBLE - Radio Supervision	
356 Loss of central polling	TROUBLE - Central Radio Polling	
<u>Protection Loop Troubles - 370</u>		
370 Protection loop	TROUBLE - Protection Loop - #	
371 Protection loop open	TROUBLE - Protection Loop Open - #	
372 Protection loop short	TROUBLE - Protection Loop Short - #	
373 Fire trouble	TROUBLE - Fire Loop - #	
<u>Sensor Troubles - 380</u>		
380 Sensor trouble	TROUBLE - Sensor Trouble - #	
381 Loss of supervision - RF	TROUBLE - RF Sensor Supervision - #	
382 Loss of supervision - RPM	TROUBLE - RPM Sensor Supervision - #	
383 Sensor tamper	TROUBLE - Sensor Tamper - #	
384 RF transmitter low battery	TROUBLE - RF Sensor Batt. - #	
<u>Open/Close - 400</u>		
400 Open/Close	OPENING	CLOSING
401 Open/Close by user	OPENING - User #	CLOSING - User #
402 Group Open/Close	OPENING - Group User #	CLOSING - Group User #
403 Automatic Open/Close	OPENING - Automatic	CLOSING - Automatic
404 Late Open/Close	OPENING - Late	CLOSING - Late
405 Deferred Open/Close	Opening not used	Closing not used
406 Cancel	OPENING - Cancel	CLOSING - Cancel
407 Remote arm/disarm	OPENING - Remote	CLOSING - Remote
408 Quick arm	Opening not applicable	CLOSING - Quick Arm
409 Keyswitch Open/Close	OPENING - Keyswitch	CLOSING - Keyswitch
<u>Remote Access - 410</u>		
411 Callback request made	REMOTE - Callback Requested (restore not applicable)	
412 Success - download/access	REMOTE - Successful Access (restore not applicable)	
413 Unsuccessful access	REMOTE - Unsuccessful Access (restore not applicable)	
414 System shutdown	REMOTE - System Shutdown	
415 Dialer shutdown	REMOTE - Dialer Shutdown	
416 Success - upload/access	REMOTE - Successful Access (restore not applicable)	
<u>Access Control - 420</u>		
421 Access denied	ACCESS - Access Denied - User # (restore not used)	
422 Access report by user	ACCESS - Access Granted - User # (restore not used)	
<u>System Disables - 500 and 510</u>		
<u>Sounder/Relay Disables - 520</u>		
520 Sounder/Relay disable	DISABLE - Sounder/Relay - #	
521 Bell 1 disable	DISABLE - Bell/Siren - #1	
522 Bell 2 disable	DISABLE - Bell/Siren - #2	
523 Alarm relay disable	DISABLE - Alarm Relay	
524 Trouble relay disable	DISABLE - Trouble Relay	
525 Reversing relay disable	DISABLE - Reversing Relay	
526 Bell 3 disable	DISABLE - Bell/Siren - #3	

EVENT	MESSAGE
527 Bell 4 disable	DISABLE - Bell/Siren - #4
<u>System Peripheral Disables - 530 and 540</u>	
<u>Communication Disables - 550 and 560</u>	
551 Dialer disabled	DISABLE - Dialer Disable
552 Radio transmitter disabled	DISABLE - Radio Disable
<u>Bypasses - 570</u>	
570 Zone bypass	BYPASS - Zone Bypass - #
571 Fire bypass	BYPASS - Fire Bypass - #
572 24-Hour zone bypass	BYPASS - 24-Hour Bypass - #
573 Burglar bypass	BYPASS - Burg. Bypass - #
574 Group bypass	BYPASS - Group Bypass - #
<u>Test Misc. - 600</u>	
601 Manual trigger test	TEST - Manually Triggered (restore not applicable)
602 Periodic test report	TEST - Periodic (restore not applicable)
603 Periodic RF transmission	TEST - Periodic Radio (restore not applicable)
604 Fire test	TEST - Fire Test (restore not used)
605 Status report to follow	STATUS - Status Follows (restore not applicable)
606 Listen-in to follow	LISTEN - Listen-in Active (restore not applicable)
607 Walk test mode	TEST - Walk Test Mode
608 System abnormal test	TEST - System Abnormal Test

Appendix G: NFPA Requirements

The following is the minimum configuration to meet the NFPA requirements.

Module	Local	Aux	RS	CS	Proprietary	Process Management ¹
NFW-50X	Y	Y	Y	Y	Y	Y
IPOTS-COM (pre-installed communicator)	Y					
4XTM	O	Y	O ²	O	O ²	O
DP-ES-R or DP-ES-B	O	O	O	O	O	O
NFS-LBB ³	O	O	O	O	O	O
N-ANN-LED ³	O	O	O	O	O	Y
N-ANN-80 ³	O	O	O	O	O	Y
N-ANN-S/PG ³	O	O	O	O	O	Y
N-ANN-I/O ³	O	O	O	O	O	Y
N-ANN-RLED ³	O	O	O	O	O	Y
N-ANN-RLY ³	O	O	O	O	O	Y

Where Y = Yes, N = No, and O = Optional

- 1 Non-Emergency
- 2 One of the indicated modules is required when the IPOTS-COM is not employed.
- 3 Listed separately

Appendix H: Open/Short/Ground Trip Values

Table H.1 lists the earth fault resistance detection for each applicable terminal on the FACP.

Output Circuit	Terminal	Trip Resistance (in ohms)
Remote Sync	+	360K
Remote Sync	-	330K
NAC 1-2	+	360K
NAC 1-2	-	320K
ANN Bus	A	270K
ANN Bus	B	265K
Aux Power	+	370K
Aux Power	-	320K
SLC	+	125K
SLC	-	320K

Table H.1 Earth Fault Trip Values

Table H.2 lists the open/short trip values and restoral values for the NAC circuits on the FACP.

Circuit	Trip Resistance (in ohms)	Restore Value
NAC 1-2	Shorts below 1.75K	2K
NAC 1-2	Opens above 25K	23K

Table H.2 NAC Open/Short Trip Values

Index

Numerics

- 24 Hour Test Time **81**
- 24VDC power **68**
- 4XTM module **134, 135**
 - coil resistance **29**
 - current **29**
 - installation **29**
 - installation steps **30**
 - see also Transmitter Module **12**
 - see also transmitter module **16**
 - supervision **68, 76**
 - supervisory relay configuration **31**
 - voltage **29**

A

- AC branch circuit
 - calculations **125**
- AC loss delay **72**
- AC power **23**
 - current **13**
 - current, maximum **23**
 - voltage **13**
 - wiring **13, 23**
- account code **80**
- acknowledge **15, 102**
- add detector **50**
- add module **57**
- addressable **12**
- addressable detectors
 - see also detectors **12**
- addressable device accessories **16**
- addressable modules **16**
 - see also modules **12**
- addressing
 - see also device addressing **68**
 - see also module or detector addressing **16**
- Ademco Contact ID format **142**
- adjective
 - control module **64**
 - list **55**
 - monitor module **60**
 - multiple entries **56**
- alarm **104, 105**
- alarm silence **15, 102**
- alarm verification **12, 53, 107, 109**
- AlarmNet **79**
- ANN-Bus
 - guidelines **18**
 - power **33**
 - primary **86**
 - secondary **13, 86**
- ANN-SB80KIT mounting kit **35**
- annunciator guidelines **18**
- annunciator module **13, 18, 41**
- annunciators **18, 86**
- automatic test operation **107**
- autoprogramming **12, 47, 49**
- autosilence **12, 109**
 - NAC **73**
- auxiliary power **24, 68, 76**

B

- backbox **15**
 - see also cabinet **22**
- banner **68**
 - setting **69**
- battery
 - cable connection **23**
 - charger capacity **13**
 - see also secondary power **13, 23**
- battery box **17**
 - BB-26 **16**
- battery charger **17**
 - disable **13, 68**
 - enable **100**
 - external **17**
- BB-26 **16**
- BB-55F
 - see also battery box **17**

C

- cabinet
 - dimensions **21, 22**
- cabinet mounting **20**
- calculate system current draw **125**
- calculating the battery size **127**
- Canadian option **68, 75**
- CELL-CAB-N **16, 29**
- CELL-MOD **16, 29**
- cellular fault **79**
- central station **78, 79, 80, 120**
 - account code **80**
 - communications **117**
- charger disable **76**
- CHG-120
 - see also battery charger **17**
 - see also remote battery charger **13**
- CHG-75
 - see also battery charger **17**
 - see also remote battery charger **13**
- class A **12, 24**
 - NAC wiring **25**
- class B **12, 24**
 - NAC wiring **25**
- class X **12**
- Classic Loop Interface Protocol **68**
- clock format **70**
- coded operation **108**
- coding
 - NAC **73**
 - two stage operation **74**
- communication format **80**
- communicator
 - replacement **79**
- communicator settings **77**
- control buttons **102**
- control module **16**
 - description display **64**
 - display **62**
 - edit **62**
 - enable/disable **62**

- noun **64**
- noun/adjective **63, 64**
- silenceable **63**
- type **62**
- type codes **63**
- control module delay timer **109**
- correlations **128**
- current
 - availability **14**
 - maximum **14**
- current draw calculations **126**

D

- data
 - see also detector data and sensitivity **107**
- data entry
 - via computer keyboard **46**
 - via keypad **46**
- data values
 - see also detector data and sensitivity **12**
- date setting **70**
- daylight savings time **70**
- DC power
 - non-resettable **24**
 - resettable **24**
 - see also auxiliary DC power **24**
- default programming **133**
- delete detector **51**
- delete module **57**
- description
 - control module **64**
 - detector label **56**
 - monitor module **61**
- detector
 - add **50**
 - adding description **55**
 - delete **51**
 - edit **51**
 - enable/disable **52**
 - screen display **51**
 - type **52**
 - verification **53**
 - wireless **54**
- detector data **107, 115**
 - acceptable range **115**
 - printout **114**
- detector programming **50**
- device addressing **68**
- device IP address **79**
- dimensions
 - cabinet **21**
- DIRTY1 **115**
- DIRTY2 **115**
- disable **65**
 - battery charger **68**
 - charger **68, 76**
- disable point
 - maintenance level **97**
- download **119, 121**
- dress panel **15, 17**

drift compensation **12, 115**
 definition **115**
 drill **15, 102**

E

earth ground **23**
 edit
 control module **62**
 detector **51**
 detector screens **51**
 module, monitor **57**
 enable **65**
 remote sync **68**
 enable/disable
 control module **62**
 detector **52**
 module, monitor **58**
 end-of-line resistor assembly **16**
 English text **68, 76**
 enter key **49**
 EOL-C(R/W) mounting plate **16**
 erase history **77**
 error checking **120**
 Ethernet fault **79**
 event code classification **143**
 event codes **82, 83**
 exiting
 programming **48**
 read status **48**

F

FACP
 see also fire alarm control panel **12**
 features **12**
 fire alarm control panel
 see also FACP **12**
 firmware upgrade **123**
 form-C relay **24**
 French text **68, 76**
 FS-Tools download **119**
 FS-Tools programming utility **15, 16, 56, 119**
 FS-Tools upload **119**
 function keys **68**
 setting **69**
 FWSG **17**
 wiring **45**

G

gains **78**
 gateway IP address **79**
 general alarm zone **60**
 see also zone Z000 **54, 55**
 ground fault **44**
 GSM communicator **16, 29**
 guidelines
 ANN-Bus annunciators **18**

H

hazard condition **106**
 history **77**

erase **77**
 maintenance level **97**
 view events **77**

history file **12**
 HVAC control **140**
 HVAC OVERRIDE **141**
 HVAC RESTART **141**
 HVAC SHUTDN **140**

I

indicators **14**
 installation **20**
 intelligent **12**
 invalid password **95**
 inventory **12**
 INVREP **115**
 IP settings **79**

K

key panel **14**
 function keys **15**
 service/program keys **15**
 keyboard and keypad **46**

L

lamp test **15**
 language **68, 76**
 LCD display **12, 14**
 LED
 AC power **102**
 alarm silenced **103**
 battery **102**
 CO alarm **102**
 communication **103**
 disabled **103**
 fire alarm **102**
 ground **102**
 maintenance **103**
 see also indicators **15**
 supervisory **102**
 trouble **102**
 LED driver **12, 18, 39**
 local alarm zone **66**
 local download **121**
 local energy municipal box service **29**
 local programming **47**
 local upload **121**
 loop setup **67**

M

maintenance alert **12, 107**
 levels **115**
 maintenance program level 2 **48, 97**
 manual programming **47**
 master Program Level 1 **48**
 master program level 1 **49**
 medical alert **106**
 mode key **49**
 module
 add **57**

addressing **16**
 delete **57**
 edit monitor **57**
 enable/disable **58**
 see also addressable modules **16**
 module programming **56**
 monitor module **16**
 adjective **60**
 enable/disable **58**
 noun **61**
 noun/adjective **60**
 type **58**
 type action **59**
 type list **58**
 type selection **59**
 mounting
 cabinet **20**
 main circuit board **20**
 municipal box transmitter
 see also 4XTMF module **29**

N

NAC **13, 72, 73, 107**
 auto silence **73**
 class A wiring diagram **25**
 class B wiring diagram **25**
 coded **108**
 coding **73**
 current **13**
 enable **100**
 enable/disable **72**
 end-of-line resistor **13**
 power **12**
 see also notification appliance circuit **12, 24**
 silence inhibit **74**
 silenceable **73**
 synchronized **107**
 type codes **73**
 voltage drop **13**
 voltage, operating **13**
 wiring style **24**
 NAC options **68**
 N-ANN-100 annunciator module **12, 18**
 N-ANN-80 annunciator module **12, 18, 34, 36**
 N-ANN-I/O LED driver **12, 18, 39**
 N-ANN-LED annunciator module **13, 18, 41**
 N-ANN-RLED annunciator module **13, 18**
 N-ANN-RLY relay module **13, 18, 43**
 N-ANN-S/PG printer module **12, 18, 37**
 NFPA 72 auxiliary fire alarm system **134**
 NFPA 72 central station service (protected premises unit) or remote station service **134**
 NFPA 72 proprietary fire alarm system **134**
 NFPA 72 proprietary protective signaling systems **136**
 NFPA 72 remote station protective signaling system **135**
 NFPA battery requirements **127**
 NFPA standard **134**
 NFS-LBB
 see also battery box **16**

- nonpower-limited
 - relay connections **24**
 - nonresettable power **24**
 - nonsilenceable
 - waterflow **67, 76**
 - normal display **47**
 - normal operation **103**
 - notification appliance circuit **13, 72**
 - see also NAC **12, 24**
 - noun
 - list **55**
 - monitor module **61**
 - multiple entries **56**
 - noun/adjective **55**
 - control module **63**
 - monitor module **60**
- O**
- operating instructions **102**
 - operation
 - alarm **104**
 - CO alarm **105**
 - disable/enable **107**
 - hazard condition **106**
 - medical alert **106**
 - NAC **107**
 - normal **103**
 - process monitor **106**
 - programmed zone **107**
 - supervisory **105**
 - trouble **103**
 - waterflow **107**
 - option modules **16, 29**
 - options **12**
- P**
- panel software
 - upgrade **123**
 - PAS **53, 66, 108**
 - see also positive alarm sequence **12, 53**
 - PAS BYPASS **108**
 - PAS timer **71**
 - password **12, 48, 95**
 - change **95**
 - invalid **95**
 - maintenance level 2 **97**
 - phone line supervision **78**
 - phone number **80**
 - phone settings **78, 80**
 - phone type **78**
 - piezo
 - see also sounder **15**
 - PIN **79**
 - point program **50**
 - positive alarm sequence **53, 108**
 - see also PAS **12**
 - POTS settings **78, 80**
 - power
 - NAC **12**
 - power supply calculations **125**
 - power-limited
 - relay connections **24**
 - power-up
 - first time **48**
 - preferred DNS **79**
 - pre-signal **12, 53, 66**
 - function **108**
 - selection **60**
 - pre-signal Delay timer **71**
 - primary ANN-Bus **86**
 - primary communication path **80**
 - primary phone number **80**
 - primary power
 - see also AC power **23**
 - printer
 - configuration **44**
 - connection **44**
 - setup **44**
 - printer connection **37**
 - printer module **12, 18, 37**
 - printer options **38**
 - process monitor **106**
 - PROCMON AR **75**
 - program
 - check **96**
 - check correlations **96**
 - clear **96**
 - program check
 - maintenance level **98**
 - program keys
 - see also key panel **15**
 - programming **46, 47**
 - annunciators **86**
 - autoprogramming **47**
 - exiting **48**
 - factory default **133**
 - level 1 **48**
 - level 2 **48**
 - manual **47**
 - master level 1 **49**
 - modules **56**
 - off-line computer **47**
 - via computer keyboard **46**
 - via panel keypad **46**
 - programming levels **48**
 - programming screens **48**
 - programming sheets **130**
 - programming utility **15, 16, 56**
 - proprietary yes
 - see also remote upload **119, 121, 123**
- R**
- read status **47, 110**
 - annunciators **113**
 - exiting **48**
 - history **112**
 - NAC **112**
 - print **114**
 - program check **112**
 - relay **112**
 - system point **110**
 - time-date **116**
 - timers **112**
 - trouble reminder **111**
 - zones **111**
- real-time clock **107**
 - recall/increment function **56, 61, 64**
 - receivers **118**
 - relay **13, 24, 75**
 - connections **24**
 - contact rating **13**
 - fixed **24**
 - form-C **13, 75**
 - programmable **12, 24**
 - programming **75**
 - selections **75**
 - trouble **12, 24**
 - relay module **13, 18, 43**
 - relay options **68**
 - remote annunciator **12, 18, 34, 36**
 - remote programming **47**
 - remote station service **29**
 - remote switch functions **12**
 - remote sync **26**
 - enable **68, 100**
 - output **13**
- REN
 - see also ringer equivalence number **19**
- reset **15, 102**
 - resettable power **24**
 - current **24**
 - ringer equivalence number **19**
 - ROME series **43**
- S**
- secondary ANN-Bus **13, 86**
 - secondary communication path **80**
 - secondary power requirements **127**
 - secret code **120**
 - security features **120**
 - sensitivity **107, 115**
 - see also smoke detector sensitivity **107**
 - signal rate **12**
 - signaling line circuit
 - see also SLC **13**
 - silence inhibit **12, 74, 109**
 - silenceable
 - control module **63**
 - NAC **73**
 - waterflow **67, 76**
 - silenceable alarm relay **75**
 - silenceable circuits
 - synchronized signals **73**
 - SLC **12**
 - current **13**
 - reference manual **13**
 - resistance **13**
 - see also Signaling Line Circuit **13**
 - see also signaling line circuit **12**
 - voltage **13**
 - wiring length **13**
 - SLC class **68**
 - SLC loop protocol **68**
 - smoke detector
 - chamber reading **115**

- data **107, 115**
- sensitivity **12, 107**
- software zones **12, 128**
- sounder **15**
- sounder base **54**
 - coding **54**
 - volume **55**
- special purpose zone **65**
- specifications **13**
- static settings **79**
- strobe synchronization **12**
- subnet mask **79**
- subscreen **48**
- supervision
 - 4XTM **68, 76**
 - phone lines **78**
- supervisory **105**
- SUPERVISORY AR **75**
- supervisory relay
 - configuring for 4XTMF **31**
- sync
 - programming **72**
 - see also synchronization **74**
- sync output **13**
 - current **13**
 - end-of-line resistor **13**
 - voltage **13**
- synchronization **26, 107, 112**
 - by manufacturer **75**
 - programming **74**
 - see also strobe synchronization **12**
- synchronized **107**
- synchronized signals **107**
 - and silenceable circuits **73**
- system
 - maintenance level **99**
- system point **110**
- system setup **68**

T

- telephone circuitry **19**
- telephone company
 - rights and warnings **19**
- telephone line **28**
- telephone line supervision **78**
- telephone settings **78, 80**
- test time interval **81**
- time and date
 - maintenance level **100**
- time-date setting **68, 70**
- time-out **120**
- timers **68**
- transmittal priorities **117**
- transmitter module **29**
 - see also 4XTM module **12, 16**
- trouble **103**
- trouble display **103**
- trouble relay **12**
- trouble reminder **68, 109, 111**
- trouble responses **104**
- two-stage operation **66, 74, 101**
- type

- control module **62**
- detector **52**
- monitor module **58**
- NAC **73**
- type code
 - control module **63**
 - supervision **107**
 - verification **12**

U

- UL power-limited wiring requirements **27**
 - see also power-limited and nonpower-limited **24**
- upload **119, 121**
- upload/download **119**
- USB upload/download **121**

V

- verification
 - detector **53**
- view events **77**

W

- walktest **12, 53, 63**
 - maintenance level **99**
 - operation **109**
 - selection **60**
- waterflow
 - nonsilenceable **67, 76**
 - silenceable **67, 68, 76**
- waterflow delay timer **71**
- waterflow retard timer **109**
- wire requirements **138**
- wireless detector **54**
- wireless gateway **17**
 - wiring **45**
- wiring
 - AC power **23**
 - earth ground **23**
 - NAC class A **25**
 - NAC class B **25**
- wiring class **12**

Z

- Z000 **54, 55, 60**
- Z046 **66**
- Z047 **66**
 - PAS zone **53**
- Z048 **66**
 - pre-signal zone **54**
- Z049 **66**
- zone assignment **54, 60, 74**
 - control module **63**
- zone setup **65**
 - maintenance level **100**
- zone type **67**
 - list **67**
- zone Z046
 - local alarm zone **66**
- zone Z047

- PAS zone **53, 66**
- zone Z048
 - pre-signal zone **54, 66**
- zone Z049
 - two-stage zone **66**
- zones **111, 128**
 - disabled **66**
 - enabled **66**
 - installed **66**
 - see also software zones **12**
- zones per device **54**
- zones per sounder base **55**

Slide-in Labels

Carefully cut along the outside of each label. Identify Function (F1-F4) keys as desired and slide the labels into the keypad. Starting at the center of the keypad next to the Function Keys, slide each label into the groove towards the outer edge.

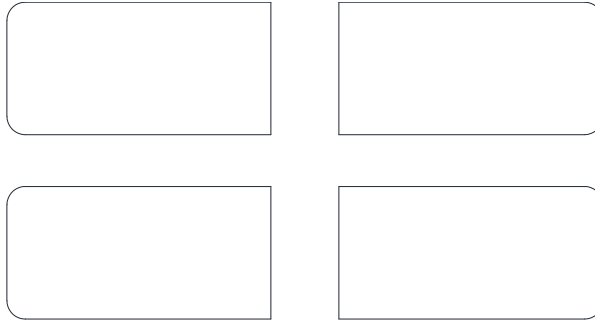

Slide-in Labels

NFW-50X Fire Alarm Control Panel

Operating Instructions

NORMAL - Only *AC POWER* is illuminated green. All other indicators are off. LCD display will read SYSTEM ALL NORMAL.

PANEL KEY - The key to open the panel can be found at the following location:

WHEN AUDIBLE DEVICES ARE SOUNDING - FOR AN ALARM

1. Evacuate the protected area
2. Notify the monitoring service and/or the Fire Department immediately. Tell them briefly what happened and what your current status is.

Phones: _____
Fire Department Monitoring Service

3. If the Fire Department is responding, be prepared to provide directions to arriving firefighters.

FOR TROUBLE, SUPERVISORY, AND EMERGENCY ALARMS

1. Notify the monitoring service and/or applicable first responders if this panel is connected to either one, and tell them what is happening.
2. Silence audible devices by unlocking and opening the panel and pressing the ACKNOWLEDGE/STEP button. The applicable indicator will remain illuminated. Contact authorized service personnel immediately! (See Below).

WARNING!

DO NOT ALLOW TROUBLE CONDITIONS TO REMAIN LOGGED IN THE SYSTEM. THE PROTECTION THE SYSTEM OFFERS HAS BEEN COMPROMISED OR ELIMINATED, WHEN A TROUBLE CONDITION EXISTS.

To return to normal after an alarm

1. Do not enter the protected area until safe to do so.
2. Clear all initiating devices. Smoke detectors will not reset if there is still smoke in the area.
3. Reset the control panel (PRESS the RESET button).

Power failure or brownout

If AC power drops too low or fails, *AC POWER* indicator will extinguish, the system *TROUBLE* indicator will turn on yellow, and the panel buzzer and any other audible trouble devices will sound. Contact authorized service personnel immediately. See below.

Manual activation (Fire Drill or otherwise)

Notification Appliance Circuits (NACs) can be activated by pressing and holding the DRILL button for at least two seconds.

NOTE: You may want to disconnect the municipal box by sliding the DISCONNECT switch, located on the 4XTM module, to its disconnect position (to the right). If a DACT is connected, notify the monitoring service before conducting any fire drills or tests.

Alarm Silencing

Notification Appliance Circuits may be silenced by pressing the ALARM SILENCE button. *ALARM SILENCED* will turn on yellow. Subsequent alarms will reactivate circuits. Press the RESET button to clear the "silenced" condition.

NOTE: Notification Appliance Circuits may be programmed as nonsilenceable. Also, Signal Silence Inhibit, if enabled, will prevent silencing of NACs for five minutes after an alarm (see manual).

To test the indicators, LCD display and piezo

Press and release the RESET button and check all indicators/LEDs. Every indicator/LED should be on, LCD shows all pixels on, piezo sounder beeps.

For more information, refer to the NFW-50X Series Manual, Document #LS10129-001NF-E. It is kept in the following location:

THIS SHEET SHALL BE FRAMED ADJACENT TO THE CONTROL PANEL



In the event of trouble, contact the local Notifier Service Representative

Name: _____

Company: _____

Address: _____

Telephone Number: _____

Cut along dotted line.

Manufacturer Warranties and Limitation of Liability

Manufacturer Warranties. Subject to the limitations set forth herein, Manufacturer warrants that the Products manufactured by it in its Northford, Connecticut facility and sold by it to its authorized Distributors shall be free, under normal use and service, from defects in material and workmanship for a period of thirty six months (36) months from the date of manufacture (effective Jan. 1, 2009). The Products manufactured and sold by Manufacturer are date stamped at the time of production. Manufacturer does not warrant Products that are not manufactured by it in its Northford, Connecticut facility but assigns to its Distributor, to the extent possible, any warranty offered by the manufacturer of such product. This warranty shall be void if a Product is altered, serviced or repaired by anyone other than Manufacturer or its authorized Distributors. This warranty shall also be void if there is a failure to maintain the Products and the systems in which they operate in proper working conditions.

MANUFACTURER MAKES NO FURTHER WARRANTIES, AND DISCLAIMS ANY AND ALL OTHER WARRANTIES, EITHER EXPRESSED OR IMPLIED, WITH RESPECT TO THE PRODUCTS, TRADEMARKS, PROGRAMS AND SERVICES RENDERED BY MANUFACTURER INCLUDING WITHOUT LIMITATION, INFRINGEMENT, TITLE, MERCHANTABILITY, OR FITNESS FOR ANY PARTICULAR PURPOSE. MANUFACTURER SHALL NOT BE LIABLE FOR ANY PERSONAL INJURY OR DEATH WHICH MAY ARISE IN THE COURSE OF, OR AS A RESULT OF, PERSONAL, COMMERCIAL OR INDUSTRIAL USES OF ITS PRODUCTS.

This document constitutes the only warranty made by Manufacturer with respect to its products and replaces all previous warranties and is the only warranty made by Manufacturer. No increase or alteration, written or verbal, of the obligation of this warranty is authorized. Manufacturer does not represent that its products will prevent any loss by fire or otherwise.

Warranty Claims. Manufacturer shall replace or repair, at Manufacturer's discretion, each part returned by its authorized Distributor and acknowledged by Manufacturer to be defective, provided that such part shall have been returned to Manufacturer with all charges prepaid and the authorized Distributor has completed Manufacturer's Return Material Authorization form. The replacement part shall come from Manufacturer's stock and may be new or refurbished. THE FOREGOING IS DISTRIBUTOR'S SOLE AND EXCLUSIVE REMEDY IN THE EVENT OF A WARRANTY CLAIM.

Warn-HL-08-2009.fm

NOTIFIER
12 Clintonville Road
Northford, CT 06472-1610 USA
203-484-7161
www.notifier.com

